

GB

1500W HIGH PRESSURE WASHER

Original Instructions

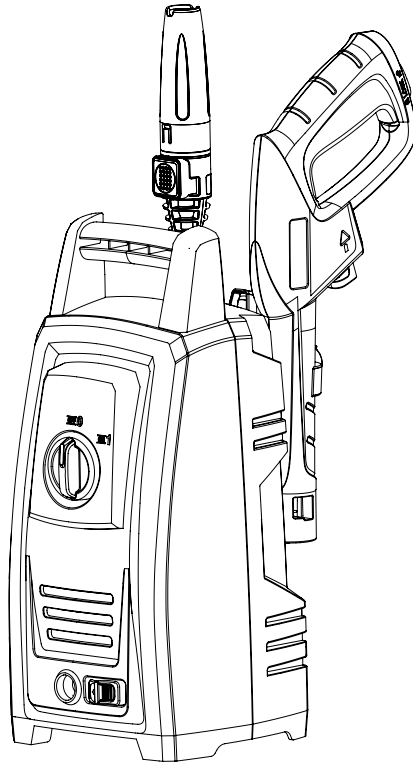

READ & UNDERSTAND INSTRUCTION MANUAL

Save all warnings and instructions for future reference.



SCAN FOR WHATSAPP SUPPORT

YARD FORCE

EW U11P Original Instructions

CONTENT

Intended use	04
Safety	04
Symbols	11
Technical data	14
Product description	15
Installation	16
Operation	19
Maintenance and storage	21
Troubleshooting	23
Declaration of conformity	25
Disposal	27

INTENDED USE

The washer is designed only for cleaning facades, patios, walkways, garden tools, machines, vehicles, tools, etc. It is only intended for private use and is not suitable for commercial use.

Use the washer only as described in this user manual. Any other use is deemed improper and may result in damage to property or even personal injury. The washer is not a children's toy.

The manufacturer or vendor accepts no liability for damage caused by improper or incorrect use.

SAFETY

The following signal words are used in this operating manual.

WARNING!

This signal symbol/word denotes a hazard with an average risk level that could lead to death or severe injury if it is not avoided.

NOTE!

This signal word provides a warning about potential material damage.

SAFETY NOTES



WARNING! RISK OF ELECTRIC SHOCK!

A faulty electrical installation or excessive mains voltage may result in an electric shock.

- An experienced electrician must connect the device to the mains and the connection must meet the requirements of IEC 60364-1.

SAFETY

- It is recommended that the power supply for this washer be supplied either via a fault-current circuit breaker that interrupts the power supply as soon as the leakage current to the earth exceeds 30 mA for 30 ms, or that it be equipped with an earth tester.
- Connect the washer only if the mains voltage of the socket corresponds to the rating plate specification.
- Connect the washer only to an easily accessible socket to allow the washer to be disconnected from the mains quickly in the event of a fault.
- Do not operate the washer if it is visibly damaged or if the mains cord or mains plug is defective.
- If the supply cord of the washer is damaged, to avoid risks it must be replaced by the manufacturer or its After Sales Support or by a person with similar qualifications.
- Do not open the housing; instead, have a qualified professional carry out the repairs. Contact a qualified workshop for this. Liability and warranty claims are waived in the event of repairs performed by the user, improper connection of the device or incorrect operation.
- Only parts that comply with the original device information may be used for repairs. This washer contains electrical and mechanical parts which are essential for providing protection against sources of danger.
- Do not operate the washer with an external timer or separate telecontrol system.
- Do not immerse the washer or the mains cord or mains plug in water or other liquids.
- Never touch the mains plug with damp hands.
- Never pull the mains plug out of the socket by the mains cord; instead, always do so by taking hold of the mains

SAFETY

plug.

- Never use the mains cord as a carrying handle.
- Keep the washer, mains plug and mains cord away from open flames and hot surfaces.
- Lay the mains cord so that it does not pose a tripping hazard.
- Do not kink the mains cord and do not lay it over sharp edges.
- Never store the washer such that there is a risk of it falling into a tub or a basin.
- Under unfavorable mains conditions, voltage drops may occur briefly when starting the device. This may affect other devices (e.g. flashing of a lamp).

With a maximum grid impedance z_{\max} of less than 0.285 ohms, such disturbances are not to be expected. (If necessary, contact your local power company for more information).



WARNING!

Danger for children and persons with impaired physical, sensory or mental capacities (e.g. partially disabled persons, older persons with reduced physical and mental capacities) or lack of experience and knowledge (e.g. older children).

- This washer may be used by persons with impaired physical, sensory or mental capacities or those lacking experience and knowledge if they are supervised or have been instructed in how to safely use the washer and have understood the risks associated with operating it.

SAFETY

- This washer must not be used by children. Children must be supervised to ensure that they do not play with the device.
- Do not leave the washer unattended during operation.
- Do not let children play with the packaging. Children may get caught in it when playing and suffocate.
- Do not allow children to play with the cleaner. Children could swallow small parts and choke.



WARNING! DANGER OF EXPLOSION!

The spraying of flammable liquids can cause an explosion.

- Do not spray any flammable liquids and do not use the washer in explosive environments.



WARNING! RISK OF ELECTRIC SHOCK!

Unsuitable extension cords may be dangerous and could result in an electric shock.

- If an extension cord is used, the mains plug and coupling must be water-tight and must never be placed in water. Use a cord reel that keeps the socket at least 60 mm above the ground.



WARNING! RISK OF INJURY!

High-pressure jets may be dangerous if used improperly.

- The high-pressure jet must not be pointed at persons, active electrical equipment or at the washer itself.
- Do not use the washer within range of other persons

SAFETY

- unless they are wearing protective clothing.
- Do not point the washer at yourself or other persons to clean clothing or footwear.
 - Before first start-up, familiarize yourself with the control elements and safety functions of the washer and the spray gun.
 - When operating the washer, wear suitable personal protective equipment (PPE) such as safety footwear, safety gloves, protective helmets with visor, ear protection, etc.
 - Before you begin any kind of cleaning, check the work area for objects that could pose a risk. Remove all objects that you could stumble over from the work area, e.g. toys or garden furniture.
 - Ensure that you have a stable stance, especially considering the possibility of kickback when you depress the trigger of the spray gun.
 - Be particularly careful when cleaning tires. Car tires and tire valves could be damaged or pop if handled improperly. Discoloration of the tires indicates the first signs of damage.
 - Damaged vehicle tires and tire valves pose a risk to life. Keep the high-pressure jet at a distance of at least 30 cm!
 - The washer must not be used by children or untrained persons.



WARNING! RISK OF INJURY!

Even if you use this washer in compliance with applicable regulations, there are always residual risks. The following risks associated with the construction and design of this washer may occur:

SAFETY

- Injury to health attributed to hand and arm vibrations if the washer is used over a prolonged period of time or if it is not guided and maintained properly.
- Eye injury due to flying parts or particles of dirt blown about by the high-pressure jet. Always wear suitable eye protection when working with the washer.
- Skin injury from accidental contact with the high-pressure jet or from flying parts or particles of dirt blown about by it.
- Always wear suitable protective equipment, clothing and firm footwear when working with the washer.
- Injury to hearing due to noise exposure. Wear suitable ear protection to prevent damage to your hearing when working with the washer.
- The device is equipped with a pressure switch. The threshold is set below the maximum rated pressure. When the water gun is closed, the internal pressure quickly increases until the pressure switch turns off the machine. Opening the water gun will cause the pressure to drop and re-engage the motor.



NOTE! RISK OF DAMAGE!

Improper handling of the washer may result in damage to the washer.

- Do not use the washer if a connection line or important parts of the washer are damaged, e.g. safety equipment, high pressure hoses, spray gun, etc.
- High-pressure hoses, fittings and couplings are important for guaranteeing the safety of the device. Only use high pressure hoses, fittings and couplings recommended by the manufacturer.

SAFETY

- Only use original spare parts from the manufacturer or approved by the manufacturer to guarantee the safety of the device.
- This washer was developed to use the cleaners delivered or recommended by the manufacturer. Using other cleaners or chemicals can affect the safety of the washer.
- Place the washer on a stable, level surface. Operate it in an upright position only and never in a horizontal position.

SYMBOLS

SAFETY SYMBOLS

The purpose of safety symbols is to attract your attention to any possible dangers. The safety symbols and their explanations deserve your careful attention and full understanding. The symbol warnings do not, by themselves, eliminate any danger. The instructions and warnings they give are no substitute for proper accident prevention measures.



WARNING: Be sure to read and understand all safety instructions within this operator's manual, including all safety alert symbols such as "**DANGER**", "**WARNING**", and "**CAUTION**" before using this tool. Failure to follow all instructions listed below may result in electric shock, fire and/or serious personal injury.

SAFETY ALERT SYMBOLS: Indicate **DANGER**, **WARNING**, or **CAUTION**. May be used in conjunction with other symbols or pictographs.

SYMBOL MEANINGS

This page depicts and describes safety symbols that may appear on this product. Read, fully understand and follow all instructions on the appliance before attempting to assemble and operate.

SYMBOLS



Caution! Read the user manual prior to start-up!



This symbol indicates that the mains plug must be disconnected from the power supply immediately if the cord is damaged, twisted or knotted, if it has been severed, or if the washer is left unsupervised, even for a short period of time.



This symbol indicates that the high-pressure jet must never be pointed directly at persons, animals, the washer or the electrical components.



This symbol indicates that the washer must not be connected directly to the drinking water network. If necessary, use it only with a water backflow preventer or an inlet hose set approved in accordance with IEC 61770.



This symbol indicates the loudness of the washer during operation.

SYMBOLS



This symbol indicates that the device complies with the protection class II.

IPX5 Protection against water jets from all directions



Declaration of conformity (see chapter “Declaration of conformity”): Products marked with this symbol meet all the applicable Community regulations of the European Economic Area.









Conforms to relevant UK regulatory requirements.



WEEE symbol. Waste electrical products should not be disposed of with household waste. Please recycle where facilities exist. Check with your Local Authority or local store for recycling guidelines.

TECHNICAL DATA

Model		EW U11P
Power consumption		1500W
Operating pressure: max. pressure		12 MPa (120 bar)
Nominal pressure:		8 MPa (80 bar)
Input pressure/temperature max.		0.6 MPa (6 bar) / 40 °C
Sound power level		$L_{WA} = 87.4 \text{ dB(A)}$
Guaranteed sound power level		$L_{WA} = 92 \text{ dB(A)}$
Sound pressure level		$L_{pA} = 73.4 \text{ dB(A)}$
Vario pressure nozzle		$< 2,5 \text{ m/s}^2$
Turbo nozzle		$< 2,5 \text{ m/s}^2$
Water consumption		max. 6.5 l/min
Protection class		IPX5
Protection class		II
incl. accessories		4.9 kg
Motor specification		Single-phase alternating current motor, 230–240 V~/50 Hz

The values for noise and vibration emissions were determined in accordance with EN 60335-2-79:2012.

DESCRIPTION OF PRODUCT

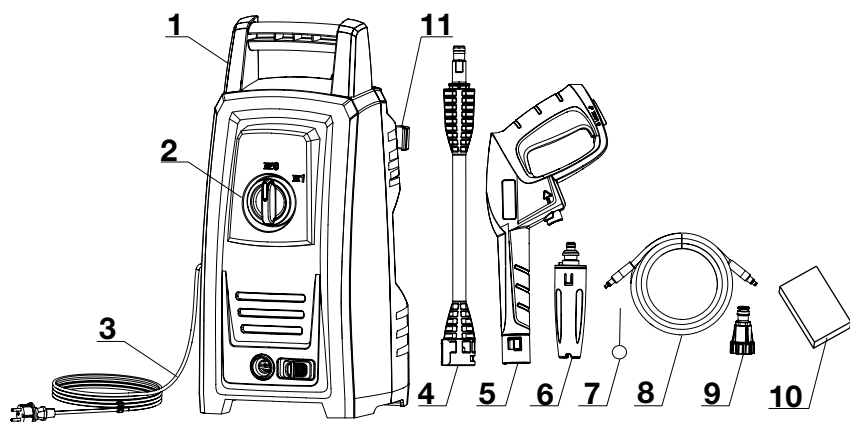

PARTS DESCRIPTION

1. Carry handle
2. ON/ OFF switch
3. Power supply
4. Extension lance
5. Spray gun
6. Variable pressure nozzle
7. Cleaning pin
8. High pressure hose
9. Coupling element for water connection
10. Instruction
11. Attachment plate

INSTALLATION

ASSEMBLY THE ACCESSORIES



WARNING! RISK OF INJURY!

The washer could be inadvertently activated and cause injury. Ensure that the washer is disconnected from the mains before you assemble the washer.

1. Use the screwdriver to screw the carry handle to the main body.
2. Use the screwdriver to screw the attachment plate to the main body.

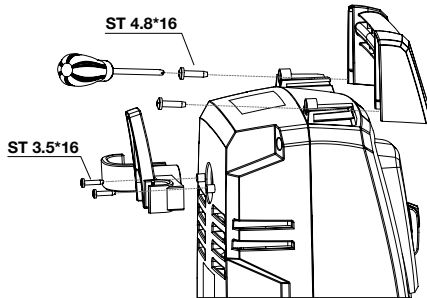

3. Insert the extension lance into the spray gun. Push and turn the extension lance clockwise onto the spray gun until hand tight to lock it in place.

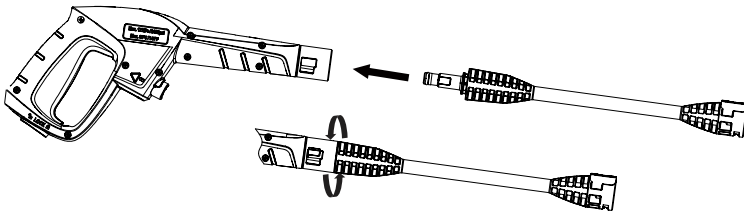

4. Align the lug at the top of the variable pressure nozzle with the lug insert on the top of the extension lance. Push the adjustable variable pressure nozzle into the end of extension lance. An audible click will be heard when it locks into place.

OPERATION

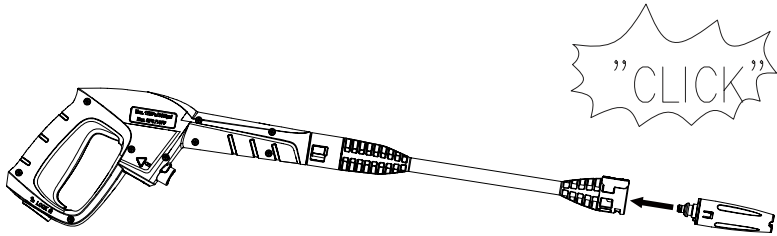

5. Attach the high pressure hose to the spray gun. Insert the quick connect it tight to avoid leakage.

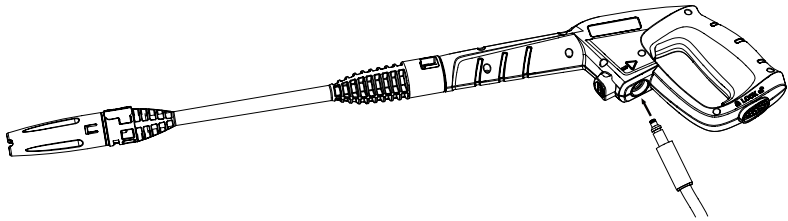

6. Attach the hose connector to pressure washer. Before attaching the connector to the male fitting, remove the plastic cap, which is inserted onto the male fitting on the pressure washer before shipping. This plastic cap can be discarded once removed. After both components have been installed, attach the garden hose with connector screw on the pressure washer. Connect the garden hose to the waterspout.

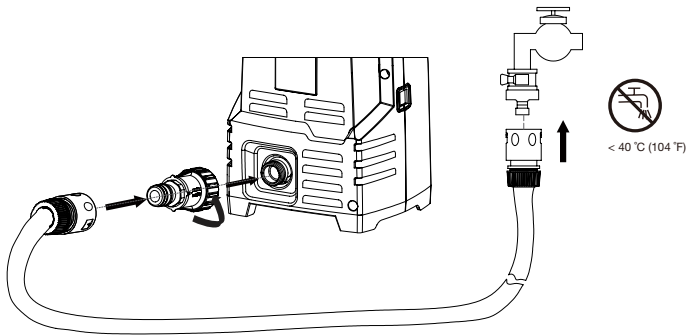

OPERATION



WARNING! HEALTH HAZARD!

The washer must not be directly connected to the drinking water network because the return flow of water poses a risk to the drinking water.

- Use a water backflow preventer or an inlet hose set approved in accordance with IEC 61770.
 - Cleaning car motors and other objects contaminated by oil and various lubricants is permissible only on such areas where the waste water is diverted by an oil separator.
 - Water that has flowed through the backflow preventer is considered unfit for drinking.
7. If the water source is higher than the machine inlet, the water surface shall not exceed 50 cm. to the top surface of the water container at this time cannot install sprinkler, after starting the machine, wait for water to flow out from the gun head, and then connect the nozzle to use.

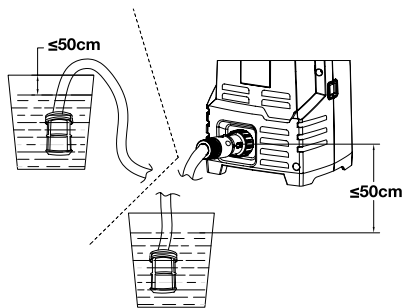

OPERATION

STARTING THE WASHER



NOTE! RISK OF DAMAGE!

Improper handling of the washer may result in damage to the washer.

- Familiarise yourself with all control elements before starting up the washer. Before each use, make sure that the washer is functional.
- Ensure that all parts of the washer are securely attached.
- Ensure that the water connection and the high-pressure hose are not leaking.



NOTE! RISK OF DAMAGE!

Using the washer without water could result in damage to the washer.

- Never operate the washer without water, as dry operation could damage the pump.
 - Use a water filter if the supplied water is contaminated.
1. Connect the power supply.

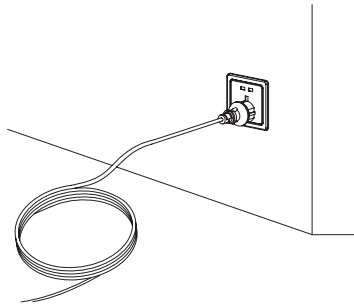

2. Fully open the water tap for the water intake.
3. To switch on the washer, move the ON/OFF switch to ON. The high-pressure pump starts to run.

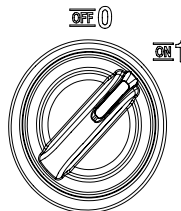
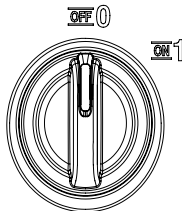

OPERATION

4. Turn the variable pressure nozzle to set the desired water pressure.

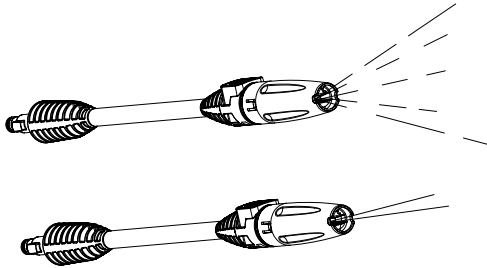

5. Unlock the safety lock of the spray gun by pushing downwards. Press the trigger until a steady stream of water is dispensed. Then let go of the trigger.

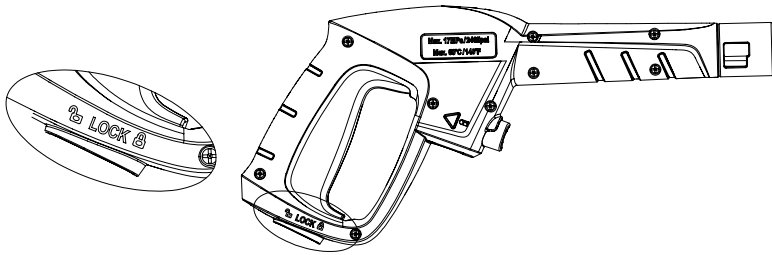

6. To start the cleaning work, hold the spray gun tightly with both hands and press the trigger again.

STOPPING THE WASHER

1. Release the trigger. The high-pressure pump will stop immediately.
2. Move the ON/OFF switch to OFF.
3. Close the water tap for the water inlet.
4. Push the trigger until the pressure in the washer has been released.
5. Lock the trigger by pushing downwards onto the safety lock.



WARNING! RISK OF ELECTRIC SHOCK!

Cleaning and maintenance of the washer while it is connected to the mains may lead to an electric shock.

- Each time before cleaning or maintenance work, switch the washer off and disconnect it from the mains.
- Do not clean the washer with a high-pressure jet.



NOTE! RISK OF DAMAGE!

Improper cleaning may damage the washer.

- Do not use any aggressive cleaners, brushes with metal or nylon bristles or sharp or metallic cleaning utensils such as knives, metal sponges and the like. These can damage the surfaces.

CLEANING THE WASHER

1. Before cleaning, pull the mains plug out of the socket.
2. Wipe the washer and the accessories off with a slightly damp cloth.

CLEANING THE DIRT FILTER

The washer is equipped with a dirt filter to protect the pump. If the dirt filter is not kept clean, the flow of water to the washer will be restricted and the pump could be damaged.

1. Check the dirt filter after each use.
2. Screw off the adapter on the screw connection for the water inlet hose and take out the dirt filter.
3. Rinse out the dirt filter until it is free of dirt and deposits.
4. Insert the dirt filter again and screw the adapter on the screw connection for the water inlet hose tightly.

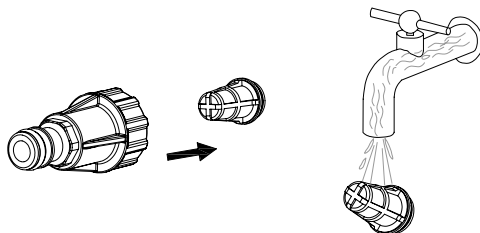

MAINTENANCE AND STORAGE

CLEANING THE HIGH-PRESSURE NOZZLES

1. Remove the cleaning pin from the back of the washer.
2. Use the cleaning pin to clean the high-pressure nozzles of the cleaning attachments.
3. Re-insert the cleaning pin in the rear of the washer.

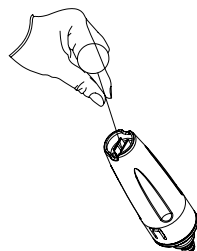

STORAGE



NOTE! RISK OF DAMAGE!

There is always some leftover water in the washer and the pump that could result in damage to the washer.

- Do not store the washer at temperatures below the freezing point, as this may result in frost damage.
- If you take the washer out of commission for a prolonged period of time, empty the cleaner container and let the water drain out of the high-pressure hose.
- Store the washer upright in a dry, well-ventilated location protected from access by children.
- Pay attention to the high net weight of the machine during unpacking, transport and storage.
- Wind the high-pressure hose using the hand crank anticlockwise onto the hose reel.
- Secure the end of the hose with the hose clamp.
- Wind the mains cord around the cord holder at the rear side of the device.
- Store the accessory parts in the compartments provided for this purpose (e.g. holder for the spray gun) on the front and rear side of the washer.

TROUBLESHOOTING



WARNING!

Tampering with the washer could pose a risk to life from electric shock, damage the washer and void warranty claims.

- Do not make any modifications to the washer.

The following table provides assistance in the event of malfunctions. If the solutions provided here are unsuccessful, contact the manufacturer or an authorized service center at the service address specified on the warranty card.

Fault/ malfunction	Cause	Remedy
Device does not work.	The power supply is interrupted.	Check the power connection, mains cord and fuse; have repairs performed by an electrician if necessary.
	The washer is switched off.	Move the ON/OFF switch to ON.
Device does not work.	Individual components are defective.	Contact the manufacturer or an authorized service center at the service address specified on the warranty card.
Washer is working, but keeps cutting out.	The mains cord is damaged.	Contact the manufacturer or an authorized service center at the service address specified on the warranty card.
	An internal electrical connection has become loose.	
	The ON/OFF switch is defective	

TROUBLESHOOTING

Fault/ malfunction	Cause	Remedy
No pressure or only slight pressure is built up.	There is air in the washer.	Operate the washer without connecting the spray gun until the water is dispensed without bubbles.
	There is no water or an insufficient supply of water.	Check your water connection.
		Check the water inlet hose for leaks or blockage.
	The dirt filter is clogged.	Clean the dirt filter; see chapter "Cleaning the dirt filter".
	The washer draws in air.	Check for leaks in the water inlet hose
Large fluctuations in pressure.	The high-pressure nozzle is clogged.	Clean the high-pressure nozzle; see chapter "Cleaning the high-pressure nozzles".
	There is only insufficient water pressure.	Check the water pressure.
	The water inlet hose is kinked.	Check the water inlet hose.
The washer has a leak.	The connections of the water inlet hose are loose.	Tighten the adapter on the screw connection for the water inlet hose and the screw connection on your water tap until hand-tight.
	The pump or the internal connections have a leak.	Contact the manufacturer or an authorized service center at the service address specified on the warranty card.

DECLARATION OF CONFORMITY

Declaration of Conformity

We

MEROTEC GmbH

Otto-Brenner-Str. 8, D-47877 Willich, Germany

Herewith declare under our own, sole responsibility that our product:

High Pressure Water Cleaner

Model no. EW U11P / KSC302-1500

Complies with the following directives:

2006/42/EC Machinery Directive

2014/30/EU EMC Directive

2000/14/EC Noise Directive, amended by 2005/88/EC

Conformity assessment procedure: 2000/14/EC Annex V

Measured sound power level $L_{WA} = 87.4$ dB(A)

Guaranteed sound power level $L_{WA} = 92$ dB(A)

2011/65/EU RoHS

Applied harmonized standards:

EN 60335-1:2012+A16:2023

EN 60335-2-79:2012

EN IEC 55014-1:2021

EN IEC 55014-2:2021

EN IEC 61000-3-11:2019

EN IEC 61000-3-2:2019+A1:2021

MEROTEC GmbH

Otto-Brenner-Str. 8

D-47877 Willich

Place, date: Willich, 28.09.2025

Authorised Signature: _____

Ronald Menken

General Manager



DECLARATION OF CONFORMITY

To the provisions of Council Directives

We
SUMEC UK

Unit A&B Escrick Business Park Escrick, York YO19 6 FD/ United Kingdom

Declare that the product:

Machine Description: 1800W High Pressure Washer

EW U11P / KSC302-1500

Function: Clean the walls of buildings etc.

Complies with the essential health and safety requirements of the following directives:

Supply of Machinery (Safety) Regulations 2008

Electromagnetic Compatibility Regulations 2016

The Restriction of the Use of Certain Hazardous Substances in Electrical and Electronic Equipment Regulations 2012

Noise Emission in the Environment by Equipment for use Outdoors Regulations 2001

Measured Sound Power Level: 87.4 dB (A)

Declared Guaranteed Sound Power Level: 92 dB (A)

Standards and technical specification referred to :

EN 60335-1:2012+A16:2023

EN 60335-2-79:2012

EN IEC 55014-1:2021

EN IEC 55014-2:2021

EN IEC 61000-3-11:2019

EN IEC 61000-3-2:2019+A1:2021

Authorized Signatory

Date: 28.09.2025



Signature: _____

Place: York

Name: Mariana Hall

General Manager

SUMEC UK

Unit A&B Escrick Business Park Escrick

York YO19 6 FD, United Kingdom



DISPOSAL

DISPOSING OF PACKAGING

Dispose of packaging according to type. Sort the paperboard and cardboard as waste paper and the film as recyclable material.

Disposing of the washer

Applicable in the European Union and other European countries with systems for separate collections of recyclable waste.



This symbol indicates that this product may not be disposed of together with domestic waste in compliance with the (2012/19/EU) Regulation pertaining to waste electrical and electronic devices (WEEE). This product must be handed in at a collection point intended for the purpose. This can occur, for example, by handing it in at an authorised collecting point for the recycling of waste electrical and electronic equipment. Owing to potentially hazardous substances that are frequently contained in waste electronic equipment, incorrect handling of waste equipment may have a negative impact on the environment and on the health of human beings. By disposing of this product correctly, you are also contributing towards an efficient use of natural resources. Information on collecting points for waste equipment can be obtained from your local authority, an authorised institution for the disposal of waste electrical and electronic equipment or the waste collection services.