

SOVEREIGN

EASY GARDENING

1400W ELECTRIC PRESSURE WASHER

Item No. 577599

Model No. FB514



Technical Support & Parts

01904 727509

Mon-Fri 9am-5pm Sat-Sun 11am-4pm
www.coreservice.co.uk

ORIGINAL INSTRUCTION MANUAL

Please read these instructions fully before starting assembly.

HHGL Limited, MK9 1BA. HHGL (ROI) Limited, D02 X576

Sep. 20

CONTENTS

General safety warnings	3
Description of symbols	15
Description of product parts	18
In the box	19
Intended use	19
Assembly	20
Operation	22
Technical data	27
Maintenance and storage	28
Troubleshooting	30
Disposal	31
Getting help	31
Warranty	32

GENERAL SAFETY INFORMATION

Safety warnings



DANGER - 'Danger' indicates an imminently dangerous situation which, if not avoided, RESULTS in death or serious injury.



WARNING - 'Warning' indicates a potentially dangerous situation which, if not avoided, MAY RESULT in death or serious injury.



WARNING

The following safety measures must always be observed when using the appliance:

1. Read through all the instructions before using the product.
2. In order to reduce the risk of injury, do not leave the appliance unattended if children are present.
3. ALWAYS unplug the appliance before dismantling or carrying out repairs.
4. Check all safety devices are working correctly before each use. NEVER remove or modify any part of the gun or the appliance.
5. We recommend the use of an earth-leakage protection device (maximum rated breaking current 30 mA).
6. This appliance is designed for use at temperatures between 0 and 40 degrees.

7. Do not use the appliance in extremely cold areas to avoid freezing.
8. Do not use the appliance when you are tired or under the influence of alcohol or drugs.
9. Ensure that the working area is clear of other people.
10. Do not reach too far forward and ensure that you are standing on a stable surface. Ensure that you are always standing securely and not likely to lose balance suddenly.
11. Ensure there is a constant supply of water when the appliance is switched on. Damage may occur if there is no water circulating.
12. Always wear hearing protection, protective eye wear, protective clothing, gloves and safety footwear when using or servicing the appliance.
13. Never have your hands or fingers in front of the spray nozzles when the appliance is switched on.
14. Never try to block or redirect a leak with a part of your body.
15. Always follow the manufacturer's instructions on the label of the cleaning agent. Always protect your eyes, skin and respiratory tracts when using cleaning agents. Avoid skin contact with detergents, in particular contact with eyes! If detergent gets in your eyes flush your eyes with clean water, and seek immediate medical attention.

16. Remain attentive and concentrate at all times while working. Pay attention to what you are doing.

Handle the spray nozzles with care. Do not point the jet towards other people.

This appliance may only be used by adequately-instructed persons.

Always take the gun off the lance before removing dirt from the tip.

Always apply the safety lock on the trigger even if you are only stopping briefly.

Appliances should not be used by children. Children should be supervised to ensure that they do not play with the appliance.

This appliance can be used by people with reduced physical, sensory or mental capabilities or lack of experience and knowledge, if they have been given supervision or instruction concerning the use of the appliance in a safe way and understand the hazards involved.



WARNING - If the cable is damaged, have it replaced by the manufacturer, the manufacturer's repair service or by a specialist with equivalent qualification in order to eliminate any risk.



WARNING - This appliance has been designed for use with the cleaning agent supplied or recommended by the manufacturer. The use of other cleaning or chemical products may adversely affect the safety of the appliance.



WARNING - Misuse of the high-pressure jet can be dangerous. The jet must not be directed at other people, live equipment or the appliance itself.



WARNING - Do not use the appliance if another person is within range unless they are wearing protective clothing.



WARNING - Do not point the water jet at yourself or at others in order to clean off clothing or shoes.



WARNING - Explosion hazard: DO NOT spray flammable liquids.



WARNING - high pressure cleaners must not be operated by children or unqualified persons.



WARNING - High-pressure hoses, fittings and connectors are essential to the safety of the appliance. Use only hoses, fittings and connectors recommended by the manufacturer.



WARNING - Use only original replacement parts or parts approved by the manufacturer in order to ensure appliance safety.



WARNING - Water that has passed through the non-return valves is classed as not for drinking.



WARNING - The plug must be removed from the socket for cleaning or servicing and before switching the appliance to another function.



WARNING - The appliance must not be used if the power cable or another important part of the appliance, e.g. safety devices, high-pressure hose or spray gun is damaged.



WARNING - Always switch off the mains disconnection switch when leaving the appliance unattended.



WARNING - If an extension cable is used, the plug and socket must be watertight.



WARNING - Unsuitable extension cables may be dangerous, if an extension cord is used, it should be suitable for outdoor use, and the connection has to be kept dry and off the ground. It is recommended that this is accomplished by means of a cord reel which keeps the socket at least 60mm above the ground.



WARNING - Depressing the trigger causes recoil in the spraying device. Grip the gun firmly.



WARNING - Do not use pressure greater than the working pressure of one of the components (hoses, fittings, etc.) in the system. Make sure that all equipment and accessory components can withstand the appliance's maximum pressure.



WARNING - Explosion hazard.

Never spray flammable liquids and never use the high pressure cleaner in areas containing combustible dust, vapours or flammable liquid.

Never use the appliance in a closed building or in/near an explosive environment.



WARNING - Do not direct the water jet at electrical equipment or wiring. Never remove the high-pressure hose from the appliance while the system is pressurised. To depressurise the system, first turn off the power and water supply and then activate the trigger 2 or 3 times.

Never keep the trigger mechanism on the gun engaged permanently.

Never operate the appliance without all components properly connected (handle, gun/lance, nozzle, etc.).



WARNING - Equipment damage.

- Check that the product is fitted with its data plate; contact your dealer if it is missing. Products without data plate must not be used, since they cannot be identified and are potentially hazardous.

- ALWAYS turn ON the water supply before turning the high pressure cleaners on. Running the pump dry can cause serious damage to the appliance
- Do not use the high pressure cleaner without the water filter. Keep filter clear of dirt and deposits.
- NEVER operate the high pressure cleaner if components are broken or missing.
- Check equipment regularly and repair or replace worn or damaged components immediately.
- Use only the spray nozzle supplied.
- Never tamper with or adjust the setting of the safety valve or the safety devices.
- Never move the product by pulling on the electrical power lead.
- Do not allow vehicles to drive over the pressure hose.
- Do not move the product by pulling on the pressure hose.
- Never leave the lance unattended while the appliance is running.
- Never attempt to alter the factory settings.
- This can damage the appliance and invalidates the guarantee.
- Always grip the gun and lance firmly when starting and operating the appliance.
- NEVER allow the appliance to run longer than one minute with the trigger in the OFF position. This leads to overheating and damage to the pump.

- The high pressure cleaner is not intended to be used to pump hot water. NEVER connect to the hot water supply. This would substantially reduce the life of the pump.
- NEVER store the high pressure cleaner outside or where it could freeze. This would seriously damage the pump.
- Press the trigger when switching from high to low pressure. Failure to do so may result in damage.
- Be aware of the recoil caused by the water jet when the appliance is switched on.
- Never use the product outdoor in the rain.



CAUTION - Keep hose away from sharp objects. Bursting hoses may cause injury.

Check hose regularly and replace it when damaged.

Do not attempt to repair the damaged hose.



DANGER - Failure to observe these instructions may lead to serious injury and/or death.



WARNING - Reduce the electric shock hazard by keeping all connectors dry and off the floor. Do not touch the plug and/or socket with wet hands.



WARNING - Use the new hoses supplied with the appliance and not the old hoses.



WARNING - During start-up, the product may generate interference on the electricity supply system.



WARNING - Comply with the regulations of the local water supply authority. Under BSEN 12729 (Type BA) the product can be connected directly to the mains drinking water supply only if the supply hose is fitted with a backflow preventer device with drainage facility.



WARNING - Check before each use, and at regular intervals, that all metal fasteners are tight and the products components are in good condition; inspect for broken or worn parts.

PERSONAL SAFETY



WARNING!

RISK OF FATAL INJURY!

- Use special care when cleaning tyres. Vehicle tyres/ tyre valves may become damaged or burst when handled improperly. First signs of damage include discolourations on the tyre. Damaged vehicle tyres/tyre valves pose a life-threatening risk. Keep the jet at a distance of at least 30cm!
- The appliance is not designed for connecting to tap water. If necessary, please use only with a water backflow preventer in conformity with EN12729 type BA.
- Risk of injury, do not directly discharge a stream of water in the direction of another person.
- Know how to stop the product and bleed pressure quickly, be thoroughly familiar with the controls.

OPERATING SAFETY



WARNING!

- For safety reasons, high pressure hoses, valves and couplings must be used with the pressure washer. The new hose-sets supplied with the appliance are to be used. Old hose-sets should not be reused.
- High pressure hose fittings and couplings are important for the safety of the appliance. Use only hose fittings and couplings supplied by the manufacturer.
- The electric supply connection shall be made by a qualified electrician and comply with IEC 60364-1. It is recommended that the electric supply to this appliance should include either a residual current device that will interrupt the supply if the leakage current to earth exceeds 30 mA for 30 ms or a device that will prove the earth circuit.
- Disconnect from the electrical power supply before carrying out user maintenance.
- Do not use the appliance if a supply cord or important parts of the appliance are damaged, e.g. safety devices, high-pressure hoses, trigger gun.
- If an extension cable is used, the plug and socket outlet must be of a watertight construction.
- If the supply cord is damaged, it must be replaced by the manufacturer or its service agent or a similarly qualified person in order to avoid a hazard.

- The PVC or polychloroprene sheathed power cord or extension cables (H05VV-F) are acceptable for use at temperatures at or above 0°C.
- Never carry the appliance by the cable or the hose. Do not carry the equipment with your finger on the On/Off switch when it is connected to the mains.



WARNING!

Remove the plug from the socket:

- When you are not using the equipment.
 - When transporting equipment.
 - When left unattended.
 - When checking or cleaning equipment.
 - When removing blockages or performing maintenance or changing accessories.
 - When the cable is damaged.
 - After contact with foreign bodies.
 - If the appliance begins to vibrate abnormally.
- Do not use the appliance near flammable liquids or gases. In case of nonobservance, there is a risk of fire or explosion occurring.
 - Ensure that the mains voltage matches the information on the label.
 - Before each use check the equipment, power cable and plug for damage, this is to avoid an electrical shock.

- Damaged cables, coupling and plugs or connecting leads that are not compliant with specifications are not to be used. Remove the plug from the plug socket immediately in case of damage or cutting through of the mains cable.
- Do not use the equipment when the switching action of the On/Off switch is impaired. Have damaged switches replaced at our Service Centre.
- Do not overload your appliance. Work only within the indicated range of performance. For heavy work, do not use an appliance with insufficient power. Do not use your appliance for purposes other than those specified.

DESCRIPTION OF SYMBOLS

IMPORTANT!



Please read all of the safety and operating instructions carefully before using this Pressure Washer. Please pay particular attention to all sections of this user guide that carry warning symbols.

WARNING!



This is a warning symbol. This symbol is used throughout the user guide whenever there is a risk of personal injury. Ensure that these warnings are read and understood at all times.



Wear ear protection.



Disconnect the mains plug immediately if the cable is damaged, has been badly twisted or is completely cut through and in the event that the device is left unattended for a short time.



WARNING!

Never direct discharge stream at persons, animals, the unit or electric components.



Appliance not suitable for connection to the potable water mains.

Water that has flown through backflow preventers is considered to be non-potable.

The appliance is not intended to be connected to the potable water mains. If necessary, please use only inlet hose-set approved by IEC 61770.



Guaranteed sound power level value in 96 dB(A).



"I" Means ON
"O" Means OFF



Class II appliance.



The product complies with the appliance European directives and an evaluation method of conformity for these directives was completed.



Recycle unwanted materials instead of disposing of them as household waste. All tools, cables and packaging should be sorted, taken to the local recycling centre and disposed of in an environmentally-friendly way.

SAFETY DEVICES

This product is equipped with several safety devices to avoid damage and injuries.

Overload cut-out

In case of overload, the motor stops. In this case, switch the product off, remove the mains plug and let it cool down, then repeat the start-up.

Trigger lock

The spray gun is equipped with a trigger lock in order to prevent accidental activation of the trigger.

Safety valve

The safety valve is a pressure limiting valve. When the trigger is released, the valve opens and discharges the pressure inside the pump.

Automatic motor start-stop device

Automatic motor start-stop device is operated by the trigger of the spray gun.

When the trigger is released the dynamic pressure automatically cuts out the motor.

When the trigger is depressed the automatic drop in pressure starts the motor and the pressure is restored after a very slight delay.

DESCRIPTION OF PRODUCT PARTS

Parts

1. On/Off switch
2. Pressure washer gun storage
3. Handle
4. Cable hook
5. Detergent bottle
6. Water outlet
7. Inlet adapter
8. Spray gun
9. Trigger
10. Safety lock-off button
11. High pressure hose
12. Spray lance
13. Nozzle clean pin

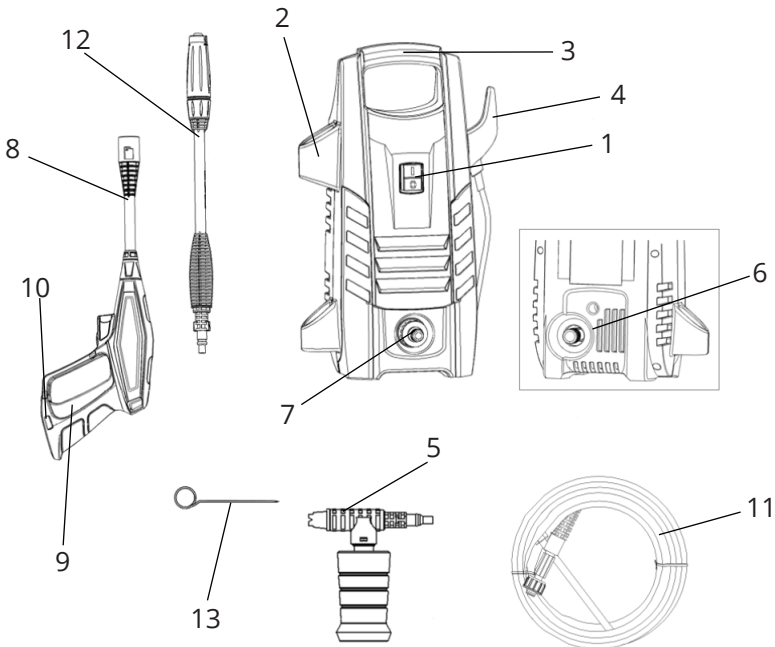

IN THE BOX

Parts

- High-pressure washer
- High pressure hose
- 1 x Spray gun
- 1 x Spray lance
- 1 x Nozzle clean pin
- 1 x Detergent bottle
- Operating manual

If any parts are missing or damaged, please make contact with your local store.

INTENDED USE

This high-pressure washer is designed for domestic use only:

- To clean appliances, vehicles, buildings, tools, facades, terraces, garden equipment, etc., use a high-pressure water jet (and detergents if required).
- To use with accessories, replacement parts and detergents approved by Sovereign.
- Observe the instructions provided with these detergents.
- Any use of the appliance that deviates from its intended use and is not included in these instructions is considered unauthorised use and relieves the manufacturer from their legal liability.

ASSEMBLY



WARNING!

Make sure the pressure washer is switched OFF and disconnected from the mains power supply before starting to prepare for the below procedures.

To prepare the pressure washer for use, proceed as follows:

1. Connect the end of the high pressure hose firmly into the trigger assembly. See figure 1 and 2.

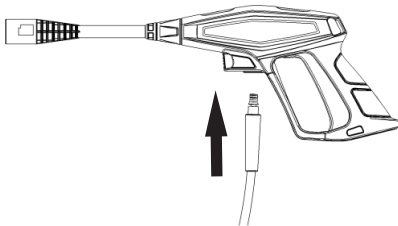

Figure 1

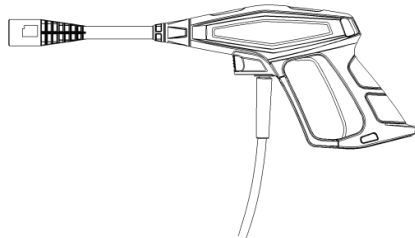

Figure 2

2. Screw the connector onto the end of the high pressure hose and trigger assembly onto the water outlet pipe. See figure 3 and 4.

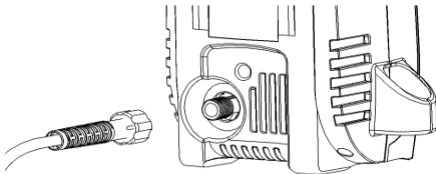

Figure 3

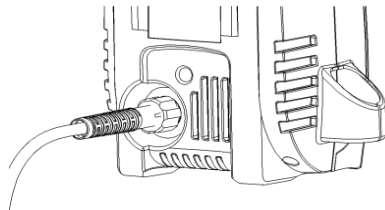

Figure 4

3. Tighten the connector by hand only.

4. Push the trigger lock button through the switch lever to lock the trigger to the OFF position. See figure 5.

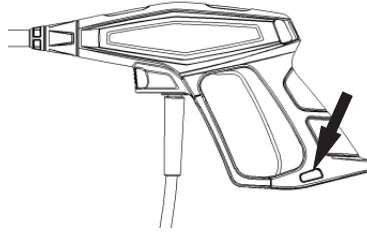

Figure 5

5. Connect the water supply hose to the water inlet connector. See figure 6 and 7. The water supply hose is not provided with the pressure washer contents.

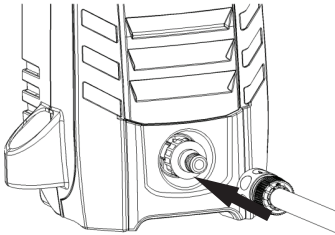

Figure 6

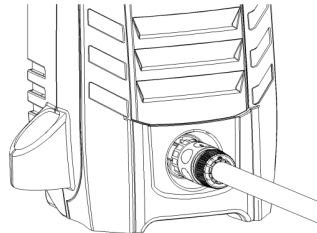

Figure 7



WARNING!

The temperature of the incoming water supply must not exceed 40°C.

6. Connect the spray lance to the high pressure hose and spray gun assembly. See figure 8 and 9.

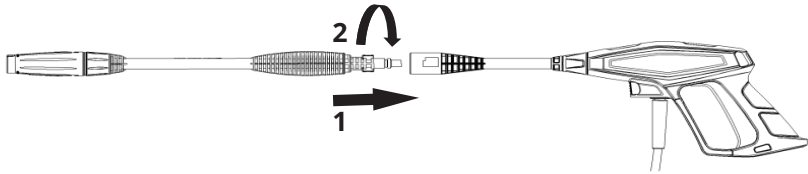

Figure 8

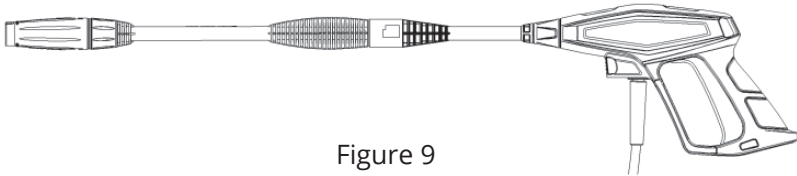

Figure 9

OPERATION

Start-up



WARNING!

Always turn off the motor before turning off the water supply to the pressure washer. Running the pressure washer without water can cause serious damage.

1. Turn the water supply tap fully on.
2. Plug the mains power cable into the socket.
3. Release the trigger lock. See figure 10.
4. Press the ON/OFF switch to the ON position (marked I). See figure 11.

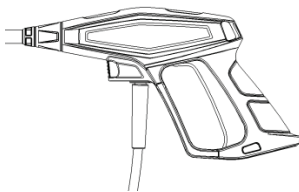

Figure 10

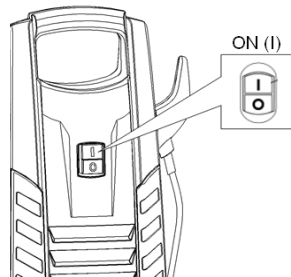

Figure 11

Adjusting the spray

The nozzle on spray lance is adjustable to allow you to adjust the spray from a tight beam of water to a wide spray.

To adjust the nozzle, proceed as follows:

1. Hold the shaft of the lance in one hand.
2. Twist the nozzle with the other hand. See figure 12.
3. The tight beam should be used to clean small areas where a small spray is required.
4. The wide beam should be used for cleaning large areas.

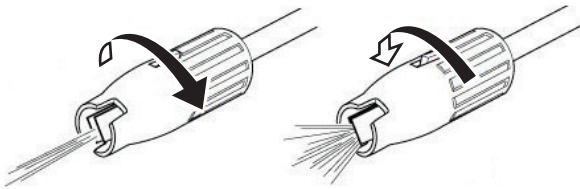

Figure 12

Total stop system

The pressure washer is fitted with a total stop system to protect the motor when in use.

When the trigger is released the motor will stop.

When the trigger is squeezed the motor will start up again.



Caution!

Some painted or treated surfaces may be susceptible to damage from the high pressure jet washer.

When cleaning vehicles for example, always check with the manufacturer whether surfaces are suitable for pressure cleaning or whether any restrictions apply.

Some useful general precautions are:

Never position the nozzle nearer than 30cm to the area being cleaned (If in doubt test on a small area first).

Never use the pressure washer on areas with loose paint or poorly secured trims/fittings.

Always keep the water jet moving over the surface. Do not leave the jet in the same position for a prolonged period as this could cause damage to the surface.

To be sure always check with the suppliers of the item to be cleaned that surfaces are suitable for pressure jet washing.



WARNING!

Before using the pressure washer make sure that there are no other people or animals in the work area.

Press the High-pressure washer ON

To safely turn the pressure washer on, please follow the below instructions.

1. Make sure that the pressure washer has been correctly assembled and prepared for use.
2. Press the ON/OFF switch to ON position marked as I. (Figure 11 above)
3. Adjust the spray.
4. Release the trigger lock and point the nozzle at the area to be cleaned.
5. Squeeze the trigger.
6. Proceed with the clean.

Press the High-pressure washer OFF after use

When you have finished using the pressure washer, follow the procedure shown below to switch OFF and disconnect the unit.

1. Press the ON/OFF switch to the OFF position marked O. See figure 13.
2. Turn off the water supply at the tap.
3. Discharge the water in the pump and the high pressure hose by squeezing the trigger for a few seconds or until nothing is coming out.
4. Lock the trigger in the OFF position.
5. Disconnect from the mains power supply.

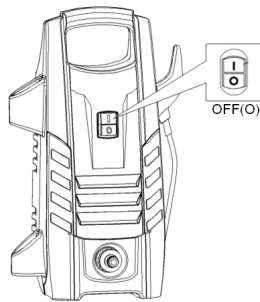

Figure 13



WARNING!

Before using the detergent bottle, make sure that there aren't any people or domestic animals in the work area.



WARNING!

Never remove the high-pressure hose from the appliance while the system is pressurised. To depressurise the system, switch off first the motor and then the water supply. Then depress the trigger 2 or 3 times.

Fitting the detergent bottle

To fit the detergent bottle please follow the below instructions:

1. Make sure that the trigger is locked in the OFF position.
2. Fill the bottle with suitable biodegradable detergent.
3. Fit the detergent spraying nozzle to the bottle by inserting the detergent delivery tube into the bottle and screwing the nozzle on to the head of the bottle. See figure 14.
4. Connect the detergent spraying nozzle to the high pressure hose and spray gun assembly. See figure 15.
5. Release the trigger lock and point the nozzle at the area to be sprayed.
6. Squeeze the trigger.
7. Proceed with the clean.

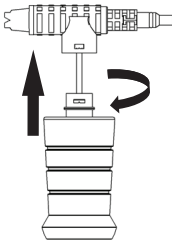

Figure 14

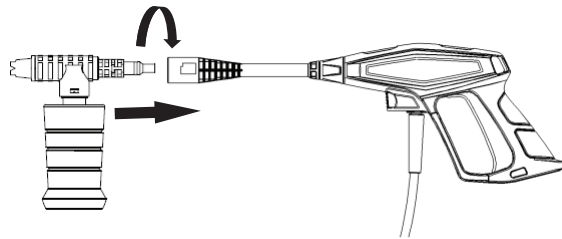

Figure 15

TECHNICAL DATA

Model	FB514
Rated voltage	230-240V~, 50Hz
Rated input power	1400W
Working pressure	6 MPa
Max. pressure	9 MPa
Flow rate	4.5l/min
Weight	4.8Kg
IP degree of protection	IPX5
Safety class	▣ / II
Inlet water temperature (max.)	40 °C
Max. inlet pressure	0.6MPa
Vibration	≤2.5m/s ²
Measured sound pressure level	81 dB (A), K=3 dB (A)
Guaranteed sound power level	96 dB (A)

The sound intensity level for the operator may exceed 80 dB(A) and ear protection measures are necessary.

The declared vibration value has been measured in accordance with a standard test method (according to EN 60335-2-79) and may be used for comparing one product with another. The declared vibration value may also be used in a preliminary assessment of exposure.



WARNING!

Depending on the actual use of the product the vibration values can differ from the declared total! Adopt proper measures to protect yourself against vibration exposures! Take the whole work process into consideration, including times the product is running under no load or switched off.

Proper measures include among others regular maintenance and care of the product and cutting attachments, keeping hands warm, periodical breaks and proper planning of work processes!

MAINTENANCE AND STORAGE



WARNING!

Before starting any cleaning or maintenance procedure on the pressure washer, ensure the spray nozzle is disconnected from the spray gun.

Keep the body of the pressure washer clean and free from debris.

The high pressure hose and spray gun assembly and the lance should also be kept clean.

Regular cleaning of the nozzle is important to the efficient running of the pressure cleaner. The nozzle is cleaned at regular intervals using the nozzle cleaner provided. See figure 16.

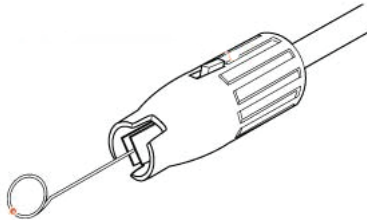

Figure 16

Any worn or damaged parts should be replaced by qualified personnel.

If the mains cable is damaged it must be replaced by the manufacturer or its service agent or similarly qualified person to avoid a hazard.

There are no user serviceable parts inside this washer. Refer to qualified service personnel if internal maintenance is required.

If you need to replace the fitted plug, then follow the instructions below.

IMPORTANT: The wires in the mains lead are coloured in accordance with the following code:

Blue – Neutral / Brown – Live

As the colours of the wire in the mains lead of this product may not correspond with the coloured markings identifying the terminals in your plug, proceed as follows. The wire, which is coloured blue, must be connected to the terminal, which is marked with N or coloured black. The wire, which is coloured brown, must be connected to the terminal, which is marked L or coloured red.

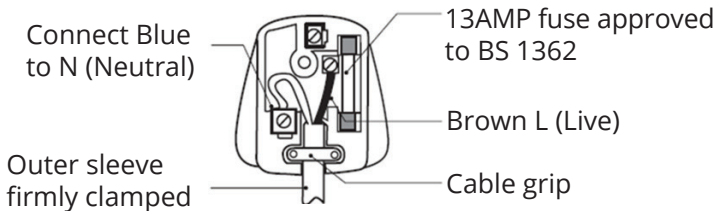

WARNING!

Never connect live or neutral wires to the earth terminal of the plug.

Storage

Disconnect the high pressure hose and spray gun assembly and the nozzle, and store them carefully in a secure dry place.

Always store the pressure washer out of the reach of children.

Avoid storing the pressure washer in temperatures below 5°C.

Make sure that the pressure washer, the trigger assembly and the lance have been thoroughly cleaned before storing.

TROUBLESHOOTING

1) No power.

- Check the plug socket, cable, line and plug, where appropriate, have repaired through an electrical specialist.
- Any of the parts are defective, such as On/Off switch / motor, etc. (please contact the service agent).

2) The High-pressure washer operates intermittently.

- Power cable is damaged.
- Internal loose electrical connection.
- On/Off switch defective (please contact the service agent).

3) None or only little pressure is built up.

- Check if there is any air in the system, if so, please ventilate the appliance! Run the appliance without the high pressure hose connected until water starts leaking without bubbles. Re-attach the high pressure hose.
- Check all inlet pipes leading to the pump for leaks or clogs.
- Check the setting on the hand-held spray gun.

4) Different pressure varieties.

- Clean the high pressure jet nozzle
- Check the water inlet pressure.

5) Appliance is leaking.

- Please contact the authorised agent.

DISPOSAL

The High-pressure washer and its accessories are made of various recyclable materials. Dispose of the high pressure washer in accordance with your local recycling regulations.

GETTING HELP

Our dedicated UK-based customer helpline is open 7 days a week to assist you with assembly, parts queries and technical support. We are open during office hours but you can always send an email via **support@coreservice.co.uk**. Our experts are here to get you back enjoying your garden in no time.

For useful assembly, starting and maintenance videos, and ordering spares, please visit **www.coreservice.co.uk**.

Calling our service does not affect your statutory rights.

WARRANTY

This product is covered by a 1 year warranty.

The warranty covers any manufacturing defect in materials, workmanship and finish.

Any claim under this warranty must be made by going to your nearest Homebase store, taking your proof of purchase with you, and claims must be made within 1 year of the date of purchase.

We will offer you a free repair of the item where this is possible, or a replacement or a refund. Your statutory rights remain unaffected, in particular any rights you may have under the Consumer Rights Act 2015.

This warranty is given by HHGL Limited, MK9 1BA, HHGL (ROI) Limited, D02 X576.

Please note: This warranty does not apply to products misused or neglected and only covers domestic use. It does not apply to commercial use of the product. In addition, the warranty will be void for the following reasons: Any damage resulting from product misuse or product neglect.