



SPEAR & JACKSON

**INSTRUCTION
MANUAL**

CORDLESS GARDEN SAW

**10.8V
BGS108**



AFTERSALES SERVICE
01904 727505
MON-FRI 9am-5pm SAT/SUN 11am-4pm
www.spearandjackson-power.com



Important - Please read these instructions fully before operating or maintaining your garden saw.

These instructions contain important information that will help you get the best from your 10.8V garden saw, protecting your power tool investment.

THANK YOU!

Dear Customer,

Thank you for choosing a Spear and Jackson 10.8V garden saw. Spear and Jackson was founded in 1760 in the city of Sheffield, which is world famous for the production of steel, cutlery and garden and hand tools.

Through continuous innovation and the use of new technologies and materials, Spear and Jackson has gained an enviable reputation as a supplier of reliable, high performance and high quality products designed to make your work in the garden as easy and enjoyable as possible.

3 YEARS GUARANTEE

As a testament to the quality of our products, we offer a free extension of the standard 2 years manufacturer's warranty for all registered products. Simply register your product within 28 days of purchase via www.spearandjackson-power.com to extend the standard manufacturer's warranty by an additional 12 months. After registering your product, your garden power tool will be covered for parts and labour for 3 years from the date of purchase, subject to the terms of the warranty. If you do not register your product, it is important to retain your proof of purchase.

7 DAYS A WEEK TECHNICAL SUPPORT

We want you to get the best out of your products. Our easy-to-read instruction manual guides you with best practice use and maintenance tips. You can also visit www.spearandjackson-power.com for online help, general tips and useful videos about your garden product. However if you prefer to speak to one of technicians please call **01904 727505, Mon-Fri 9am-5pm and Sat-Sun 11am-4pm**, we can solve the majority of questions directly over the phone.

We hope you enjoy your product and look forward to your feedback.

CONTENTS

Safety Information	04
Description of symbols	04
Symbols on the unit	04
Symbols on the charger	04
Symbols on the battery pack	05
Safety	05
Work area safety	05
Electrical safety	06
Operational safety	06
Power tool use and care	07
Battery power tool use and care	08
Service	08
Maintenance and storage	08
Safety warning for battery	09
Safety warning for chargers	09
Vibration and noise reduction	10
Residual risks	10
Intended use	11
Box Content	12
Assembly	13
Preparation	16
Operation	18
Maintenance	20
Technical Data	23
Troubleshooting	25
Warranty	26
EC DECLARATION OF CONFORMITY	27

SAFETY INFORMATION

Please read these instructions fully before operating or maintaining your machine

DESCRIPTION OF SYMBOLS

The following warning symbols appear throughout this manual and indicate the appropriate safety measures you should take when operating and maintaining the cordless garden saw.

SYMBOLS ON THE UNIT



WARNING!

This is a warning symbol. This symbol is used throughout the user guide whenever there is a risk of personal injury. Ensure that these warnings are read and understood at all times..



Read operating manual before use.



Conforms to all relevant safety standards.



Do not use the power tool in the rain or leave it outdoors when it is raining.



Objects thrown by the product could hit the user or other bystanders. Always ensure that other people and pets remain at a safe distance from the product when it is in operation. In general, children must not come near the area where the product is being used.



Wear protective gloves.



Wear eye protection.



Wear dust mask protection.



Keep fingers away from the moving cutting device!



Recycle unwanted materials instead of disposing of them as waste. All tools and packaging should be sorted, taken to the local recycling centre and disposed of in an environmentally safe way.

SYMBOLS ON THE CHARGER



The charger is for indoor use only.



Double insulation II.



Pole orientation.

T2A



Protective 2A limited

SAFETY INFORMATION

Please read these instructions fully before operating or maintaining your machine

SYMBOLS ON THE BATTERY PACK



Do not dispose batteries in water.



Do not dispose batteries in household fire.



Do not subject the battery to strong sunlight over long periods and do not leave it on a heater(max.45 °C)



Take batteries to an old battery collection point where they will be recycled in an environmentally friendly manner.



Never dispose of rechargeable batteries in your household refuse! Faulty or used rechargeable batteries must be recycled in accordance with Directive 2006 / 66 / EC. Return the rechargeable battery pack and / or the tool via the recycling facilities provided.

Keep all safety advice and instructions in a safe place for future reference. The term “power tool” in warnings refers to your mains-operated (by means of a mains lead) power tool or battery-operated power tool (without a mains lead).

WORK AREA SAFETY

- **Keep work area clean and well lit.** Cluttered or dark areas invite accidents.
- **Do not operate power tools in explosive atmospheres, such as in the presence of flammable liquids, gases or dust.** Power tools create sparks which may ignite the dust or fumes.
- **Keep children and bystanders away while operating a power tool.** Distractions can cause you to lose control.

SAFETY



WARNING!

Read all safety warnings and all instructions. Failure to follow the warnings and instructions may result in an electric shock, fire and/or serious injury.

SAFETY INFORMATION

Please read these instructions fully before operating or maintaining your machine

ELECTRICAL SAFETY

- **The power tool plugs(or on the power supply) must match the mains socket. Never modify the plug in any way. Do not use any adapter plugs with earthed (grounded) power tools.** Unmodified plugs and matching outlets will reduce risk of electric shock.
- **Avoid body contact with earthed or grounded surfaces, such as pipes, radiators, ranges and refrigerators.** There is an increased risk of an electric shock if your body is earthed or grounded.
- **Do not expose power tools to rain or wet conditions.** Water entering a power tool will increase the risk of electric shock.
- **Do not abuse the cord. Never use the cord for carrying, pulling or unplugging the power tool. Keep cord away from heat, oil, sharp edges or moving parts.** Damaged or entangled cords increase the risk of electric shock.
- **When operating a power tool outdoors, use an extension cord approved for outdoor use.** Use of a cord suitable for outdoor use reduces the risk of electric shock.
- **If operating a power tool in a damp location is unavoidable, use a residual current device (RCD) protected supply.** Use of an RCD reduces the risk of electric shock. NOTE the term “residual current device (RCD)” may be replaced by the term “ground fault circuit interrupter (GFCI)” or “earth leakage circuit breaker (ELCB)”.

OPERATIONAL SAFETY

- **Stay alert, watch what you are doing and use common sense when operating a power tool. Do not use a power tool while you are tired or under the influence of drugs, alcohol or medication.** A moment of lapsed concentration while operating power tools may result in serious personal injury.
- **Use personal protective equipment. Always wear eye protection.** Protective equipment such as dust mask, non-slip safety shoes, hard hat, or hearing protection appropriate for the type of power tool and working conditions will reduce personal injuries.
- **Prevent unintentional starting. Ensure the switch is in the off-position before connecting to power source and/or battery pack, picking up or carrying the tool.** Never carry power tools with your finger on the switch or energizing power tools that have the switch on invites accidents.
- **Remove any adjusting key or wrench before turning the power tool on.** A wrench or a key left attached to a rotating part of the power tool may result in personal injury.
- **Do not overreach. Keep proper footing and balance at all times.** This enables better control of the power tool in unexpected situations.
- **Dress properly. Do not wear loose clothing or jewellery. Keep your hair, clothing and gloves away from moving parts.** Loose clothes, jewellery or long hair can be caught in moving parts.

SAFETY INFORMATION

Please read these instructions fully before operating or maintaining your machine

- **If devices are provided for the connection of dust extraction and collection facilities, ensure these are connected and properly used.** Use of dust collection can reduce dust-related hazards.
- **Keep hands away from the sawing area. Do not grip the underside of the work piece.** Contact with the saw blade can lead to injuries.
- **Keep hands away from the lifting rod and the quick-action blade clamp.** Contact with the saw blade may result in injury.
- **Apply the machine to the work piece only when switched on.** Otherwise there is danger of kickback when the cutting tool jams in the workpiece.
- **When the cut is completed, switch off the machine and then pull the saw blade out of the cut only after it has come to a standstill.** In this manner you can avoid kickback and can place down the machine securely.
- **Use only undamaged saw blades that are in perfect condition.** Bent or dull saw blades can break, negatively influence the cut, or lead to kickback.
- **After switching off do not stop the saw blade by pressing it sideways against an object.** The saw blade could be damaged, brake, or cause kickback. Do not brake the saw blade to a stop by applying side pressure after switching off. The saw blade can be damaged, break or cause kickback.
- **Secure the material well. Do not support the work piece with your hand or foot.**

Do not touch objects or the floor with the saw running. Danger of kickback.

- **Secure the workpiece.** A workpiece clamped with clamping devices or in a vice is held more secure than by hand.

POWER TOOL USE AND CARE

- **Do not overload the power tool. Use the correct power tool for your application.** The correct power tool will do the job better and safer at the rate for which it was designed.
- **Do not use the power tool if its switch is defective.** Any power tool that cannot be controlled with the switch is dangerous and must be repaired.
- **Disconnect the plug from the power source and/or the battery pack from the power tool before making any adjustments, changing accessories, or storing power tools.** This precaution is intended to prevent the device from unintentionally starting.
- **Store idle power tools out of the reach of children and do not allow persons unfamiliar with the power tool or these instructions to operate the power tool.** Power tools are dangerous in the hands of untrained users.
- **Maintain power tools. Check for misalignment or binding of moving parts, breakage of parts and any other condition that may affect the power tool's operation. If damaged, have the**

SAFETY INFORMATION

Please read these instructions fully before operating or maintaining your machine

power tool repaired before use. Many accidents are caused by poorly maintained power tools.

- **Keep cutting tools sharp and clean.** Properly maintained cutting tools with sharp cutting edges are less likely to bind and are easier to control.
- **Use the power tool, accessories and tool bits etc. in accordance with these instructions, taking into account the working conditions and the work to be performed.** Use of the power tool for operations different from those intended could result in a hazardous situation.

happens, avoid contact with the fluid. If contact occurs, flush the affected area with water. Seek additional medical help if any of the fluid gets into your eyes. Escaping battery fluid may cause skin irritation or burns.

SERVICE

- **Have your power tool serviced by a qualified repair person using only identical replacement parts.** This will ensure that the safety of the power tool is maintained.

BATTERYPOWER TOOL USE AND CARE

- **Recharge only with the charger specified by the manufacturer.** A charger that is suitable for one type of battery pack may create a risk of fire when used with another battery pack.
- **Use power tools only with specifically designated battery packs.** Use of any other battery packs may create a risk of injury and fire.
- **When battery pack is not in use, keep it away from other metal objects, like paper clips, coins, keys, nails, screws or other small metal objects, that could cause the contacts to be bridged.** Short circuiting the contacts of a rechargeable battery unit may result in heat damage or fire.
- Fluids may leak out of rechargeable battery units if they are misused. If this

MAINTENANCE AND STORAGE

- **Maintain tools with care.** Keep tools clean and in good condition for better and safe performance. Follow the instructions for maintenance and changing accessories. Keep handle and switches dry, clean and free from oil and grease.
- **Keep air intakes of appliance clean.** Properly wipe off the outside of the tool using a cloth dampened in soapy water. Never use gasoline, thinner or the like, or discoloration and/or crack can take place.
- **Store idle power tools out of the reach of children and do not allow persons unfamiliar with the power tool or these instructions to operate the power tool.** Power tools are dangerous in the hands of untrained users.
- **Store the appliance with battery pack fully charged.**

SAFETY INFORMATION

Please read these instructions fully before operating or maintaining your machine

- **Always wait until the machine has come to a complete stop before placing it down.** The tool insert can jam and lead to loss of control over the power tool.
- **Lock the On/Off switch in the off position, before any work on the machine (e. g. maintenance, changing the tool, etc.) as well as during its transport and storage, lock the On/Off switch in the off position.** There is danger of injury when the On/Off switch is unintentionally actuated.
- **Protect the power tool against heat,, e. g., against continuous intense sunlight, fire, water, and moisture.** Danger of explosion.
- Wear a dust mask when using the tool.

SAFETY WARNING FOR BATTERY

- **Never attempt to open or modify battery for any reason.** Released electrolyte is corrosive and may cause damage to eyes and skin. It may be toxic if swallowed.
- **Under extreme conditions, battery leakage may occur.** When you notice liquid on the battery, proceed as follows:
 - Carefully wipe the liquid off using a cloth. Avoid skin contact.
 - **The battery fluid, a 25-30% solution of potassium hydroxide, can be harmful. In case of skin contact, immediately rinse with water.** Neutralize with a mild acid such as lemon juice or vinegar. In case of eye contact, rinse abundantly with

clean water for at least 10 minutes.

- **Do not expose to water.**
- **Charge at room temperature: 18°C-24°C, never at ambient temperatures below 5°C and above 45°C.**
- **Charge only using the designated charger provided with the tool.**
- **Before charging, make sure that the battery is dry and clean.**
- **Use only the correct type of battery for the tool.**
- **Exercise care in handling and storing batteries in order not to short them with conductive materials such as rings, keys, coins.** There is a real risk of the battery or the conductor overheating, causing fire or burns.
- **Do not dispose of battery in fire.** It may explode. Follow instructions and regulations given by local authorities concerning environmental protection. Dispose of old batteries at an appropriate waste disposal facility.

SAFETY WARNING FOR CHARGERS

- **Use your charger only to charge the battery in the tool which it was supplied.** Other batteries could burst, causing personal injury and damage.
- **Never attempt to charge non-rechargeable batteries.**
- **Do not expose the charger to water.**

SAFETY INFORMATION

Please read these instructions fully before operating or maintaining your machine

- Do not open the charger.
- Do not probe the charger.

VIBRATION AND NOISE REDUCTION

To reduce the impact of noise and vibration emission, limit the time of operation, use low-vibration and low-noise operating modes as well as wear personal protective equipment.

Take the following points into account to minimize the vibration and noise exposure risks:

- Only use the product as intended by its design and these instructions.
- Ensure that the product is in good condition and well maintained.
- Use correct application tools for the product and ensure they in good condition.
- Keep tight grip on the handles/gripping surface.
- Maintain this product in accordance with these instructions and keep it well lubricated (where appropriate).
- Plan your work schedule to spread any high vibration tool use across a longer period of time.

RESIDUAL RISKS

Even if you are operating this product in accordance with all the safety requirements, potential risks of injury and damage remain. The following dangers can arise in connection with the structure and design of this product:

- Health defects resulting from vibration emission if the product is being used over long periods of time or not adequately managed and properly maintained.
- Injuries and damage to property due to broken application tools or the sudden impact of hidden objects during use.
- Danger of injury and property damage caused by flying objects.



WARNING!

This product produces an electromagnetic field during operation!

This field may under some circumstances interfere with active or passive medical implants! To reduce the risk of serious or fatal injury, we recommend persons with medical implants to consult their doctor and the medical implant manufacturer before operating this product!

SAFETY INFORMATION

Please read these instructions fully before operating or maintaining your machine

INTENDED USE

This reciprocating garden saw - with fixed stops is intended for cutting wood, plastic and building materials. The tool is suitable for rough saw cuts, straight or curved cuts, and flush surface cuts. Used with the holding bracket, the tool is suitable for cutting branches. Please note the information on the saw blades and the instructions on sawing. Any other use or modification of the tool is deemed improper use with serious risks. The manufacturer is not liable for damage caused by improper use. The tool is not intended for commercial use.

BOX CONTENT

PARTS

- | | |
|----------------------------|------------------------|
| 1 Blade(3pcs) | 6 LED charge indicator |
| 2 A-clamp | 7 ON/OFF Switch |
| 3 Front guard | 8 Dual safety switch |
| 4 Quick-action blade clamp | 9 Battery pack |
| 5 A-clamp release button | 10 Charger |

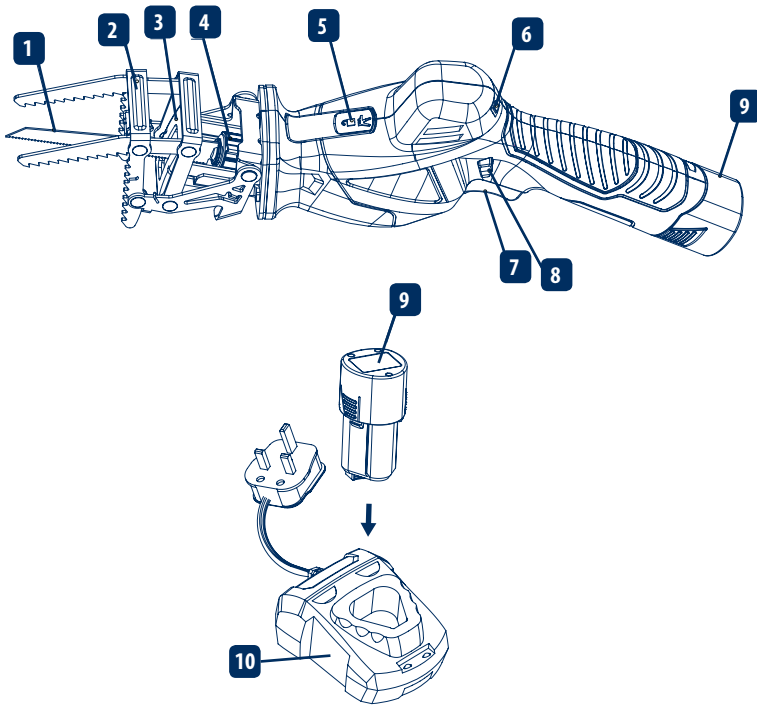

If there are any parts missing, please call the customer helpline on 01904 727505

ASSEMBLY

1 Removing / charging / inserting the battery pack

NOTE: The battery is partly charged at the time of delivery. Charge the battery before use. Li-Ion batteries can be charged at any time without reducing the life. Interrupting the charging process does not damage the rechargeable battery.

- To remove the battery pack press the release buttons and slide the battery pack out of the tool.
- Insert the rechargeable battery pack into the rapid charger.
- Insert the mains plug into the mains socket. The status LED will light up red.
- The green status LED shows charging is completed and the battery pack is ready for use.
- Slide the battery pack into the tool.

2 Checking the battery charge

Press the test button to check the battery condition.

The battery LED indicates the condition and the remaining charge as follows:

RED / ORANGE / GREEN = maximum charge/power

RED / ORANGE = medium charge/power

RED = low charge /recharge battery

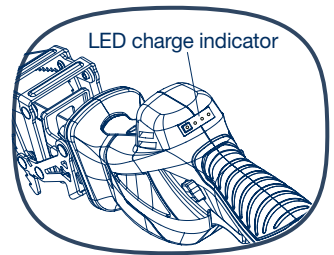

3 Install the A-clamp

NOTE: Always wear safety gloves when installing or changing the saw blade. Make sure the blade is not attached.

Press the A-clamp release button (5), then slide the A-clamp over the front guard and align the locating slot to the housing.

Push the A-clamp in place. Release the A-clamp release button to lock the A-clamp. Make sure the A-clamp is secure.

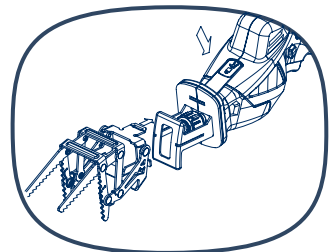

ASSEMBLY

4 Install the blade

- Turn the quick-action blade clamp in anti-clockwise and then insert the saw blade. Align the locating slot to the end. Release the quick-action blade and it will auto rotate in clockwise to lock the saw blade. Ensure the blade is secured tight.

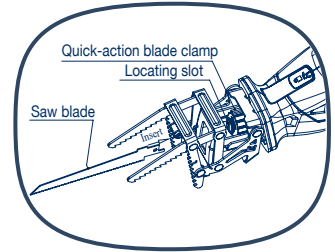

NOTE: there are 3 blades for different tasks.

Top for wood.



Flexible for metal.



Flexible for wood and metal.



5 Replace the blade

- Turn the quick action blade clamp in anti-clockwise, and then remove the saw blade from the locating slot.
- Release the quick action blade clamp and it will auto rotate in clockwise.

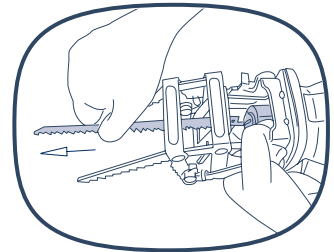

ASSEMBLY

6 Remove the A-clamp

NOTE: The A-clamp cannot be installed or removed with the saw blade installed.

Press the A-clamp release button with one hand, and remove the A-clamp with the other. Release the A clamp release button.

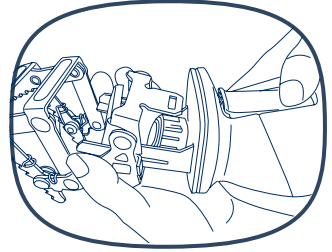

PREPARATION

Charge the battery

NOTE: The battery is partly charged at the time of delivery. Charge the battery before use.

Li-Ion batteries can be charged at any time without reducing the life. Interrupting the charging process does not damage the battery life.

- To remove the battery pack press the release buttons and slide the battery pack out of the tool.

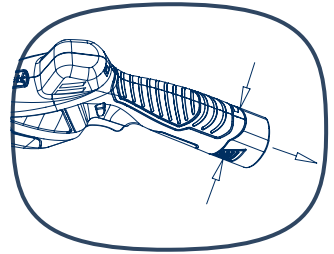

- Insert the rechargeable battery pack into the rapid charger.

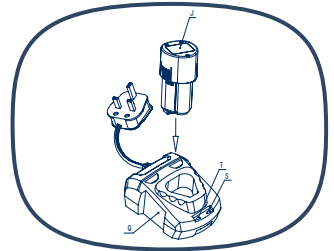

- Insert the mains plug into the mains socket. The red status LED will light up.
- The green status LED flashes during charging, and will stop flashing when the charge is completed.

- Slide the battery pack into the tool.

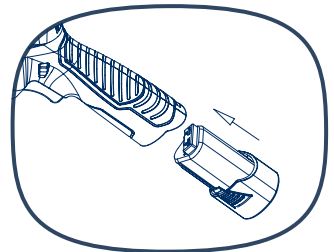

PREPARATION

Checking the battery's charge

When the red, amber and green lights are on, the battery is fully charged. When only the red and amber lights are on, the charge is approximately 60%. If only the red light is on the battery is low and requires charging.

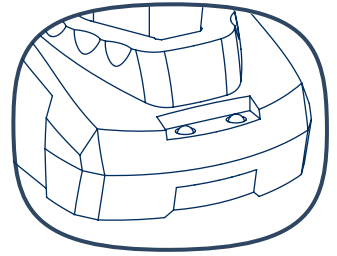

OPERATION

Note: Cut only materials mentioned under intended use and for tasks explained in the manual.

1 Switch on/off

When ready to make a cut, press the dual safety switch button (8) and simultaneously the ON/OFF trigger (7). This will turn the garden saw on.

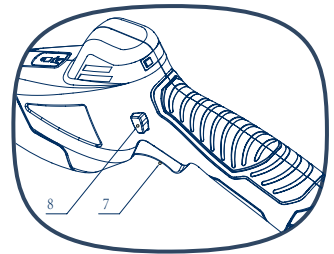

2 Sawing techniques

1. Working without A-clamp

When cutting thicker branches or sawing wood, plastic or metal, work **WITHOUT** A-clamp, the piece to be sawed must touch the front guard. Use a rocking motion when cutting round pieces.

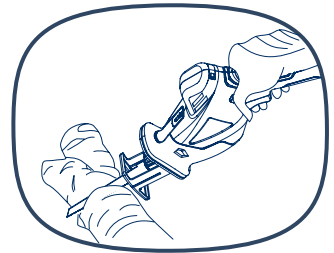

2. Flush cuts

When using flexible saw blades with the respective length you can cut protruding pieces, e.g. pipes, flush with the wall.

- Place the saw blade directly against the wall.
- Apply sideways pressure to the garden saw, bending it so the foot plate (7) touches the wall.
- Switch on the tool and saw through the workpiece, applying consistent pressure.

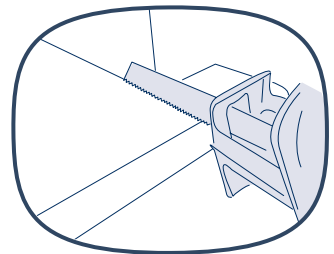

OPERATION

3 Plunge sawing



CAUTION! RISK OF KICK-BACK! Only plunge the saw into a soft work piece (wood, etc.).

- Place the bottom edge of the front guard onto the work piece.
- Switch on the tool.
- Tip the garden saw forward and plunge the saw blade into the work piece.
- Straighten the garden saw into a vertical position and continue cutting along the cutting line.

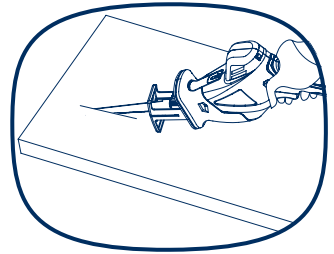

4 Working with the A-clamp

Fit the branch between the A-clamp, and apply a downward pressure to the branch.

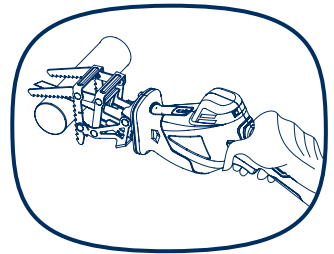



WARNING! Always switch the product off, disconnect the battery pack and let the product cool down before performing inspection, maintenance and cleaning work!

Always remove the blade before working on the machine.

General cleaning

- Clean the tool after finishing work.
- Regular and proper cleaning will help ensure safe use and prolong the life of the product.
- Clean the product with a damp cloth and pH-neutral soap. Use a brush for areas that are hard to reach.
- Inspect the product before each use for worn and damaged parts. Do not operate it if you find broken and worn parts.
- Always keep the tool and the ventilation louvres clean, with a cloth and brush. Clogged ventilation louvres may result in the tool overheating and/or being damaged.
- Do not allow liquids to enter the tool. Never use petrol, solvents or cleaning agents that attack plastic. Remove stubborn dirt with high pressure air (max. 3 bar)
- Clean the saw blade holder, if necessary using a brush or with compressed air.
- When storing a lithium-ion battery for extended periods, regularly check the charge. The optimal charge is between 50% and 80%. The optimal storage climate is cool and dry.

Repair

This product does not contain any parts that can be repaired by the consumer. Contact the after sales support via 01904 727505 if you have any queries.

Storage

- Clean the product as described above.
 - Disconnect the battery pack from the product.
 - Store the product and its accessories in a dry, frost-free place.
 - Always store the product in a place that is inaccessible to children. The ideal storage temperature is between 10 - 30°C.
 - We recommend using the original box for storage or covering the product with a suitable cloth or enclosure to protect it against dust.
-

Transportation

- Switch the product off and disconnect the battery pack from the product.
- Always carry the product by its handles/gripping surfaces.
- Protect the product from any heavy impact or strong vibration which may occur during transportation in vehicles.
- Secure the product to prevent it from slipping or falling over.

MAINTENANCE

Recycling and disposal



Li-Ion

- The product comes in a package that protects it against damage during shipping. Keep the packaging until you are sure that all parts have been delivered and the product is functioning properly. Recycle the packaging afterwards.
- Old products are potentially recyclable and do not belong in your household waste. You are requested to assist us and our contribution to saving resources and protecting the environment by handing in this product at an equipped collection centre.

Part number	Accessories
JLH201261500G	Charger
ET-D1081	Battery
BGS108-045	Cutting blades
BGS108-025	A-clamp

TECHNICAL DATA

Model	BGS108
Voltage	DC 10.8V
Stroke rate	0~2500/min
Stroke	20mm
Cutting capacity max without A-clamp	70mm
Cutting capacity max with A-clamp	65mm
Charger model	JLH201261500G
Input rated voltage	100-240V~ /50-60Hz
Input power	30W
Output rated voltage/current	12.6V DC-1.5A
Protection class	II
Charging time	approx. 70mins
Battery pack model	ET-D1081
Type	li-ion
Rated voltage	10.8V DC
Capacity	1.5Ah

Noise and vibration data:

Measured data for noise is determined in accordance with EN60745. The A-rated noise level of the power tool is typically:

Measured sound pressure level:	82.2dB(A)
Measured sound power level:	93.2dB(A)
Uncertainty K:	3dB(A)

Vibration emission values:

Vibration emission value (cutting boards):	9.454m/s ²
Vibration emission value (cutting wooden beams):	6.473m/s ²
Uncertainty K:	1.5 m/s ²

TECHNICAL DATA

The sound values have been determined according to noise test code given in EN 60745-2-11, using the basic standards EN ISO 11203 and EN ISO 3744.

The noise figures quoted are emission levels and are not necessarily safe working levels. Factors that influence the actual level of exposure of work-force include the characteristics of the work room, the other sources of noise, etc. i.e. the number of machines and other adjacent processes, and the length of time for which an operator is exposed to the noise. Also the permissible exposure level can vary from country. This information, however, will enable the user of the machine to make a better evaluation of the hazard and risk.

Wear hearing protection! The sound intensity level for the operator may exceed 80 dB(A) and ear protection measures are necessary!

The declared vibration value has been measured in accordance with a standard test method (according to EN 60745-1) and may be used for comparing one product with another. The declared vibration value may also be used in a preliminary assessment of exposure.

This tool may cause hand-arm vibration syndrome if its use is not adequately managed.



WARNING!

Depending on the actual use of the product the vibration values can differ from the declared total! Adopt proper measures to protect yourself against vibration exposures! Take the whole work process including times the product is running under no load or switched off into consideration!

Proper measures include among others regular maintenance and care of the product and cutting attachments, keeping hands warm, periodical breaks and proper planning of work processes!

TROUBLESHOOTING

Suspected malfunctions are often due to issues that the user can fix themselves. Therefore, check the product using this section. In most cases the problem can be solved quickly.



WARNING! Only perform the steps described within these instructions! All further inspection, maintenance and repair work must be performed by an authorised service centre or a similarly qualified specialist if you cannot solve the problem yourself!

Problem	Solution
1. LED lights do not illuminate on charger.	1.1 Check the charging adaptor is securely plugged into the wall outlet. 1.2 Check the battery is firmly connected to the charging cradle.
2. The battery has a short run time.	Ensure the battery is properly charged. It will take 4-5 charging cycles before the battery reaches optimum charge and run time.
3. Variable speed trigger is locked.	Ensure that the safety switch is pressed left or right to enable the trigger to be pressed.
4. Saw has cut out during use.	The battery may have run out of power and requires charging. If the battery is fully charged, it is likely that the battery's thermal voltage protection has been activated. This can happen when the saw has been used for extended periods. Place the battery on the charger for an hour. It will need this time to cool down and for the protection circuits to be reset.
5. Sparking visible through the housing air vents.	A small amount of sparking may be visible through the housing vents. This is normal and does not indicate a problem.

WARRANTY

If your device develops a fault, please don't hesitate to contact our customer service department on **01904 727505**, we can solve the majority of questions via the phone.

1. These warranty terms cover additional warranty rights and do not affect your statutory warranty rights. All our products are covered by a one year manufacturer warranty unless this product was registered within 28 days of purchase via www.spearandjackson-power.com and therefore obtained an additional 12 month warranty.
2. Claims must be accompanied by Proof of Purchase. This must be in the form of a Sales receipt or Bank statement and must show that the product has been purchased within the warranty period as described under point 1, from the retailer that it was originally bought from. Please keep your receipt safe or staple it to the back of this manual for future reference.
3. Our warranty covers problems caused by material or manufacturing defects, and will result in the repair of these defects or replacement of the device with a like for like, re-conditioned or upgraded like for like or similar article.
4. Our devices have not been designed for commercial, trade or industrial applications, any signs of use of the equipment in these application or equivalent activities, invalidates the warranty.
5. The following are also excluded from our warranty:
 - A. Faults due to accidents, customer misuse or unauthorized repairs
 - B. Consumable Parts such as collection bags, knobs, and shoulder straps, and other accessories that are compatible with the product.
 - C. Failure due to lack of routine maintenance.
 - D. Failure as a result of not using the equipment in accordance with the manual and safety instructions
 - E. The adjustment of cables, drives belts or recoil starters.

Warranty claims should be submitted before the end of the warranty period, see point 1, but a paid service exists for repairs commissioned after this period. The original warranty period remains applicable to the device even if repairs are carried out or parts are replaced. In such cases, the work performed or parts fitted will not result in an extension of the warranty period, and no new warranty will become active for the work performed or parts fitted.

If you have any problems or questions concerning your garden power tool, please contact our after sales service at **01904 727505** or visit www.spearandjackson-power.com.

SUMEC

EC DECLARATION OF CONFORMITY

We,

SUMEC UK Co.,Ltd.

Unit A&B, Escrick Business Park

Escrick, York YO 19 6FD

And our branch office

MEROTEC GmbH, Willich, Amtsgericht Krefeld, HRB 14908, Germany

Declare that the product

10.8 V garden saw

Model No: BGS108

Cert No.: GDGS12

Function: Cutting WOOD

Serial number : 00001~00500

Complies with the following directives:

EMC Directive: 2014/30/EU

Machinery Directive: 2006/42/EC

RoHS Directive: 2011/65/EU

Standards conform to:

EN60745-1:2009+A11

EN 60745-2-11:2010

EN55014-1:2006+A1+A2

EN 55014-2:1997+A1+A2

EN 61000-3-2:2014

EN 61000-3-3:2013

Authorized Signatory

Date: 2016-05-17

Signature: 

Name: Roland Menken

General Manager

MEROTEC GmbH.

