

1800W

High Pressure Washer

6796631



V1: 12/24

CAUTION Read the instructions before
using the machine

These instructions contain important information that will help you get the best from your pressure washer, ensuring it is assembled correctly and safely. If you need help or have damaged or missing parts, call the Customer Helpline on 0345 605 2067

AFTER SALES SUPPORT
0345 605 2067

SAN NO.: 0321802039ZL

SPEAR & JACKSON SINCE 1760

For more than 250 years gardeners have enjoyed high quality performance and great results using Spear & Jackson tools.

Our garden power tools combine continuous innovation and the latest in manufacturing technologies with a proud heritage.

Each product is carefully designed with performance, comfort and durability firmly in mind, which has earned Spear & Jackson an enviable reputation as a maker of tools to trust.

3 YEAR GUARANTEE

As a testament to the quality of our products, we offer a 3 year manufacturers warranty and a comprehensive after sales service.

The warranty covers manufacturing faults, however in the event that the item has been deliberately damaged, used in a commercial environment or disassembled then the warranty will be null and void.

Please retain proof of purchase.

7 DAYS A WEEK TECHNICAL SUPPORT

We want you to get the best out of our products. Our easy-to-read instruction manual guides you with best practice use and maintenance tips. Please call **0345 605 2067** for technical support, we can solve around 80% of questions directly over the phone.

We hope you enjoy your product and we look forward to any feedback, as this allows us to develop even better products for the future.

Produced in China for Argos Limited, London, EC1N 2HT, UK. [Argos \(N.I.\) Ltd](#), Forestside Shopping Centre, Upper Galwally, Belfast, BT8 6FX, UK.
<https://bit.ly/Coreservice-Spear-Jackson>

CONTENTS

Safety Information	03
Description of symbols	03
Intended use	04
General safety	05
Additional safety warnings	08
Service	10
Vibration and noise reduction	10
Residual risks	11
General safety warnings for battery	11
Box Contents / Parts	14
Assembly	15
Assembling cord storage, hose storage spray gun holder and extension lance storage	15
Connecting the hose and spray gun	15
Install the batteries into the power control gun	16
Fit the lance and nozzle to power control gun	17
Connecting the hose and pressure washer.....	17
Assembling inlet connector.....	17
Preparation	18
Before starting	19
Connect your adjustable power control gun to the high pressure washer(Signal connection)	19
Operation	21
Starting	21
Stopping	21
High pressure working	22
Using with adjustable nozzle	23
Using the turbo nozzle	23
Using the patio cleaner	24
Using the fixed brush	24
Using the detergent bottle	24
Use with water butt or reservoir	25
Maintenance	26
Overview of cleaning	26
Cleaning limescale	26
Disposal	27
Technical Data	28
Troubleshooting	29
Guarantee	30

SAFETY INFORMATION

Please read these instructions fully before operating or maintaining your machine

DESCRIPTION OF SYMBOLS

The following warning symbols appear throughout this manual and indicate the appropriate safety measures you should take when operating and maintaining the pressure washer.



Read and understand all instructions before operating the product, follow all warning and safety instructions



Type and source of the danger: This symbol indicates that damage to the appliance, the environment or other property may occur as a result of non-observance of this warning.



The high pressure jet can be dangerous if not used correctly. The jet must never be directed at people, live electrical equipment or the tool.



This machine must not be directly connected to the potable water mains.



Remove plug from the mains immediately if the cable is damaged or cut.



Read the instruction manual.



Waste of electrical products must not be disposed of with household waste. Please recycle

where facilities exist. Check with your local authorities or retailer for recycling advice.



Guaranteed sound power level (tested according to Directive 2000/14/EC as amended by 2005/88/EC).

IPX5

International protection code (protection degree against dust and water intrusion).



Class II tool – double insulation.



Complies with European standards: This symbol means that this appliance is compliant with the applicable European directives, and a test of compliance with these directives has been performed.



Conforms to relevant UK regulatory requirements.



Wear ear protection.

SAFETY INFORMATION

Please read these instructions fully before operating or maintaining your machine

INTRODUCTION

IMPORTANT ! IN ORDER TO OBTAIN THE UTMOST SATISFACTION FROM THIS PRODUCT UPON SETTING IT UP, USING IT, AND MAINTAINING IT, WE RECOMMEND THAT YOU CAREFULLY READ THIS USER MANUAL BEFORE USING THE PRODUCT. PLEASE PAY ATTENTION TO BASIC WARNINGS RELATING TO SAFETY WITHIN THIS MANUAL, AND KEEP THE MANUAL FOR LATER REFERENCE. FOLLOWING THESE INSTRUCTION ALLOW TO OPTIMIZE THE LIFETIME.

INTENDED USE

High-pressure cleaner is a device that uses water under pressure to clean various surfaces. It has a motor that powers a high-pressure pump, which propels high-pressure water through a special nozzle. It can be used for:

- **Cleaning outdoor surfaces:** cleaning outdoor surfaces of the house, such as walls, decks, patios, driveways, pavements and fences. It can effectively remove dirt, grime, mold, algae, stains and other debris that accumulate on these surfaces over time.
- **Vehicle cleaning:** wash cars, motorbikes, boats, caravans and other vehicles. It can remove dirt, mud, bugs, grease and other contaminants from the surface of vehicles, including rims and
- **Cleaning garden equipment:** cleaning garden tools, lawnmowers, hedge trimmers, bicycles, garden furniture and other garden equipment. It can remove dirt, dust, leaves and other debris that accumulate on these items.
- **Pool surface cleaning:** cleaning swimming pools,

SAFETY INFORMATION

Please read these instructions fully before operating or maintaining your machine

spas and hot tubs. It can remove algae, lime deposits, stains and debris that form on the walls, steps and linings of these facilities.

- It is important to note that the use of a pressure washer requires special care, as the water pressure can damage some sensitive surfaces. It is therefore essential to follow the manufacturer's instructions and take appropriate safety precautions when using a pressure washer.
- This product is intended for outdoor use only, and must not be used inside a building under any circumstances.
- The machine must be operated in accordance with the details provided in these instructions.
- Any use of the machine that deviates from its intended use and is not included in these instructions is considered

unauthorized use and relieves the manufacturer from his or her legal liability.

- Attention! Do not operate the appliance at temperature below 0°C
- After unwrapping the packing, make sure that the product is complete with its accessories (if any). If the product is damaged or has any defect, please do not use it and bring back it to your dealer. If you give this tool to another people, please give him also this instruction manual.

GENERAL SAFETY WARNINGS

Machines shall not be used by children. Children should be supervised to ensure that they do not play with the machine. This machine can be used by people with reduced physical, sensory or mental capabilities or lack of experience and knowledge if they have

SAFETY INFORMATION

Please read these instructions fully before operating or maintaining your machine

been given supervision or instruction concerning use of the machine in a safe way and understand the hazards involved.

WARNING!

Read all safety warnings, instructions, illustrations and specifications provided with this power tool. Failure to follow all instructions listed below may result in electric shock, fire and/or serious injury.

Save all warnings and instructions for future reference.

The term “power tool” in the warnings refers to your mains-operated (corded) power tool or battery-operated (cordless) power tool.

WARNING: This machine has been designed for use with the cleaning agent supplied or recommended by the manufacturer. The

use of other cleaning agents or chemicals may adversely affect the safety of the machine.

WARNING: High pressure jets can be dangerous if subject to misuse. The jet must not be directed at persons, live electrical equipment or the machine itself.

The liquid must not be directed towards equipment containing electrical components, such as the interior of ovens.

WARNING: Do not use the machine within range of persons unless they wear protective clothing.

WARNING: Do not direct the jet against yourself or others in order to clean clothes or foot-

WARNING: Risk of explosion – Do not spray flammable liquids.

WARNING: High pressure cleaners shall not be used by children or untrained personnel.

WARNING: High pressure

SAFETY INFORMATION

Please read these instructions fully before operating or maintaining your machine

hoses, fittings and couplings are important for the safety of the machine. Use only hoses, fittings and couplings recommended by the manufacturer.

WARNING: To ensure machine safety, use only original spare parts from the manufacturer or approved by the manufacturer.

WARNING: Water that has flowed through backflow preventers is considered to be nonpotable.

WARNING: Remove the plug from the socket-outlet during cleaning or maintenance and when replacing parts or converting the machine to another function;

WARNING: Do not use the machine if a supply cord or important parts of the machine are damaged, e.g. safety devices, high pressure hoses, trigger gun.

WARNING: Inadequate extension cords can be dangerous. If an extension cord is used, it shall be

suitable for outdoor use, and the connection has to be kept dry and off the ground. It is recommended that this is accomplished by means of a cord reel which keeps the socket at least 60 mm above the ground.

WARNING: Ensure that any exhaust emissions are not in the vicinity of air intakes.

WARNING: Always switch off the mains disconnecting switch when leaving the machine unattended.

■ The machine may only be connected to the mains drinking water supply if a backflow preventer valve with drain facility is installed in the supply hose. Make sure that the hose is at least $\varnothing 13\text{mm}$ and that it is reinforced.

■ If using detergents with the high pressure, make sure the detergents is recommended by the manufacturer. The use of other detergents or chemicals may compromise

SAFETY INFORMATION

Please read these instructions fully before operating or maintaining your machine

the safety of the appliance. The improper use of detergents can cause severe injuries or toxication. Store detergents away from the reach of children.

ADDITIONAL SAFETY WARNINGS

- Never use the product with inflammable or toxic liquids, or liquids with characteristics incompatible with its proper operation.
- Never use the product outdoors in the rain.
- Never lock the gun trigger in the operating position.
- Check that the product is fitted with its rating label; contact your dealer if it is missing. Products without rating label must not be used, since they cannot be identified and are potentially hazardous.
- Never tamper with or adjust the setting of the safety valve or the safety devices.
- Never change the original diameter of the adjustable nozzle.
- The appliance shall not be left unattended while it is connected to the supply mains.
- Do not allow vehicles to drive over the pressure hose.
- Do not move the product by pulling on the pressure hose.
- When directed towards tyres, tyre valves or other pressurised components, the high pressure jet is potentially dangerous. Do not apply a jet stream and always keep the nozzle at a distance of at least 30 cm during cleaning.
- Protect all electrical conductors against the water jet.
- High pressure may cause parts to rebound: wear

SAFETY INFORMATION

Please read these instructions fully before operating or maintaining your machine

all the protective clothing and equipment needed to ensure the operator's safety.

- Wear appropriate Personnel Protection Equipment (PPE) while operation e.g. safety boots, safety gloves, safety helmets with visors, hearing protection etc.
- Be aware of kick-back: grip the gun firmly when squeezing the trigger.
- Comply with the regulations of the local water supply authority. Under EN 12729 (BA) the product can be connected directly to the mains drinking water supply only if the supply hose is fitted with a backflow preventer device with drainage facility.
- Discharge residual pressure before disconnecting the hose from the product.
- Check before each use, and at regular intervals, that all metal fasteners are tight and the product's components are in good condition; inspect for broken or worn parts.
- The appliance is not to be used if it has been dropped, if there are visible signs of damage or if it is leaking.
- Keep the appliance out of reach of children when it is energized or cooling down.
- The electric supply connection should be made by a qualified electrician and comply with IEC 60364-1. It is recommended that the electric supply to this machine should include either a residual current device that will interrupt the supply if the leakage current to earth exceeds 30 mA for 30 ms or a device that will prove the earth circuit.
- Disconnect from the electrical power supply before carrying out user maintenance.
- Do not use the machine if a supply cord or important

SAFETY INFORMATION

Please read these instructions fully before operating or maintaining your machine

parts of the machine are damaged, e.g. safety devices, high pressure hoses, trigger gun.

- If an extension cable is used, the plug and socket outlet must be of watertight construction.
- If the supply cord is damaged, it must be replaced by the manufacturer or its service agent or a similarly qualified person in order to avoid a hazard.

SERVICE

- Have your power tool serviced by a qualified repair person using only identical replacement parts. This will ensure that the safety of the power tool is maintained.

VIBRATION AND NOISE REDUCTION

To reduce the impact of noise and vibration emission,

limit the operating time, use low- vibration and low-noise operating modes, and wear personal protective equipment. Take the following points into account to minimise the vibration and noise exposure risks:

- Only use the product as intended by its design and these instructions.
- Ensure that the product is in good condition and well maintained.
- Use correct attachments for the product and ensure they are in good condition.
- Keep tight grip on the handles/grip surface.
- Maintain this product in accordance with these instructions and keep it well lubricated (where appropriate).
- Plan your work schedule to spread any high vibration tool use across a longer period of time.

SAFETY INFORMATION

Please read these instructions fully before operating or maintaining your machine

RESIDUAL RISKS

Even if you are operating this product in accordance with all the safety requirements, potential risks of injury and damage remain. The following dangers can arise in connection with the structure and design of this product:

- Health defects resulting from vibration emission if the product is being used over long periods of time or not adequately managed and properly maintained.
- Injuries and damage to property due to broken cutting attachments or the sudden impact of hidden objects during use.
- Danger of injury and property damage caused by flying objects.
- Prolonged use of this product exposes the operator to vibrations and may produce 'whitefinger' disease. In order to reduce

the risk, please wear gloves and keep your hands warm. If any of the 'whitefinger' symptoms appear, seek medical advice immediately. 'Whitefinger' symptoms include: numbness, loss of feeling, tingling, pricking, pain, loss of strength, changes in skin colour or condition. These symptoms normally appear in the fingers, hands or wrists. The risk increases at low temperatures.

WARNING! TO ENSURE MACHINE SAFETY. USE ONLY ORIGINAL SPARE PARTS FROM THE MANUFACTURER OR APPROVED BY THE MANUFACTURER

GENERAL SAFETY WARNINGS FOR BATTERY

- Keep batteries out of the reach of children
- Keep batteries clean and dry.

SAFETY INFORMATION

Please read these instructions fully before operating or maintaining your machine

- Dispose of properly
- Do not subject cells or batteries to mechanical shock.
- Seek medical advice immediately if a battery has been swallowed.
- Do not short-circuit, heat or disassemble the batteries or place them into water or fire. Failure to observe this may cause the batteries to overheat, leak, explode or catch fire, and burns or other injury may result.
- Do not store cells or batteries haphazardly in an area where they may short-circuit each other or be short-circuited by other metal objects. Do not carry individual batteries in your pockets or bag as they could short-circuit against other metal items.
- When inserting the batteries, make sure the polarities (+ and -) are correct. If the batteries are inserted incorrectly, they may explode or leak, and fire, injury or contamination of the battery compartment and surrounding area may result.
- Use only the specified batteries. If incorrect or different kinds of batteries are used, they may explode or leak, and fire, injury or contamination of the battery compartment and surrounding area may result.
- Do not mix old and new batteries. If the batteries are used mixing old and new, they may explode or leak, and fire, injury or contamination of the battery compartment and surrounding area may result.
- Remove the used batteries from the power control gun promptly. If you leave used batteries in the remote control for an extended period of time, it may cause liquid leaking, abnormal internal temperature rising

SAFETY INFORMATION

Please read these instructions fully before operating or maintaining your machine

or explosion.

- In the event of a cell leaking, do not allow the liquid to come in contact with the skin or eyes. If contact has been made, wash the affected area with copious amounts of water and seek medical advice.
- Wipe the cell or battery terminals with a clean dry cloth if they become dirty.
- The storage area should be clean, cool, dry, ventilated and weatherproof. For normal storage, the temperature should be between +10°C and +25°C and never exceed +30°C. Batteries should therefore not be stored next to radiators or boilers, nor in direct sunlight.
- Do not charge batteries. Attempting to charge a non-rechargeable (primary) battery may cause internal gas or heat generation resulting in venting, leakage, explosion and personal injury.

BOX CONTENTS

PARTS

- | | |
|-------------------------------|--|
| 1 High pressure washer | 12 Instruction manual |
| 2 Cord storage | 13 Water inlet connector |
| 3 Telescopic handle | 14 High pressure hose |
| 4 Patio cleaner | 15 Extension lance storage |
| 5 Patio cleaner lance | 16 Spray gun holder |
| 6 Fixed brush | 17 Hose storage |
| 7 Power control gun | 18 Screwdriver (PH0) |
| 8 Extension lance | 19 AAA battery X2 for power control spray gun |
| 9 Adjustable nozzle | 20 ON/OFF switch |
| 10 Turbo nozzle | 21 Water outlet |
| 11 Foam bottle | 22 Outlet hose lock button |

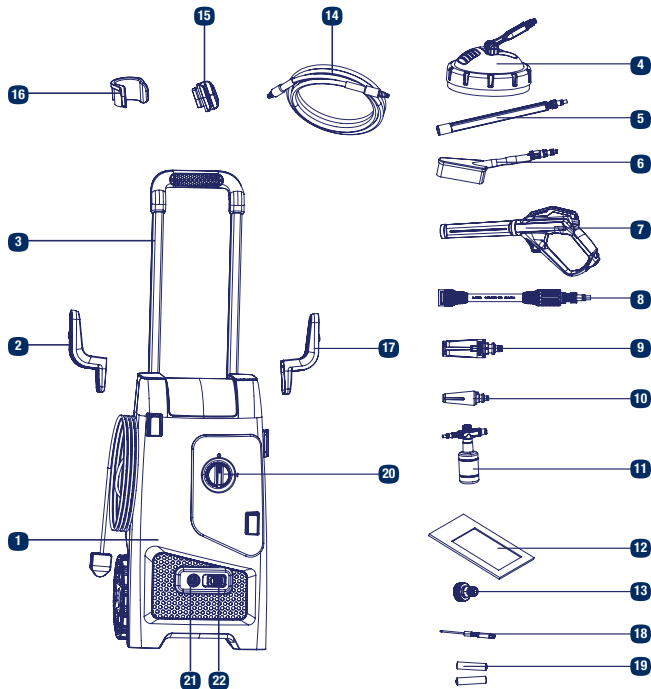

If there are any parts missing, please call the customer helpline on 0345 605 2067

ASSEMBLY



WARNING - Pull out the power plug before carrying out any work on the equipment, and use only original parts.

Before starting any cleaning task, it is important to inspect the area for objects that could create a hazard. Remove any objects from the work area that could be tripped over, such as toys or outdoor furniture. Ensure that all doors and windows are closed tightly.

1 Assembling cord storage, hose storage spray gun holder and extension lance storage.

Slide the cord storage (2) and hose storage (17) on the two sides of the machine.

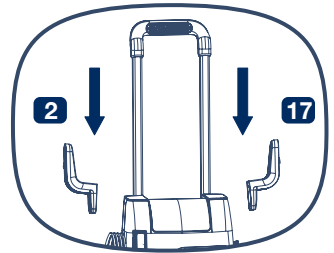

Slide the spray gun holder (16) and extension lance storage (15) onto the front of the machine.

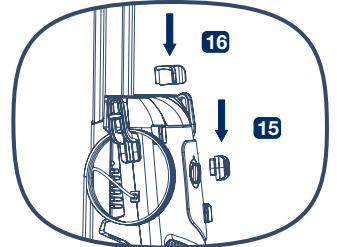

2 Connecting the hose and spray gun.

Connect the high pressure hose (14) firmly onto the adjustable power control gun (7).

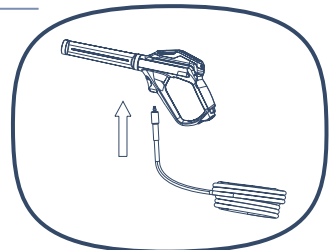

ASSEMBLY

3 Install the batteries into the power control gun.

- i. Open the cover of battery compartment which located in the adjustable spray gun using the screwdriver (18).

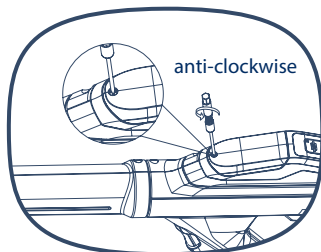

- ii. Install the two AAA batteries (19) in the compartment.

NOTE! When install the batteries, pay attention to the "+" and "-". Make sure the batteries are placed correct polarity.

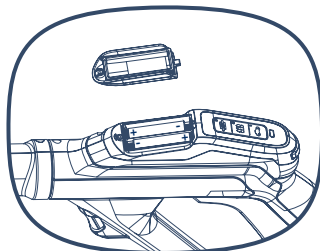

- iii. Clockwise turning screw to close the cover on the top of adjustable spray gun using the screwdriver (18).

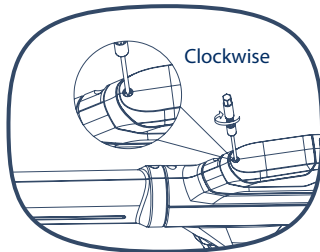

ASSEMBLY

4 Fit the lance and nozzle to power control gun

Insert the adjustable nozzle (9) or turbo nozzle (10) to extension lance (8), align the nozzle notch with the extension lance. A click indicates the nozzle is assembled firmly.

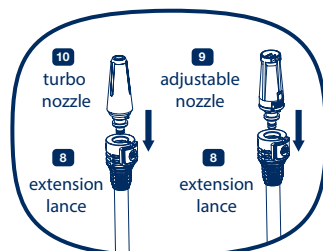

5 Fit the lance and nozzle to power control gun

Insert the adjustable nozzle (9) or turbo nozzle (10) to extension lance (8), align the nozzle notch with the extension lance. A click indicates the nozzle is assembled firmly. then attach the extension pressure washer lance to the adjustable pressure power control gun (7) and twist 1/4 turn to lock in position.

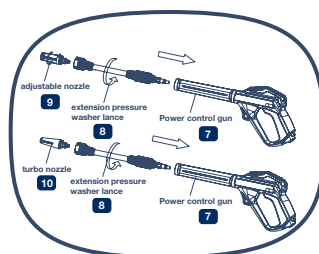

6 Connecting the hose and pressure washer.

Attach high pressure hose (14) to the machine's water outlet (21). A click indicates that the hose is connected well.

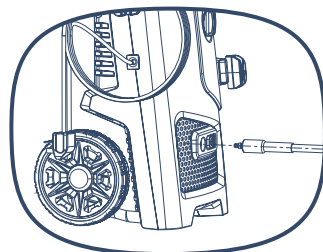

7 Assembling inlet connector

Attach the water inlet connector (13) to the machine's water inlet. Tighten by hand only.

The machine can also operate with water from sources other than a water tap, e. g. ponds and water butts. The use of an additional water filter (not supplied) is highly recommended for this kind of use.

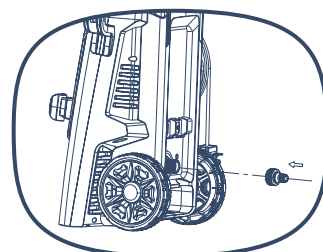

PREPARATION

1 Connecting garden hose to water supply.

Attach garden hose(not included) to the non-potable water supply and turn water on until a steady flow of water runs out of the hose. Turn the water off.

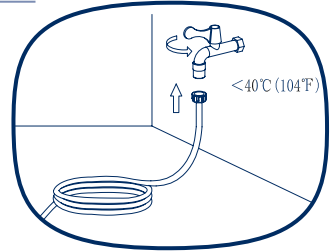

2 Connecting garden hose and inlet connector.

Attach a hose with a quick connect coupling (not included) to the high pressure washer.

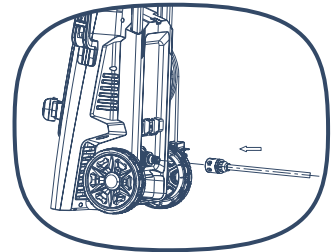

3 OFF position.

Make sure the ON/OFF switch (20) is in the OFF position.

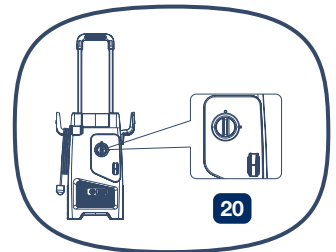

4 Connecting to socket.

Insert the mains plug into the socket.

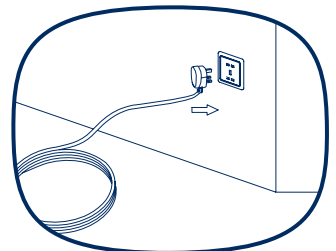

PREPARATION



WARNING - Wear suitable clothing, ear and eye protection when working with the equipment. Ensure that the mains voltage value matches the label on the equipment.

Before starting

- i. Check the machine for visual defects.
- ii. Check that all parts of the machine have been securely fitted.
- iii. Check if the water connector and the high-pressure hose are tight.
- iv. When you start the machine, it will takes a few seconds before water spray come out. It is due to the machine was discharging the gas in it.

Connect your adjustable power control gun to the high pressure washer(Signal connection)

- i. Turn off your pressure washer and turn on it again. Then press the button for five seconds to connect the adjustable power control gun and the pressure washer.

Note: The pressure washer will go with high pressure mode if the signal connection between power control gun and pressure washer is not established.

Note: The signal connection between the adjustable pressure gun and the pressure washer need to be established within 15 seconds after the pressure washer is turned on. If not succeed, the pressure washer needs to be turned off and turned on again to connect with the adjustable pressure gun.

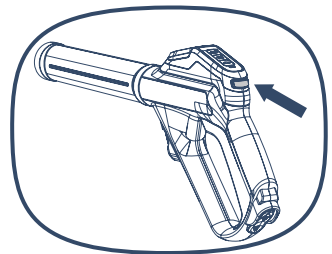



PREPARATION

- i. Three lights on the adjustable pressure gun will flash three times at the same time to remind you of successful connection.

Note: If not succeed, the pressure washer needs to be turned off and turned on again to connect with the adjustable pressure gun.

- ii. Press the button on the adjustable pressure gun could change the water pressure.

 High pressure (Brick cleaning)	Power level 3
 Medium pressure (Fence cleaning)	Power level 2
 Low pressure (Car cleaning)	Power level 1

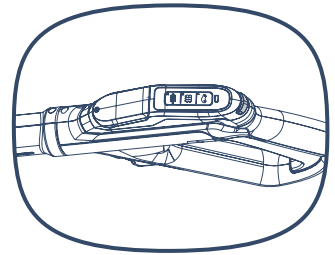

WARNING Please remove the two AAA batteries from the adjustable pressure gun if you do not use it over 1 month.

OPERATION

Starting

- i. Put the high pressure washer on level ground. Stand in a secure and stable position.
- ii. Open the water supply.
- iii. Unlock the safety trigger on the power control. Set the On/Off switch to ON.
- V. Press the trigger until there is a steady stream of water. Further, it will take some time to vent the air from the hose after you press the trigger.

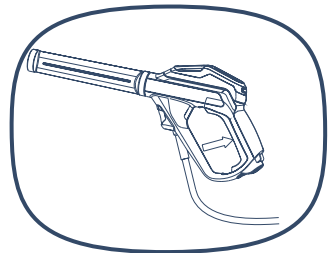
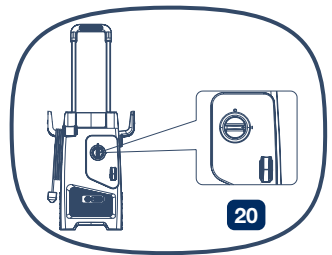
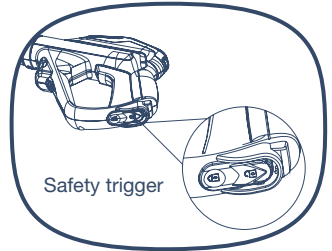

OPERATION

Stopping

- i. Release the trigger, and engage the safety lock.
- ii. Set the ON/OFF switch to OFF.
- iii. Close the water supply.

ATTENTION! Risk of machine damage!

Never operate the machine without the water being connected as dry running may damage the pump. Use a water filter if the inlet water is contaminated.

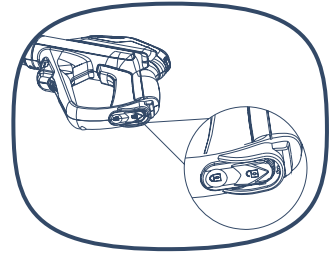

RISK OF FATAL INJURY!

Use special care when cleaning tyres. Vehicle tyres/ tyre valves may become damaged or burst when handled improperly. First signs of damage included discolourations on the tyre. Damaged vehicle tyres/ tyre valves pose a life-threatening risk. Keep the jet at a distance of at least 30 cm!

The high-pressure jet may be dangerous when handled improperly. The jet may not be directed towards living beings (persons, animals), live equipment or the machine itself.

High pressure working

- i. Unlock the safety button and press the trigger on the handheld power control gun.
- ii. Switch on the high pressure washer and hold the hand-held power control gun firmly with both hands.
- iii. The high-pressure pump starts running as soon as you operate the hand-held power control gun.
- iv. The high-pressure pump stops running as soon as you release the trigger on the hand-held power control gun.

Note: Always test the surface in a small and discreet place before cleaning. Pressure washing can strip paint from surfaces and/or leave some surfaces damaged.

OPERATION

Using with adjustable nozzle

Ideal for lighter cleaning tasks like cars, bikes, patios and furniture.

The adjustable nozzle has a 180 degree rotation nozzle to adjust the width of the spray and as such the pressure on the surface.

To adjust the spray, turn the nozzle into the desired direction as shown on the nozzle.

It takes a couple of seconds for the spray to adjust to the new setting.

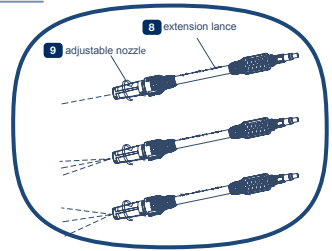

CAUTION! Jet spray adjustment is very aggressive. Do not adjust while spraying. Switch the machine off when interrupting your work for extended periods of time.

Using the turbo nozzle

Ideal for stubborn dirt, painted wood and PVC windows, conservatories and furniture.

The turbo nozzle is designed to have less impact on the surface as the spray rotates around.

Note: Before you clean, always test the impact of the pressure washer on the surface on a non-prominent place.

- i. Stop the machine.
- ii. Change the adjustable spray nozzle with turbo nozzle.
- iii. Test the lance on the surface in non intrusive place.

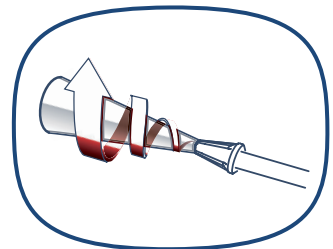
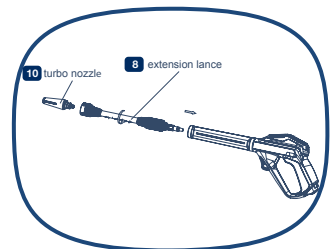

OPERATION

Using the patio cleaner

Ideal for cleaning areas without the splash-back of dirt like patios, fences, garage doors, gravel and pebbled pathways.

Stop the machine before changing the lance for the extension pole and patio cleaner.

Remove the nozzle (Turbo or adjustable nozzle) and extension lance (8). Assemble the patio cleaner lance (5) and patio cleaner (4).

To clean the patio make side ways movements, instead of up and down scrubbing movements.

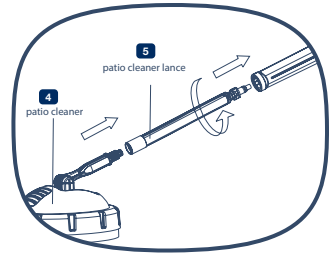

Using the fixed brush

Ideal for cleaning delicate surfaces, like vehicles and paint work, as the fixed brush is a low pressure accessory.

Directly connect the fixed brush (6) with power control gun (7).

Stop the machine before attaching the brush to the power control gun.

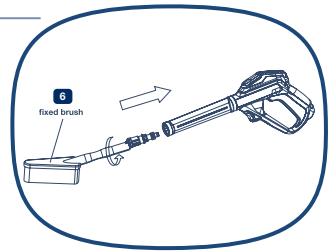

Using the detergent bottle

Special pressure washer detergents can be used to increase the cleaning power of the pressure washer.

- i. Make sure the machine is turned off and engage the safety lock on the power control gun, before filling the detergent bottle.
- ii. Attach the foam bottle directly to the adjustable pressure power control gun.
- iii. Turn on the pressure washer and unlock the power control gun. Then adjust the proper pressure by pressing the button on the adjustable pressure gun. Adjust the spray by adjusting the rotary knob on the foam bottle.

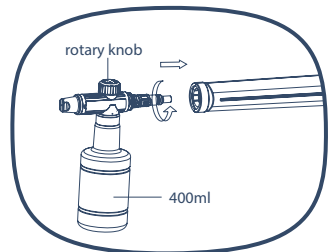

OPERATION

Note:

- Allow detergent to remain on the surface for a short time before rinsing. Do not allow detergent to dry on surface.
 - Before you change the type of detergent for another job, rinse the detergent tank with clean water.
Pull the trigger on the lance at low pressure for one minute until all all detergent is flushed through the system.
-

Use with water butt or reservoir

The machine can also operate with water from sources other than a water tap, e. g. ponds and water butts. The use of an additional water filter (not supplied) is highly recommended for this kind of use.

Make sure the water source is situated no more than 1m below the level of the machine. The water inlet hose must not be too long, approx. 3 m. Fill water supply hose (not supplied) with water before connecting it to the machine.

Running the machine without water (running dry) will damage it. Run machine without lance attached until there is a constant flow of water.

Turn off machine and connect lance.

Note: The internal mesh filter of the machine is not intended for the filtration of large quantities of impurities.

MAINTENANCE

Overview of cleaning

- After every use wipe the machine with a slightly damp cloth. Do not clean the machine using a high-pressure water jet.
- Clean the high-pressure jet nozzle.

The pressure washer is equipped with a water filter in inlet adapter to protect the pump. If the filter is not kept clean, the water flow to the machine will be restricted and the pump may be damaged.

To clean water filter, remove inlet adapter and get the filter out.

- Rinse filter until it is free of debris and blockage.
- Replace the filter and inlet adapter.

Cleaning limescale

Over time water lime scale, water lime scale may build up on your lance outlet, use the nozzle cleaning pin to remove this. The nozzle pin is fitted on the pin storage on the top of the back.

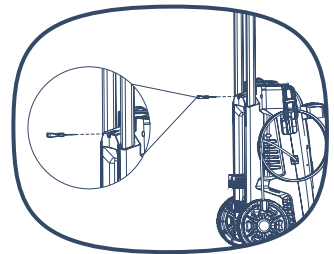
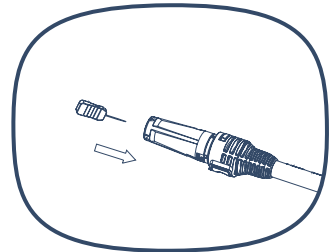
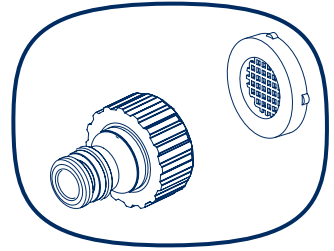

WARNING! Keep the nozzle cleaning pin away from the reach of children. It could cause injury.

MAINTENANCE

Storing

Store the machine where it is dry and well ventilated.

When placing the machine out of service for an extended period of time, remove the cleaning agent and drain all the water left in the hoses.

Transport

If shipping, use the original packaging wherever possible.

Disposal

Disposing of the machine

Machines which are labelled with the this symbol  must not be disposed of in household rubbish. You must dispose of such old electrical and electronic appliances separately.

Please check with your local authority about the possibilities for correct disposal. You will thus help to avoid that damaging into the environment.

Disposing of the packaging

The packaging consists of cardboard and correspondingly marked sheets that can be recycled. Make these materials available for recycling.

TECHNICAL DATA

Model	SCEPW18S
Rated voltage	230-240V~, 50 Hz
Rated power	1800W
Rated pressure	9MPa
Max. pressure	13.5MPa
Max. input water pressure	0.6MPa
Rated flow	5.5l/min
Max. flow rate	7l/min
Protection degree against water	IPX5
Insulation protection class	class II
Inlet Tmax	40°C(104°F)
Measured sound pressure level	77dB(A),K= 3dB(A)
Measured sound power level	88.81dB(A) K=2.09dB(A)
Guaranteed sound power level	93dB(A)
Vibration	<2.5m/s ² , K=1.5m/s ²
Net Weight:	9kg
Fuse in plug	13A
Hose	6m
Cable	5m
Battery	2 x AAA, 1.5V

Part number	Accessories
9260092001	Power control gun
1000666001	Fixed brush
1000707002	Turbo nozzle
2700231001	Adjustable nozzle
0260024001	8" Patio cleaner

TROUBLESHOOTING

Suspected malfunctions are often due to causes that the user can fix themselves. Therefore, check the product using this section. In most cases the problem can be solved quickly.



WARNING - Only perform the steps described within these instructions! All further inspection, maintenance and repair work must be performed by an authorised service centre or a similarly qualified specialist if you cannot solve the problem yourself!

Gloves and appropriate protective clothing must be worn when performing these instructions.

Problem	Possible cause	Solution
1. No Power	<ul style="list-style-type: none">• Check if the plug socket, cable, line and plug are in good condition.• If any of the parts are defective, such as On/Off switch / motor etc.	<ul style="list-style-type: none">• Please contact after sales support at 0345 605 2067.
2.The high pressure washer operates intermittently	<ul style="list-style-type: none">• Internal loose electrical connection.• On/Off switch defective.	<ul style="list-style-type: none">• Contact the after sales support at 0345 605 2067.• Contact the after sales support at 0345 605 2067.
3. No or only little pressure is built up	<ul style="list-style-type: none">• There is air in hose.• Check all inlet pipes leading to the pump for leaks or clogs.	<ul style="list-style-type: none">• Turn off the machine. Run the machine without the high pressure hose connected until water starts flow without bubbles. Reattach the high pressure hose.• Contact the after sales support at 0345 605 2067.
4. Great pressure varieties	<ul style="list-style-type: none">• Check if the nozzle is blocked.• Inlet water is blocked.	<ul style="list-style-type: none">• Clean the high pressure jet nozzle with the nozzle pin provided.• Make sure the inlet hose is not twisted.
5. Machine is leaking	<ul style="list-style-type: none">• Sealing parts are broken.	<ul style="list-style-type: none">• Please contact the after sales support at 0345 605 2067.
6. Pressure cannot be adjusted	<ul style="list-style-type: none">• AAA batteries for power control gun run out.• Connection between pressure washer and power control gun is bad.	<ul style="list-style-type: none">• Install two new AAA batteries in the compartment on power control gun.• Turn off the pressure washer and turn on it again. Press the button on the power control gun and reconnect them.

GUARANTEE

If your device develops a fault, please don't hesitate to contact our customer service department on 0345 605 2067, the majority of issues can be solved directly over the phone.

1. These warranty terms cover additional warranty rights and do not affect your statutory warranty rights. All our products are covered by a 3 year manufacturer warranty
2. Claims must be accompanied by Proof of Purchase. This must be in the form of a sales receipt or Bank statement and must show that the product has been purchased within the warranty period as described under point 1, from the retailer that it was originally bought from. Please keep your receipt safe or staple it to the back of this manual for future reference.
3. Our warranty covers problems caused by material or manufacturing defects, and will result in the repair of these defects or replacement of the device with a like for like or similar article.
4. Our devices have not been designed for commercial, trade or industrial applications, any signs of use of the equipment in these application or equivalent activities, invalidates the warranty.
5. The following are also excluded from our warranty:
 - A. Faults due to accidents, customer misuse or unauthorised repairs
 - B. Consumable parts such as detergent bottle, patio cleaner, extension lance, fixed brush and nozzle pin, and other accessories that are compatible with the product.
 - C. Failure due to lack of routine maintenance.
 - D. Failure as a result of not using the equipment in accordance with the manual and safety instructions
 - E. The adjustment of cables, pumps, or lances.

Warranty claims should be submitted before the end of the warranty period, see point 1, but a paid service exists for repairs commissioned after this period. The original warranty period remains applicable to the device even if repairs are carried out or parts are replaced.

In such cases, the work performed or parts fitted will not result in an extension of the warranty period, and no new warranty will become active for the work performed or parts fitted.

5. Please keep your sales receipt in a safe place. If it is covered by our guarantee your device will either be repaired under the terms of guarantee or we will send you a replacement device.

This device may be re-conditioned, like for like or upgraded replacement.

If you have any problems or questions concerning your garden power tool, please contact our after sales service at 0345 605 2067.