



**SPEAR &
JACKSON**

ORIGINAL INSTRUCTION MANUAL

550W

Electric Pole Hedge Trimmer

S550EHP



**Important - Please read these instructions
fully before starting assembly**

These instructions contain important information that will help you get the best from your trimmer, ensuring it is assembled correctly and safely. If you need help or have damaged or missing parts, call the Customer Helpline on 0345 605 2067

**AFTER SALES SUPPORT
0345 605 2067**

SAN NO.: 0321/8015/02ZA

SPEAR & JACKSON SINCE 1760

For more than 250 years gardeners have enjoyed high quality performance and great results using Spear & Jackson tools.

Our garden power tools combine continuous innovation and the latest in manufacturing technologies with a proud heritage.

Each product is carefully designed with performance, comfort and durability firmly in mind, which has earned Spear & Jackson an enviable reputation as a maker of tools to trust.

3 YEAR GUARANTEE

As a testament to the quality of our products, we offer a 3 year manufacturers warranty and a comprehensive after sales service.

The warranty covers manufacturing faults, however in the event that the item has been deliberately damaged, used in a commercial environment or disassembled then the warranty will be null and void.

Please retain proof of purchase.

7 DAYS A WEEK TECHNICAL SUPPORT

We want you to get the best out of our products. Our easy-to-read instruction manual guides you with best practice use and maintenance tips. Please call **0345 605 2067** for technical support, we can solve around 80% of questions directly over the phone.

We hope you enjoy your product and we look forward to any feedback, as this allows us to develop even better products in the future.

CONTENTS

Safety Information	04
Description of symbols	04
General safety	05
Pole hedge trimmer safety	09
Maintenance and storage safety	10
Intended use	11
In The Box	13
Assembly	14
Unpacking	14
Assembly the pole hedge trimmer	15
Operation	17
General Operation	17
Switching on/off	17
Operation for the pole hedge trimmer	18
Trimming times	19
Trimming	19
Maintenance	21
General cleaning	21
Cleaning the blades	22
Repair	22
Storage	23
Transportation	23
Recycling and disposal	23
Technical Data	24
Troubleshooting	25
Warranty	26

SAFETY INFORMATION

Please read these instructions fully before operating or maintaining your machine

DESCRIPTION OF SYMBOLS

The following warning symbols appear throughout this manual and indicate the appropriate safety measures you should take when operating and maintaining the hedge trimmer.



IMPORTANT!

Read the instruction manual completely and carefully before using the product.



WARNING!

This is a warning symbol. This symbol is used throughout the user manual whenever there is a risk of personal injury. Ensure that these warnings are read and understood at all times.



This power tool is a tool of protection class II. That means it is equipped with enhanced or double insulation.



Conforms to all relevant safety standards.



Remove plug from the mains immediately if cable is damaged or cut.



Do not expose to rain



Wear personal protective equipment. Always wear safety glasses or a face shield, hearing protection and safety helmet.



Caution: Can be very dangerous due to the chance of electric shock. Keep it at least 10m away from transmission lines.



Sharp blade can cut limbs.



Wear gloves for cutting protection.



Wear safety shoes for preventing slipping.



Wear protective clothing



The sound power level indicates by LWA in 101 dB.



Keep all bystanders at least 50 ft.(15m) away.



Keep bystanders away. Potential flying/ or thrown objects can cause serious injury.



This marking indicates that this product should not be disposed of with other household waste. Follow the disposal instructions within this instruction manual.

SAFETY INFORMATION

Please read these instructions fully before operating or maintaining your machine

GENERAL SAFETY



WARNING!

- When using the product the safety rules must be followed. For your own safety and that of bystanders please read these instructions before operating the product.
- Please keep the instructions safe for later use.
- The term “power tool” in the warnings refers to your mains-operated (corded) power tool or battery-operated (cordless) power tool.

Work area safety

- Keep work area clean and well lit. Cluttered or dark areas invite accidents.
- Do not operate power tools in explosive atmospheres, such as in the presence of flammable liquids, gases or dust.

Power tools create sparks which may ignite the dust or fumes.

- Keep children and bystanders away while operating a power tool. Distractions can cause you to lose control.

Electrical safety

- Power tool plugs must match the outlet. Never modify the plug in any way. Do not use any adapter plugs with earthed (grounded) power tools. Unmodified plugs and matching outlets will reduce the risk of electric shocks.
- Avoid body contact with earthed or grounded surfaces, such as pipes, radiators, ranges and refrigerators. There is an increased risk of electric shocks if your body is earthed or grounded.
- Do not expose power tools

SAFETY INFORMATION

Please read these instructions fully before operating or maintaining your machine

to rain or wet conditions. Water entering a power tool will increase the risk of electric shocks.

- Do not abuse the cord. Never use the cord for carrying, pulling or unplugging the power tool. Keep cord away from heat, oil, sharp edges or moving parts. Damaged or entangled cords increase the risk of electric shocks.
- When operating a power tool outdoors, use an extension cord suitable for outdoor use. Use of a cord suitable for outdoor use reduces the risk of electric shock.
- Only use a weather proof extension cable fitted with a coupler according to IEC60320-2-3. Do not use extension cords lighter than:
 - a) if rubber insulated, ordinary tough rubber sheathed flexible cord (code designation 60245 IEC53; H05RN-F);

b) if polyvinyl chloride insulated, ordinary polyvinyl chloride sheathed flexible cord (code designation 60227 IEC53; H05 VV-F).

- Before using, check the supply and extension cord for signs of damage and aging. Do not use the appliance if the cord is damaged or worn.
- If operating a power tool in a damp location is unavoidable, use a residual current device (RCD) protected supply. Use of an RCD reduces the risk of electric shocks.
NOTE: The term “residual current device(RCD)” may be replaced by the term “ground fault circuit interrupter (GFCI)” or “earth leakage circuit breaker(ELCB)”.

Personal safety

- Stay alert, watch what you are doing and use common sense when operating a

SAFETY INFORMATION

Please read these instructions fully before operating or maintaining your machine

power tool. Do not use a power tool while you are tired or under the influence of drugs, alcohol or medication. A moment of inattention while operating power tools may result in serious personal injury.

- Use personal protective equipment. Always wear eye protection. Protective equipment such a dust mask, non-skid safety shoes, hard hat, or hearing protection used for appropriate conditions will reduce personal injuries.
- Prevent unintentional starting. Ensure the switch is in the off-position before connecting to a power source and/or battery pack, picking up or carrying the tool.
- Carrying power tools with your finger on the switch or energising power tools that have the switch on invites accidents.
- Remove any adjusting key or wrench before

turning the power tool on. A wrench or a key left attached to a rotating part of the power tool may result in personal injury.

- Do not overreach. Keep proper footing and balance at all times. This enables better control of the power tool in unexpected situations.
- Dress properly. Do not wear loose clothing or jewelry. Keep your hair, clothing and gloves away from moving parts. Loose clothes, jewelry or long hair can be caught in moving parts.
- If devices are provided for the connection of dust extraction and collection facilities, ensure these are connected and properly used. Use of dust collection can reduce dust-related hazards.

Power tool use and care

- Do not force the power

SAFETY INFORMATION

Please read these instructions fully before operating or maintaining your machine

tool. Use the correct power tool for your application. The correct power tool will do the job better and safer at the rate for which it was designed.

- Do not use the power tool if the switch does not turn it on and off. Any power tool that cannot be controlled with the switch is dangerous and must be repaired.
- Disconnect the plug from the power source and/ or the battery pack from the power tool before making any adjustments, changing accessories, or storing power tools. Such preventive safety measures reduce the risk of starting the power tool accidentally.
- Store idle power tools out of the reach of children and do not allow persons unfamiliar with the power tool or these instructions to operate the power tool. Power tools are dangerous in the hands of untrained users.
- Maintaining power tools. Check for misalignment or binding of moving parts, breakage of parts and any other condition that may affect the power tool's operation. If damaged, have the power tool repaired before use. Many accidents are caused by poorly maintained power tools.
- Keep cutting tools sharp and clean. Properly maintained cutting tools with sharp cutting edges are less likely to bind and are easier to control.
- Use the power tool, accessories and tool bits etc. in accordance with these instructions, taking into account the working conditions and the work to be performed. Use of the power tool for operations different from those intended could result in a hazardous situation.

SAFETY INFORMATION

Please read these instructions fully before operating or maintaining your machine

POLE HEDGE TRIMMER SAFETY WARNINGS

- Keep all parts of the body away from the cutter blade. Do not remove cut material or hold material to be cut when blades are moving. Make sure the switch is off when clearing jammed material. A moment of inattention while operating the hedge trimmer may result in serious personal injury.
- Carry the hedge trimmer by the handle with the cutter blade stopped. When transporting or storing the hedge trimmer always fit the cutting device cover.
- Proper handling of the hedge trimmer will reduce possible personal injury from the cutter blades.
- Hold the power tool by insulated gripping surfaces only, because the cutter blade may contact hidden wiring or its own cord. Cutter blades contacting

a “live” wire may make exposed metal parts of the power tool “live” and could give the operator an electric shock.

- Keep the cable away from your cutting area. During operation the cable may be hidden in shrubs and can be accidentally cut by the blade.



RESIDUAL RISKS

Even when the tool is used as prescribed it is not possible to eliminate all residual risk factors. The following hazards may arise in connection with the tool's construction and design:

1. Damage to lungs if an effective dust mask is not worn.
2. Damage to hearing if effective hearing protection is not worn.
3. Health defects resulting from

SAFETY INFORMATION

Please read these instructions fully before operating or maintaining your machine

vibration emissions if the appliance is being used over a longer period of time or not adequately managed and properly maintained.

WARNING!

This machine produces an electromagnetic field during operation. This field may under some circumstances interfere with active or passive medical implants. To reduce the risk of serious or fatal injury, we recommend persons with medical implants to consult their physician and the medical implant manufacturer before operating this machine.

MAINTENANCE AND STORAGE SAFETY

- Disconnect the product from the power supply (i.e. remove the plug from the power supply or the battery pack)
 - before carrying out maintenance or cleaning work
 - after striking a foreign object. Inspect the tool for damage and make repairs before restarting and operating the tool
- Use only the manufacturer's recommended replacement parts and accessories.
- Inspect and maintain the product regularly. Have the product repaired only by an authorised service centre or similarly qualified specialist.
- When not in use, store the product out of the reach of children.
- Maintaining power tools.
Check for misalignment or binding of moving parts,

SAFETY INFORMATION

Please read these instructions fully before operating or maintaining your machine

breakage of parts and any other condition that may affect the power tool's operation. If damaged, have the power tool repaired before use. Many accidents are caused by poorly maintained power tools.

- Keep cutting tools sharp and clean. Properly maintained cutting tools with sharp cutting edges are less likely to bind and are easier to control.
- Use the power tool, accessories and tool bits in accordance with these instructions, taking into account the working conditions and the work to be performed. Use of the power tool for operations different from those intended could result in a hazardous situation.

Service

- Have your power tools serviced by a qualified repair person using only identical replacement parts.

This will ensure the safe use of the power tool is maintained.

If the supply cord is damaged, it must be replaced by the manufacturer, its service agent or a similarly qualified person in order to avoid a hazard.

INTENDED USE

For pole hedge trimmer

- The device is only determined for cutting and trimming hedges, bushes and shrubs around your house. Any other usage, which is not declared in this manual, can damage the device and cause a serious danger to the user.
- This product is not intended for use by persons (including children) with reduced physical, sensory or mental capabilities, or lack of experience and knowledge, unless they have been given supervision

SAFETY INFORMATION

Please read these instructions fully before operating or maintaining your machine

or instruction concerning use of the product by a person responsible for their safety.

Children should be supervised to ensure that they do not play with the product.

Young people over 16 years old may use the product under supervision only.

The operator or user is responsible for accidents or damage to other people or their properties. The manufacturer is not liable for any damages because of the usage against its original functions or incorrect operation.

IN THE BOX

PARTS

- | | | | |
|---|--|----|----------------------|
| 1 | Cutting blade | 8 | Lock-off button |
| 2 | Blade sheath | 9 | Switch trigger |
| 3 | Cooling air vents | 10 | Main handle |
| 4 | Lock-off button for cutting angle adjustment | 11 | Power cord with plug |
| 5 | Upper shaft | 12 | Cord strain relief |
| 6 | Fixation knob | 13 | Soft grip |
| 7 | Shoulder strap | 14 | Fix knob |

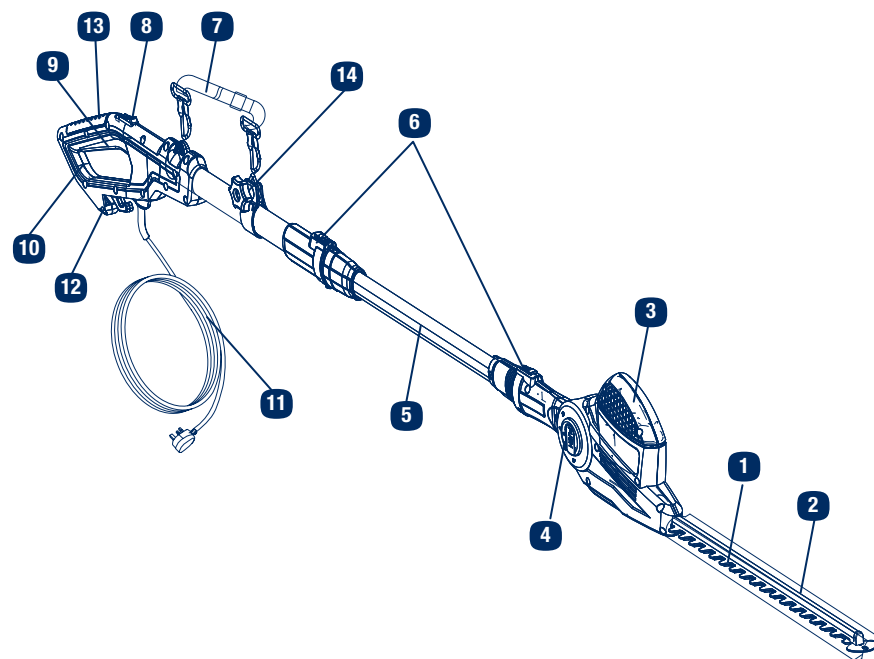

If there are any parts missing, please call the customer helpline on 0345 605 2067

ASSEMBLY

1 Unpacking

- i. Unpack all parts and lay them on a flat, stable surface.
- ii. Make sure all parts and accessories are included and undamaged. If you find that parts are missing or show damage please contact the after sales service at 0345 605 2067. Use of an incomplete or damaged product represents a hazard to people and property.
- iii. Ensure that you have all the accessories and tools needed for assembly and operation. This also includes suitable personal protective equipment (PPE).



WARNING:

If any parts are damaged or missing, do not operate this product until the parts are replaced. Failure to heed this warning could result in serious personal injury.



WARNING:

Do not attempt to modify this product or create accessories not recommended for use with this product. Any such alteration or modification is misuse and could result in a hazardous condition leading to possible serious personal injury.



WARNING:

Do not connect to a power supply until assembly is complete. Failure to comply could result in accidental starting and possible serious personal injury.

ASSEMBLY

2 Assembly the pole hedge trimmer

Before using the pole hedge trimmer, a one-time assembly is required. When removed from the box, the two parts are disconnected as shown in photo below.

- i. Assembly the working head to the telescopic pole handle.

When inserted, the working head (A) would have to target the telescopic pole handle (B), and must be inserted fully. Turn the lock nut (C) to lock, and must be locked fully.

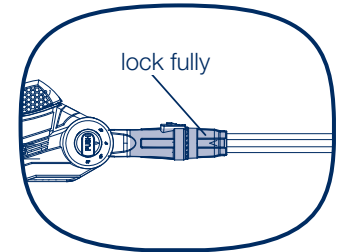
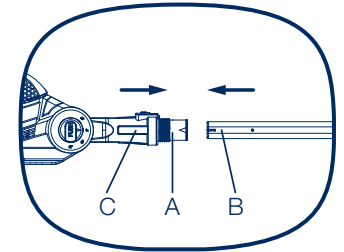

When removing, turn locker (C) to unlock, then pull the handle.

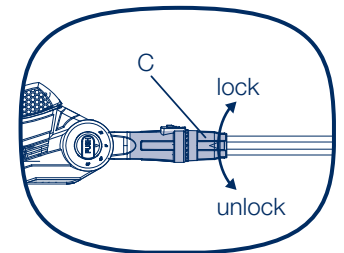

- ii. Attach the shoulder strap

Fix the hook of the shoulder strap into the lifting lug on the handle pole of the appliance.

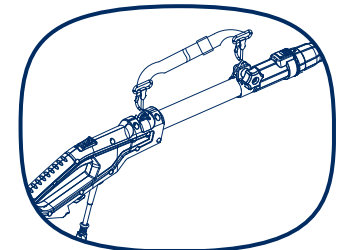

ASSEMBLY

iii. Adjust the telescopic handle

--Push backwards the button(A) then loosen the locker to unlock position ,then adjust the pole to desired pole length.

--Turn locker to the lock position.

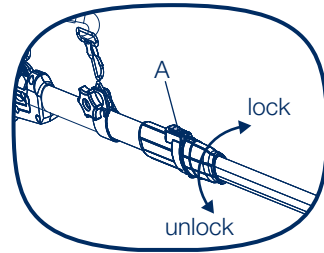

WARNING:

Failure to lock telescopic pole as directed above could result in serious injury or death.

OPERATION

GENERAL OPERATION

- Check the product, its power cord and plug as well as accessories for damage before each use. Do not use the product if it is damaged or shows wear.
- Double check that accessories and cutting device are properly fixed in place.
- Always hold the product by its handles. Keep the handles dry to ensure safe support.
- Ensure that the air vents are always unobstructed and clear. Clean them if necessary with a soft brush. Blocked air vents may lead to overheating and damage of the product.
- Switch the product off immediately if you are disturbed while working by other people entering the working area. Always let the product come to a complete stop before putting it down.
- Do not overwork yourself. Take regular breaks, ensuring full concentration is maintained whilst operating the product, obtaining full control.

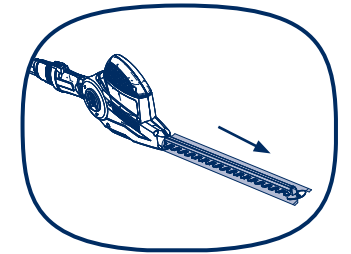

WARNING:

Do not allow familiarity with the product to cause carelessness. One careless second is enough to potentially inflict serious injury.



WARNING:

Always wear safety goggles or safety glasses with side shields when operating power tools. Failure to do so could result in objects being thrown into your eyes, resulting in possible serious injury.



WARNING:

Do not use any attachments or accessories not recommended by the manufacturer of this product. The use of attachments or accessories not recommended can result in serious personal injury.

OPERATION

Switching on/off

Connect the garden tool plug to a power supply.

Attach the outlet end of an extension cord to the plug on the rear of the garden tool. Fix the extension cord through cord retainer.

NOTE: Use only an approved outdoor extension cord as described previously in this manual. Grasp the telescopic pole with your left hand and the rear handle with your right hand.

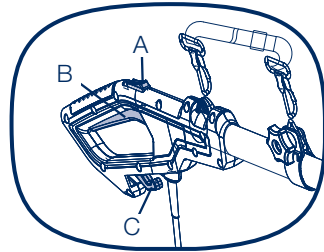

To start the blade movement, push the lock-off button (A) and then pull the switch trigger (B).

To stop blade movement, release the switch trigger off.

NOTE: Adjust hand placement on the telescopic pole of garden tool to keep proper balance. Do not attempt to use the garden tool at a length which does not allow you to achieve proper footing and balance at all times.

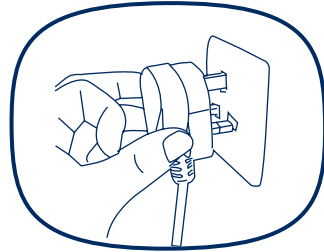

Operation for pole hedge trimmer

Function of swivel head

Disconnect the plug from the power supply.

Place the hedge trimmer on a sturdy flat surface.

Push pivot button and adjust trimmer head until it snaps securely into place at one of the four positions indicated by the notches.

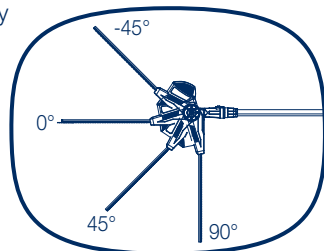
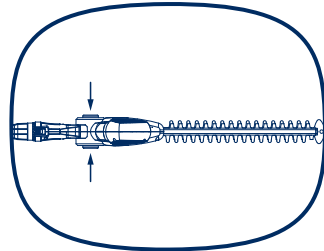

CAUTION:

Do not place hand between pivoting head and threaded base. Failure to heed this caution could result in a pinch point injury.

OPERATION

Trimming times

Green leaf hedges

Evergreens

Conifers and other fast growing shrubs

June to October

April and August

every 6 - 8 weeks

NOTE: Only operate the product during reasonable hours - not early in the morning, late at night or on weekends/public holidays when people might be disturbed. Please check local restrictions.

Trimming



WARNING:

Remove the cut branches. DO NOT exceed the cutting capacity of this product.

With its unique design the pole trimmer can be used to trim and shape hard to reach areas of hedges and bushes such as those shown in below.



WARNING:

Always keep both hands on the hedge trimmer handles. Never hold shrubs with one hand and operate hedge trimmer with the other. Failure to heed this warning can result in serious injury.



WARNING:

Clear the area to be cut before each use. Remove all objects such as cords, lights, wire, or loose string which can become entangled in the cutting blade and create a risk of serious personal injury.



OPERATION

When operating the hedge trimmer, keep the extension cord behind the trimmer. Never drape it over the hedge being trimmed.

Do not force the hedge trimmer through heavy shrubbery. This can cause the blades to bind and slow down. If the blades slow down, reduce the pace.

Do not attempt to cut stems or twigs that are larger than 3/4 of an inch thick, or those obviously too large to feed into the cutting blade. Use a non-powered hand saw or pruning saw to trim large stems.

If blades do become jammed, stop the motor, allow the blades to stop, and disconnect the plug from the power source before attempting to remove the obstruction.

If desired, you can use a string to help cut your hedge level. Decide how high you want the hedge. Stretch a piece of string along the hedge at the desired height. Trim the hedge just above the guide line of string. Trim the side of a hedge so that it will be slightly narrower at the top. More of the hedge will be exposed when shaped this way, and it will be more uniform.

Wear gloves when trimming thorny or prickly growth. When trimming new growth, use a wide sweeping action, so that the stems are fed directly into the cutting blade. Older growth will have thicker stems and will be trimmed easier by using a sawing movement.



WARNING:

Read the safety information for safe operation using the blade. Extreme care must be taken when using blades to ensure safe operation. Refer to Important Safety Instructions and Specific Safety Rules.

Hold unit firmly with both hands. Always keep your left hand on the telescopic pole and your right hand on the rear handle. The unit is used for cutting in either direction in a slow, sweeping action from side to side.

Stand so that you are stable and balanced on both feet. Inspect and clear the area of any hidden objects.

To protect yourself from electrocution, do not operate within 50 feet of overhead electrical lines.

Never use the hedge trimmer near power lines, fencing, posts, buildings, or other immovable objects.

Never use a blade after hitting a hard object without first inspecting it for damage. Do not use if any damage is detected.

MAINTENANCE



WARNING! Always switch the product off, disconnect it from the power supply and let the product cool down before performing inspection, maintenance and cleaning work!



- Regular and proper cleaning will help ensure safe use and will prolong the life of the product.
- Inspect the product before each use for worn or damaged parts. Do not operate it if you find broken or worn parts.
- Lubricate the internal surfaces of the blades with gear grease after each use.

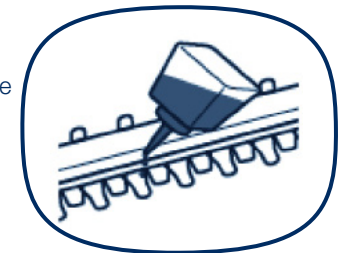

General cleaning

- i. Switch the product off, disconnect it from the power supply and let it cool down.
- ii. Check, clean and store the product as described below.
- iii. Clean the product with a damp cloth and pH-neutral soap. Use a brush for areas that are hard to reach.
- iv. In particular clean the air vents after every use with a cloth and brush.
- v. Remove stubborn dirt with high pressure air (max. 3 bar).

NOTE: Do not use chemical, alkaline, abrasive or other aggressive detergents or disinfectants to clean this product as they might be harmful to its surfaces.

MAINTENANCE

Cleaning the blades



WARNING! When working on/near the blades, ensure safety gloves are worn.

Always use original spare parts when wanting to replace parts.

- i. Keep the blades (1) clean and free of debris. Remove trimmings.
- ii. Apply a small amount of suitable lubricant, like gear grease, on the cutting device (1) to retain a good cutting performance.

Repair

This product does not contain any parts that can be repaired by the consumer. Contact the after sales support if you have any queries.

MAINTENANCE

Storage

- i. Clean the product as described above.
- ii. Attach the blade sheath.
- iii. Store the product and its accessories in a dry, frost-free place.
- iv. Always store the product in a place that is inaccessible to children. The ideal storage temperature is between 10 - 30°C.
- v. We recommend using the original packaging for storage or covering the product with a suitable cloth or enclosure to protect it against dust.

Transportation

- i. Switch the product off and disconnect from the power supply.
- ii. Attach the blade sheath.
- iii. Always carry the product by its handles/gripping surfaces.
- iv. Protect the product from any heavy impact or strong vibration which may occur during the transportation in vehicles.
- v. Secure the product to prevent it from slipping or falling over.

Recycling and disposal

- The product comes in a package that protects it against damage during shipping. Keep the packaging until you are sure that all parts have been delivered and the product is functioning properly. Recycle the packaging afterwards.
- Old products are potentially recyclable and do not, therefore, belong in your household waste. You are requested to assist us and our contribution to saving resources and protecting the environment by handing this product at an equipped collection centre.



TECHNICAL DATA

Model No.:	HHTEG06A(S550EHP)
Rated input voltage	230-240V ~,50Hz
Rated Input Power	550W
Max. cutting length	476mm
Max. cutting capacity	450mm
Safety class	class II
Weight	4.2Kg

Part number	Accessories
HHTEG06A-01	Blade sheath

A-weighted sound pressure level: L_{pA} 84.6dB(A), $K=3$ dB(A)

A-weighted sound power level: L_{WA} 93.94dB(A), $K=3$ dB(A)

Declaration of the noise emission values, according to noise directive

A-weighted sound power level: L_{WA} 101dB(A)

Vibration values:

Front handle vibration a_h : 3.024m/s²,

Rear handle vibration a_h : 2.306m/s²,

Uncertainty K 1.5m/ s²

The sound values have been determined according to noise test code given in a standard (EN 60745), using the basic standards EN ISO 11094 and EN ISO 3744.

The sound intensity level for the operator may exceed 80dB(A) and ear protection measures are necessary.

The declared vibration value has been measured in accordance with a standard (EN 60745) test method and may be used for comparing one product with another. The declared vibration value may also be used in a preliminary assessment of exposure.

WARNING! Depending on the actual use of the product, the vibration values can differ from the declared total! Adopt proper measures to protect yourself against vibration exposures! Take the whole work process including times the product is running under no load or switched off into consideration!

Appropriate measures should be put in place to maintain the care of the product and cutting attachments. To fully ensure safe usage, keep you hands warm when using, take regular breaks if tiredness occurs and ensure proper planning of working processes are understood.

TROUBLESHOOTING

Suspected malfunctions are often due to issues that the user can fix themselves. Therefore, check the product using this section. In most cases the problem can be solved quickly.



WARNING! Only perform the steps described within these instructions! All further inspection, maintenance and repair work must be performed by an authorised service centre or a similarly qualified specialist if you cannot solve the problem yourself!

Problem	Possible cause	Solution
1. Device does not start	<ul style="list-style-type: none"> • Main power is not connected • Cable defective • Switch defective • Carbon brush defective • Motor defective 	<ul style="list-style-type: none"> • Ensure the main power supply is connected • Contact customer service
2. Trimmer does not cut properly	<ul style="list-style-type: none"> • Blade is blunt • Blade is damaged 	<ul style="list-style-type: none"> • Sharpen cutting teeth or place a new blade on • Replace a new blade

WARRANTY

If your device develops a fault, please don't hesitate to contact our customer service department on 0345 605 2067, we can solve 80% of problems via the phone.

1. These warranty terms cover additional warranty rights and do not affect your statutory warranty rights. All our products are covered by a 3 year manufacturer warranty.
2. Claims must be accompanied by proof of purchase. This must be in the form of a sales receipt or bank statement and must show that the product has been purchased within the warranty period as described under point 1. The retailer the product was originally purchased from must also be detailed. Please keep your receipt safe or staple it to the back of this manual for future reference.
3. Our warranty covers problems caused by material or manufacturing defects, and will result in the repair of these defects or the replacement of the device with a like for like or similar article.
4. Our devices have not been designed for commercial, trade or industrial applications, any signs of use of the equipment in these application or equivalent activities, invalidates the warranty.
5. The following are also excluded from our warranty:
 - A. Faults due to accidents, customer misuse or unauthorised repairs.
 - B. Consumable parts such as blade covers, cables, and accessories that are compatible with the product.
 - C. Failure due to lack of routine maintenance.
 - D. Failure as a result of not using the equipment in accordance with the manual and safety instructions.
 - E. The adjustment of cables, drive gears, or blades.

Warranty claims should be submitted before the end of the warranty period (see point 1), but a paid service exists for repairs commissioned after this period. The original warranty period remains applicable to the device even if repairs are carried out or parts are replaced. In such cases, the work performed or parts fitted will not result in an extension of the warranty period, and no new warranty will become active for the work performed or parts fitted.

If you have any problems or questions concerning your garden power tool, please contact our after sales service at 0345 605 2067.