

# POWERBASE

3.6V Cordless  
Mini Hedge Shears 491569

## Instruction Manual

**IMPORTANT!**  
Please read these  
instructions fully before  
starting assembly.



These instructions contain important information that will help you get the best from your product, ensuring it is assembled correctly and safely. If you need help or have damaged or missing parts, call the Customer Helpline on 01904 727 509.

# Contents

General safety warnings	3
Warning symbols	20
In the box	22
Assembly the Mini Shear & Hedge	23
Operating Mini Shear & Hedge	26
Maintenance and storage	29
Troubleshooting	31
Technical data	32
Disposal	33
Getting help	34
Warranty	34

# General Safety Warnings

## Introduction



**IMPORTANT!** In order to obtain the utmost satisfaction from this product upon setting it up, using it, and maintaining it, we recommend that you carefully read this user manual before using the product. Please pay attention to basic warnings relating to safety within this manual, and keep the manual for later reference.

Thank you for choosing our product. Upon designing and manufacturing our products, we place all of our efforts into ensuring an excellent quality that meets the needs of the users.

## Intended use



**IMPORTANT!** The hedge trimmer is designed for cutting and trimming of hedges, bushes and shrubs in domestic gardens.



**IMPORTANT!** The maximum cutting capacity must be observed. Do not cut branches exceeding the stated maximum capacity.



**IMPORTANT!** The appliance is suitable for the private use in the garden only, not for continuous employment in the commercial use.



**IMPORTANT!** This appliance is not intended for use by persons (including children) with reduced physical, sensory or mental capabilities, unless they have been given supervision or instruction concerning the use of the appliance by a person responsible for their safety.

- **Children should be supervised to ensure that they do not play with the product.**

## **General machine safety warnings**



**WARNING!** Read all safety warnings, instructions, illustrations and specifications provided with this machine.

Failure to follow all instructions listed below may result in electric shock, fire and/or serious injury.

**Save all warnings and instructions for future reference.**

The term “machine” in the warnings refers to your mains-operated (corded) machine or battery-operated (cordless) machine.

## Work area safety

- **Keep work area clean and well lit.** Cluttered or dark areas invite accidents.
- **Do not operate machines in explosive atmospheres, such as in the presence of flammable liquids, gases or dust.** Machines create sparks which may ignite the dust or fumes.
- **Keep children and bystanders away while operating a machine.** Distractions can cause you to lose control.

## Electrical safety

- **Machine plugs must match the outlet. Never modify the plug in any way.** Do not use any adapter plugs with earthed (grounded) machines. Unmodified plugs and matching outlets will reduce risk of electric shock.
- **Avoid body contact with earthed or grounded surfaces, such as pipes, radiators, ranges and refrigerators.** There is an increased risk of electric shock if your body is earthed or grounded.

- **Do not expose machines to rain or wet conditions.** Water entering a machine will increase the risk of electric shock.
- **Do not abuse the cord. Never use the cord for carrying, pulling or unplugging the machine. Keep cord away from heat, oil, sharp edges or moving parts.** Damaged or entangled cords increase the risk of electric shock.
- **When operating a machine outdoors, use an extension cord suitable for outdoor use.** Use of a cord suitable for outdoor use reduces the risk of electric shock.
- **If operating a machine in a damp location is unavoidable, use a residual current device (RCD) protected supply.** Use of an RCD reduces the risk of electric shock.

## Personal Safety

- **Stay alert, watch what you are doing and use common sense when operating a machine.** Do not use a machine while you are tired or under the influence of drugs, alcohol or medication. A moment of inattention while operating machines may result in serious personal injury.
- **Use personal protective equipment. Always wear eye protection.** Protective equipment such as a dust mask, non-skid safety shoes, hard hat or hearing protection

used for appropriate conditions will reduce personal injuries.

- **Prevent unintentional starting. Ensure the switch is in the off-position before connecting to power source and/or battery pack, picking up or carrying the tool.** Carrying machines with your finger on the switch or energising machines that have the switch on invites accidents.
- **Remove any adjusting key or wrench before turning the machine on.** A wrench or a key left attached to a rotating part of the machine may result in personal injury.
- **Do not overreach. Keep proper footing and balance at all times.** This enables better control of the machine in unexpected situations.
- **Dress properly. Do not wear loose clothing or jewellery. Keep your hair and clothing away from moving parts.** Loose clothes, jewellery or long hair can be caught in moving parts.
- **If devices are provided for the connection of dust extraction and collection facilities, ensure these are connected and properly used.** Use of dust collection can reduce dust-related hazards.
- **Do not let familiarity gained from frequent use of tools allow you to become complacent and ignore tool safety principles.** A careless action can cause severe injury within a fraction of a second.

## Machine use and care

- **Do not force the machine. Use the correct machine for your application.** The correct machine will do the job better and safer at the rate for which it was designed.
- **Do not use the machine if the switch does not turn it on and off.** Any machine that cannot be controlled with the switch is dangerous and must be repaired.
- **Disconnect the plug from the power source and/ or remove the battery pack, if detachable, from the machine before making any adjustments, changing accessories, or storing machines.** Such preventive safety measures reduce the risk of starting the machine accidentally.
- **Store idle machines out of the reach of children and do not allow persons unfamiliar with the machine or these instructions to operate the machine.** Machines are dangerous in the hands of untrained users.
- **Maintain machines and accessories.** Check for misalignment or binding of moving parts, breakage of parts and any other condition that may affect the machine's operation. If damaged, have the machine repaired before use. Many accidents are caused by poorly maintained machines.

- **Keep cutting tools sharp and clean.** Properly maintained cutting tools with sharp cutting edges are less likely to bind and are easier to control.
- **Use the machine, accessories and tool bits etc. in accordance with these instructions, taking into account the working conditions and the work to be performed.** Use of the machine for operations different from those intended could result in a hazardous situation.
- **Keep handles and grasping surfaces dry, clean and free from oil and grease.** Slippery handles and grasping surfaces do not allow for safe handling and control of the tool in unexpected situations.

## Battery tool use and care

- **Recharge only with the charger specified by the manufacturer.** A charger that is suitable for one type of battery pack may create a risk of fire when used with another battery pack.
- **Use machines only with specifically designated battery packs.** Use of any other battery packs may create a risk of injury and fire.
- When battery pack is not in use, keep it away from other metal objects, like paper clips, coins, keys, nails, screws or other

small metal objects, that can make a connection from one terminal to another. Shorting the battery terminals together may cause burns or a fire.

- **Under abusive conditions, liquid may be ejected from the battery; avoid contact. If contact accidentally occurs, flush with water.** If liquid contacts eyes, additionally seek medical help. Liquid ejected from the battery may cause irritation or burns.
- **Do not use a battery pack or tool that is damaged or modified.** Damaged or modified batteries may exhibit unpredictable behaviour resulting in fire, explosion or risk of injury.
- **Do not expose a battery pack or tool to fire or excessive temperature.** Exposure to fire or temperature above 130 °C may cause explosion.
- **Follow all charging instructions and do not charge the battery pack or tool outside the temperature range specified in the instructions.** Charging improperly or at temperatures outside the specified range may damage the battery and increase the risk of fire.

## Service

- Have your machine serviced by a qualified repair person using only genuine replacement parts. This will ensure that the safety of the machine is maintained.
- Never service damaged battery packs. Service of battery packs should only be performed by the manufacturer or authorized service providers.

## Hedge trimmer safety warnings

- Keep all parts of the body away from the blade. Do not remove cut material or hold material to be cut when blades are moving. Blades continue to move after the switch is turned off. A moment of inattention while operating the hedge trimmer may result in serious personal injury.
- Carry the hedge trimmer by the handle with the blade stopped and taking care not to operate any power switch. Proper carrying of the hedge trimmer will decrease the risk of inadvertent starting and resultant personal injury from the blades.
- When transporting or storing the hedge trimmer, always fit the blade cover. Proper handling of the hedge trimmer will decrease the risk of personal injury from the blades.

- When clearing jammed material or servicing the unit, make sure all power switches are off and the lock-off is in the locked position and the battery pack is removed or disconnected. Unexpected actuation of the hedge trimmer while clearing jammed material or servicing may result in serious personal injury.
- Hold the hedge trimmer by insulated gripping surfaces only, because the blade may contact hidden wiring. Blades contacting a “live” wire may make exposed metal parts of the hedge trimmer “live” and could give the operator an electric shock.
- Keep all power cords and cables away from cutting area. Power cords or cables may be hidden in hedges or bushes and can be accidentally cut by the blade.
- Do not use the hedge trimmer in bad weather conditions, especially when there is a risk of lightning. This decreases the risk of being struck by lightning.

## **Grass shears safety warnings**

- Do not use the grass shear in bad weather conditions, especially when there is a risk of lightning. This decreases the risk of being struck by lightning.
- Keep all power cords and cables away from cutting area. Power cords or cables maybe

hidden and can be accidentally cut by the blade.

- Wear ear protection. Adequate protective equipment will reduce the risk of hearing loss.
- Hold the grass shear by insulated gripping surfaces only, because the blade may contact hidden wiring or its own cord. Blades contacting a “live” wire may make exposed metal parts of the grass shear “live” and could give the operator an electric shock.
- Keep all parts of the body away from the blade. Do not remove cut material or hold material to be cut when blades are moving. Blades continue to move after the switch is turned off. A moment of inattention while operating the grass shear may result in serious personal injury.
- When clearing jammed material or servicing the grass shear, make sure the power switch is off and the battery pack is disconnected. Unexpected actuation of the grass shear while clearing jammed material or servicing may result in serious personal injury.
- Carry the grass shear by the handle with the blade stopped and taking care not to operate the power switch. Proper carrying of the grass shear will decrease the risk of inadvertent starting and resultant personal injury from the blades.

- When transporting or storing the grass shear, always use the blade cover. Proper handling of the grass shear will decrease the risk of personal injury from the blades.
- Adjust the working head only while the cutting device is not operating.

## **Additional safety warnings**

- Keep hands and feet away from the cutting devices at all times and especially when switching the product on. Check the hedges and bushes for foreign objects, e.g. wire fences and hidden wiring;
- Do not try to grasp or remove trimmings when the product is running. Only remove trimmings when the product is switched off and remove the battery pack.
- Never hold the product by the guard. Hold the hedge trimmer properly, e.g. with both hands if two handles are provided;
- Never use the product standing on steps or a ladder. Do not work over shoulder height.
- Always ensure the safety guard supplied is fitted before using the product. Never attempt to use an incomplete product or one fitted with an unauthorized modification.
- Check cutting device regularly for damage, and if damaged repair immediately.

- Do not overload the product.
- Check immediately if the product starts to vibrate abnormally. Excessive vibration can cause injury.
- Switch the product off when the cutting device is blocked. Remove the battery pack and clear the blockage. Inspect the cutting device for damage before using the product again.
- Follow the maintenance and repair instructions for this product. Never carry out any modifications of the product. Information about maintenance and repair is provided in this user manual.
- Know how to stop the product quickly in an emergency.
- Do not expose to rain. Do not operate the product on a wet hedge.
- Use the product only in daylight or good artificial light.
- Prolonged use of the product exposes the user to vibrations that can cause a range of conditions collectively known as hand-arm vibration syndrome (HAVS) e.g. fingers going white; as well as specific diseases such as carpal tunnel syndrome.
- To reduce this risk when using the product, always wear protective gloves and keep your hands warm.
- The symptoms of HAVS include any combination of the following: Tingling

and numbness in the fingers; Not being able to feel things properly; Loss of strength in the hands; Fingers going white (blanching) and becoming red and painful on recovery (particularly in the cold and wet, and probably only in the tips at first). Seek medical advice immediately if such symptoms are experienced.

## **Maintenance and storage**

- Disconnect the product from the power supply (i.e. remove the plug from the power supply or the battery pack) and check for damage after use.
- Disconnect the product from the power supply (i.e. remove the plug from the power supply or the battery pack) before carrying out maintenance or cleaning work.
- Use only the manufacturer's recommended replacement parts and accessories.
- Inspect and maintain the product regularly. Have the product repaired only by an authorised service centre or similar qualified specialist.
- When not in use, store the product out of the reach of children.

## Vibration and noise reduction

To reduce the impact of noise and vibration emission, limit the time of operation, use low-vibration and low-noise operating modes as well as wear personal protective equipment.

Take the following points into account to minimize the vibration and noise exposure risks:

- Only use the product as intended by its design and these instructions.
- Ensure that the product is in good condition and well maintained.
- Use correct application tools for the product and ensure they in good condition.
- Keep tight grip on the handles/gripping surface.
- Maintain this product in accordance with these instructions and keep it well lubricated (where appropriate).
- Plan your work schedule to spread any high vibration tool use across a longer period of time.

## Emergency

Familiarise yourself with the use of this product by means of this instruction manual. Memorise the safety directions and follow them to the letter. This will help to prevent risks and hazards.

- Always be alert when using this product, so that you can recognise and handle risks early. Fast intervention can prevent serious injury and damage to property.
- Switch off and disconnect from the power supply if there is any malfunction. Have the product checked by a qualified specialist and repaired, if necessary, before you put it into operation again.

## Residual risks

- Even if you are operating this product in accordance with all the safety requirements, potential risks of injury and damage remain. The following dangers can arise in connection with the structure and design of this product:
- Health defects resulting from vibration emission if the product is being used over long periods of time or not adequately managed and properly maintained.

- Injuries and damage to property due to broken application tools or the sudden impact of hidden objects during use.
- Danger of injury and property damage caused by flying objects.



**WARNING!** This product produces an electromagnetic field during operation! This field may under some circumstances interfere with active or passive medical implants! To reduce the risk of serious or fatal injury, we recommend persons with medical implants to consult their doctor and the medical implant manufacturer before operating this product!

# Warning symbols on the power tool



WARNING!



The product complies with the applicable European directives and an evaluation method of conformity for these directives was done.



To reduce the risk of injury, the user must read the instruction manual.



Wear ear protection.



DANGER-Keep hands away from blade



WARNING-Do not expose to rain



Guaranteed sound power level.



Remove battery pack before repair and maintenance.



This symbol is known as the 'Crossed-out Wheelie Bin Symbol'. When this symbol is marked on a product or battery, it means that it should not be disposed of with your general household waste. Some chemicals contained within electrical/electronic products or batteries can be harmful to health and the environment. Only dispose of electrical/electronic/battery items in separate collection schemes, which cater for the recovery and recycling of materials contained within. Your cooperation is vital to ensure the success of these schemes and for the protection of the environment.

## Warning symbols on the charger



Before use, carefully read through the user manual.



The charger is for indoor use only.



Class II equipment.



Pole orientation.

## Warning symbols on the battery



Do not dispose of batteries in rivers or immerse in water.



Do not subject the battery to strong sunlight over long periods, and do not leave it on a heater (max. 50°C).



Do not throw on fire.



Contains a Li-ion battery. Batteries must be recycled or disposed of properly.



Return exhausted batteries to your local collection or recycling point.

# In the Box

## Parts

1. Working head
2. Shear blade
3. Hedge trimmer
4. Working head adjusting button
5. Rubber handle
6. Battery compartment
7. ON/OFF switch
8. Safety switch
9. Blade cover
10. Battery pack
11. Charging indicator light
12. Adaptor plug
13. Charger

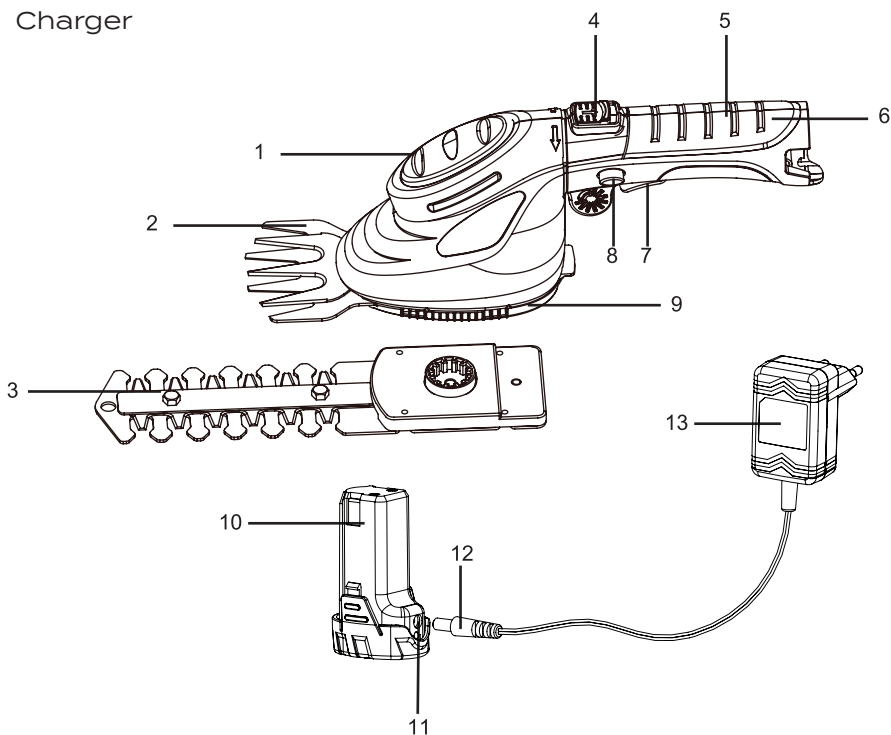

# Assembly the Mini Shear & Hedge

1. Unpack all parts and lay them on a flat, stable surface. Remove all packing materials and shipping devices if applicable.
2. Make sure the delivery contents are complete and free of any damage. If you find that parts are missing or show damage, do not use the product but contact the aftersales service within 28 days of purchase. Using an incomplete or damaged product represents a hazard to people and property.
3. Ensure that you have all the accessories and tools needed for assembly and operation. This also includes suitable personal protective equipment.



## WARNING!

This mini grass shear& trimmer is fully assembled with shear. There is no additional assembly except you need to use trimmer head.

## Install the battery pack

Insert the battery pack to battery compartment firmly. Always insert it all the way until it locks in place with a click sound.

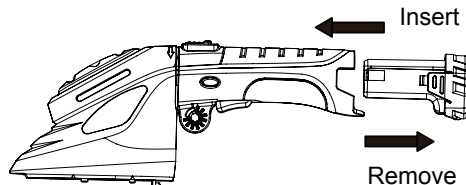

## Charging the battery



## WARNING!

The charger and battery pack are specifically designed to work together so do not attempt to use any other devices. Never insert or allow metallic objects into your charger or battery pack connections; an electrical failure and hazard will occur.

The battery needs to be charged before first use and whenever it fails to produce sufficient power on jobs that were easily done before.



**WARNING! NEVER LEAVE THE BATTERY AND CHARGER UNATTENDED WHEN CHARGING THE BATTERY.**

This product comes with a lithium-ion battery pack. Lithium-ion batteries don't lose charge when not in use, and don't lose charging capacity over time. Nevertheless, it is best practice to charge the battery when empty or insufficient to do the job.

## The charging procedure

1. Insert the the adaptor plug into the battery pack.
2. Connect the charger to a power supply.
3. The red charging indicator light will illuminate when it's under charging.
4. Complete charging, charging indicator light will turn from red to green.

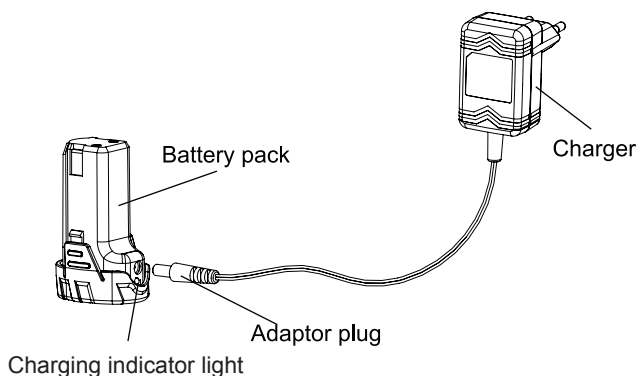

**WARNING!**

Once the battery is fully charged, disconnect the charger from the mains and remove the battery pack from the charger.



**WARNING!**

It is not recommended to charge the battery pack immediately after using the machine. The battery pack should be cooled for a period of time.



**WARNING!**

Charging time varies from different battery pack capacities.

## Important charging notes

1. Never allow the battery to completely discharge before recharging. The battery pack should be placed on the charger whenever the battery pack is noticeably running down or the tool no longer performs a task it previously performed.
2. Avoid conducting short charges. Make sure that the battery is fully charged each time by allowing the charger to complete its full charging cycle.
3. Avoid allowing loose items like screws or nails, etc., to be stored with battery packs, as these or similar items can short battery packs and cause a fire or explosion.
4. Always unplug the charger when not in use and store in a dry and secure place.
5. Avoid charging or storing your battery in temperatures below 0°C and above 40°C.
6. After use, allow the battery pack to cool down for approximately 30 minutes before attempting to recharge.  
If the battery pack does not charge properly:
  - Check the main socket by plugging in a lamp or other appliance.
  - Move the charger and battery pack to a location where the surrounding air temperature is approximately 18-24°C.
  - If charging problems persist, please contact service centre at 0345 605 2062.
7. The battery pack should be recharged when it fails to produce sufficient power on jobs which were easily done before. DO NOT CONTINUE to use under these conditions. Follow the charging procedure. You may also charge a partially used pack whenever you desire with no adverse effect on the battery pack.
8. Under certain conditions with the charger plugged into the power supply, the exposed charging contacts inside the charger can be shorted by foreign materials. Foreign materials of a conductive nature, such as, but not limited to, steel wool, aluminium foil, or any build-up of metallic particles, should be kept away from charger cavities. Always unplug the charger from the power supply when there is no battery pack in the cavity. Unplug the charger before attempting to clean.
9. Do not immerse the charger in water or any other liquid.



### **WARNING!**

Never attempt to open the battery pack for any reason. If the plastic housing of the battery pack breaks or cracks, dispose of the battery pack in accordance with local regulations; do not put it into further use.

## **Operating the Mini Shear & Hedge**

### **Switching on/off**

#### **Switching on**

Push safety switch and then press the ON/OFF switch on the handle. Release the safety switch.

#### **Switching off**

Release the ON/OFF switch the handle.

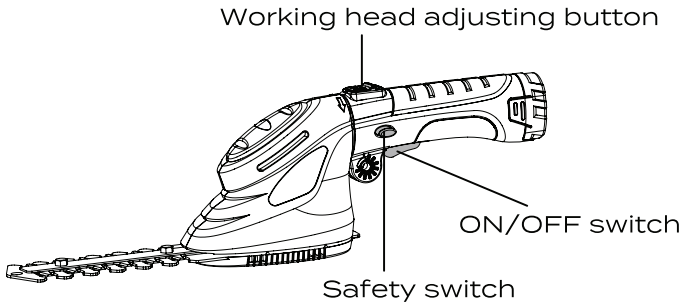

### **Adjust the working head**

1. Slide the working head adjusting button up and then turn the working head to the desired position. Again and check whether the working head is locked in place.
2. Release the button.

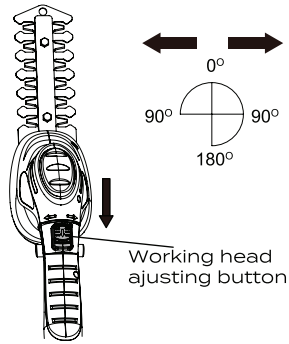

**WARNING!**

Adjust the working head only while the cutting device is not operating.

**Change the timmer/shear head**



**WARNING!**

Always remove the battery pack before adjusting or changing the moveable blade or cleaning.



**WARNING!**

Wear safety gloves when working on blades and close to it!



**WARNING!**

When replacing the blade, be careful to hold the machine firmly. Keep all parts of the body away from the blade and keep bystanders away.

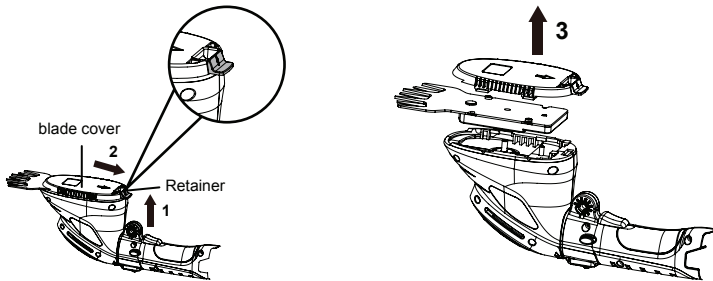

1. Hold the shear with one hand, then use the other hand to lever the retainer upwards and remove the blade cover. Then take off the shear blade.

2. Install the trimmer blade and then attach the blade cover align the two lines, push the blade cover forwards until the retainer fit in a suitable position.

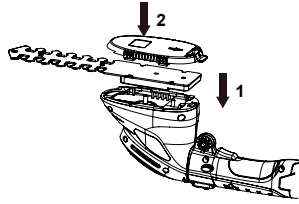

## Important tips

1. Unit is fully assembled. Remove clear plastic blade guard before use and save it to use as blade-cover when unit is not in use.
2. Battery must be charged before use. Please refer to battery charging instructions.
3. If the blade becomes jammed on a branch while cutting, IMMEDIATELY release trigger and clear jam. If you continue to hold trigger with blade jammed you will damage the motor.
4. IMPORTANT: This is a powerful tool that is remarkably easy and comfortable to use. As such, please pay attention to the placement of the blades while using to avoid cutting yourself.



### **WARNING!**

Always check the hedges and bushes for foreign objects, e.g. wire fences and hidden wiring before you start trimming.

# Maintenance and storage

## Maintenance



### **WARNING!**

**This product does not contain any parts that can be repaired by the consumer. Contact an authorised service centre or a similarly qualified person to have it checked and repaired.**



### **WARNING!**

**Always switch the product off, remove battery pack and let the product cool down before performing inspection, maintenance and cleaning work!**

## General cleaning

- Regular and proper cleaning will help ensure safe use and prolong the life of the product.
- Inspect the product before each use for worn and damaged parts. Do not operate it if you find broken and worn parts.
- Keep all nuts, bolts and screws tight to be sure that the product is in safe working condition.
- Check that the guards are undamaged and correctly fitted. Carry out necessary maintenance or repairs before using.

## Blade maintenance



### **WARNING!**

**Wear safety gloves when working on blades and close to it! Use appropriate tools to remove debris, e.g. a brush or wooden stick! Never use your bare hands!**

- Keep the blades clean and free of debris. Remove trimmings.
- Apply a small amount of suitable lubricant, like gear grease, on the cutting device to retain a good cutting performance.

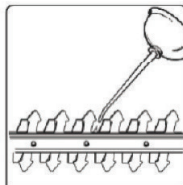

## Storage and transport

This product does not contain any parts that can be repaired by the consumer. Contact the after sales support if you have any queries.



- After cleaning the unit thoroughly. Store the unit in a safe, dry room, allowing the motor to cool down beforehand.
- Store the product out of the reach of children.
- Use the original packaging whenever possible.
- Always carry the product by its handles/gripping surfaces.
- Protect the product from any heavy impact or strong vibrations which may occur during transportation in vehicles.
- Secure the product to prevent it from slipping or falling over.

# Troubleshooting

Although your new cordless hedge trimmer is really easy to operate, if you do experience problems, please check the following:

<b>Problem</b>	<b>Possible cause</b>	<b>Solution</b>
Can't turn on	<ol style="list-style-type: none"> <li>1. Battery not fully connected</li> <li>2. Low battery capacity</li> <li>3. Battery stored outside of battery temperature</li> </ol>	<ol style="list-style-type: none"> <li>1. Remove the battery and reinsert it.</li> <li>2. Recharge battery; also see "Charging The Battery"</li> <li>3. Allow battery to warm/ cool naturally to room temperature (within battery operating temperature 10-40 °C)</li> </ol>
Blade not cutting properly	<ol style="list-style-type: none"> <li>1. The shear/trimmer blade is not fully installed in place.</li> <li>2. Too much friction, due to lack of lubricant.</li> <li>3. Debris is stuck between the blades.</li> </ol>	<ol style="list-style-type: none"> <li>1. Install the shear/trimmer blade correctly; Refer to "Change the trimmer/shear head"</li> <li>2. Apply lubricant spray</li> <li>3. Use appropriate tools to remove debris. Refer to "Blade maintenance"</li> </ol>
Battery charge indicator does not light up	<ol style="list-style-type: none"> <li>1. Mains plug of battery charger not plugged in (properly)</li> <li>2. Socket outlet, mains cable or battery charger defective</li> </ol>	<ol style="list-style-type: none"> <li>1. Insert mains plug (fully) into the socket outlet</li> <li>2. Contact service centre at 01904 727 509</li> </ol>
Temperature extremely high	Product has overheated	Please let the machine to cool completely.

# Technical Data

Model no.	ET1501
Voltage	3.6V 
Cutting length of trimmer	110mm
Cutting width of shear	80mm
Net weight	0.822kg
No load speed	1000/min
<b>Battery pack</b>	
Model	ET-DO361
Voltage	3.6V 
Battery type	Lithium-Ion
Battery capacity	1.5Ah
Fully charging time	3-5Hour
<b>Charger</b>	
Model	JLHO30600400B
Input	100-240VAC 50-60Hz 8W
Output	6.0VDC 0.4A 2.4W
Insulation protection class	II
<b>Noise and vibration data</b>	
A-weighted sound pressure level	Hedge trimmer: $L_{pA}=75.20$ dB(A) K=3 dB(A) Grass shear: $L_{pA}=75.20$ dB(A) K=3 dB(A)
A-weighted sound power level	Hedge trimmer: $L_{wA}=88$ dB(A) Grass shear: $L_{wA}=86.63$ dB(A) K=3 dB(A)
Guaranteed sound power level	88 dB(A)
Typical weighted vibration	$a_h < 2.5$ m/s <sup>2</sup> K=1.5m/s <sup>2</sup>
<b>Part Number</b>	<b>Accessories</b>
ABBH081003	shear lower blade
ABBH081004	shear upper blade
ABBH081042	trimmer lower blade
ABBH081042	trimmer upper blade

**WARNING!**

The sound values have been determined according to the noise test code given in EN 62841-4-2 and EN IEC 62841-4-5.

The sound intensity level for the operator may exceed 80dB(A) and ear protection measures are necessary.

The declared vibration value (according to EN 62841-4-2 and EN IEC 62841-4-5) has been measured in accordance with a standard test method, and may be used for comparing one product with another. The declared vibration value may also be used in a preliminary assessment of exposure.

Depending on the actual use of the product, the vibration values can differ from the declared total. Adopt proper measures to protect yourself against vibration exposures. Take the whole work process into consideration, including times the product is running under no load or switched off.

**WARNING!**

This tool may cause Hand-Arm Vibration Syndrome (HAVS) if its use is not adequately managed.

Preventative measures include, among others, regular maintenance and care of the product and cutting attachments, keeping hands warm and periodical breaks, as well as proper planning of work processes.

## Recycling and Disposal

Waste electrical products should not be disposed with household waste. Please recycle where facilities exist.

Check with your local authority or retailer for recycling advices.

## Disposal

The hedge trimmer and its accessories are made of various recyclable materials. Dispose of the hedge trimmer in accordance with your local recycling regulations.

# Getting Help

Our dedicated UK-based customer helpline is open 7 days a week to assist you with assembly, parts queries and technical support. We are open during office hours but you can always send an email via **support@coreservice.co.uk**. Our experts are here to get you back enjoying your garden in no time.

For useful assembly, starting and maintenance videos, and for ordering spares, please visit **www.coreservice.co.uk**.

Using our service does not affect your statutory rights.

# Warranty

This product is covered by a 1 year warranty.

The warranty covers any manufacturing defect in materials, workmanship and finish.

Any claim under this warranty must be made by going to your nearest The Range store, taking your proof of purchase with you, and claims must be made within 1 year of the date of purchase.

We will offer you a free repair of the item where this is possible, or a replacement or a refund. Your statutory rights remain unaffected, in particular any rights you may have under the Consumer Rights Act 2015.

This warranty is given by CDS Group, Plymouth, PL6 5ZD  
CDS Group, Dublin, DO2 AY28 .

Please note: This warranty does not apply to products misused or neglected and only covers domestic use. It does not apply to commercial use of the product. The warranty period for the battery pack and charger is 1 year.