



# SPEAR & JACKSON

**INSTRUCTION  
MANUAL**

WINDOW VACUUM CLEANER

**3.6V  
WVC10**



AFTERSALES SERVICE  
**01904 727505**  
MON-FRI 9am-5pm SAT/SUN 11am-4pm  
[www.spearandjackson-power.com](http://www.spearandjackson-power.com)



**Important** - Please read these instructions fully before operating or maintaining your window vac

These instructions contain important information that will help you get the best from your window vacuum cleaner.

# THANK YOU!

Dear Customer,

Thank you for choosing a Spear and Jackson window vacuum cleaner. Spear and Jackson was founded in 1760 in the city of Sheffield, which is world famous for the production of steel, cutlery and garden and hand tools. Through continuous innovation and the use of new technologies and materials, Spear and Jackson has gained an enviable reputation as a supplier of reliable, high performance and high quality products designed to make your work in the garden as easy and enjoyable as possible.

## FREE EXTENDED WARRANTY

We are so confident in the quality of our products we provide a 2 year guarantee on our power tools. We offer 12 month extended warranty for all registered power tools. Simply register your product within 28 days of purchase via [www.spearandjackson-power.com](http://www.spearandjackson-power.com) to extend the standard manufacturer's warranty with an additional 12 months. After registering your product, your power tool will be covered for parts and labour for 3 years from the date of purchase, subject to the terms of the guarantee. If you do not wish to register your product within 28 days, your product is guaranteed for 1 year after date of purchase. It's important to retain your proof of purchase.

## 7 DAYS A WEEK TECHNICAL SUPPORT

We want you to get the best out of your products. Our easy-to-read instruction manual guides you with best practice use and maintenance tips. You can also visit [www.spearandjackson-power.com](http://www.spearandjackson-power.com) for online help, general tips and useful videos about your garden product. However if you prefer to speak to one of technicians please call **01904 727505, Mon-Fri 9am-5pm and Sat-Sun 11am-4pm**, we can solve around 80% of questions directly over the phone.

We hope you enjoy your product and looking forward to any feedback, as this allows us to develop even better products for the future.

# CONTENTS

<b>Safety Information</b> .....	<b>04</b>
Description of symbols .....	.04
General safety .....	.05
Personal safety .....	.05
Operating safety .....	.05
Maintenance and storage .....	.06
Intended use .....	.06
<b>Box Content / Parts</b> .....	<b>07</b>
<b>Assembly</b> .....	<b>08</b>
Assemble the appliance .....	.08
Fill the spray bottle .....	.08
Attach the wiping attachment .....	.08
<b>Operation</b> .....	<b>09</b>
Charge the battery .....	.09
Start working .....	.10
Interrupting the work .....	.10
Emptying the reservoir during operation .....	.10
<b>Maintenance</b> .....	<b>11</b>
Cleaning of window vacuum cleaner .....	.11
UK plug .....	.11
<b>Technical Data</b> .....	<b>12</b>
<b>Troubleshooting</b> .....	<b>13</b>
<b>Guarantee</b> .....	<b>14</b>

# SAFETY INFORMATION

Please read these instructions fully before operating or maintaining your machine

## DESCRIPTION OF SYMBOLS

The following warning symbols appear throughout this manual and indicate the appropriate safety measures you should take when operating and maintaining the window cleaner.



### IMPORTANT!

Please read all of the safety and operating instructions carefully before using this tool. Please pay particular attention to all sections of this user guide that carry warning symbols and notices.



### WARNING!

This is a warning symbol. This symbol is used throughout the user guide whenever there is a risk of personal injury. Ensure that these warnings are read and understood at all times.



**Double insulations, Class II appliance.**



### Waste Disposal and Environmental Protection!

Be environmentally friendly. Return the tool, accessories and packaging to a recycling centre when you have finished with them.

Electrical machines do not belong in domestic waste.

Take the equipment to a waste disposal site. The plastic and metal parts that are used can be separated out into pure grade, which allows recycling.



Symbol for battery separate collection.



The charger is for indoor use only.



Pole orientation.



Class III appliance



The product complies with the applicable European directives and an evaluation method of conformity for these directives was done.



Products marked with this symbol are equipped with a type of OTP

# SAFETY INFORMATION

Please read these instructions fully before operating or maintaining your machine

## GENERAL SAFETY



### IMPORTANT!

- This appliance is not intended for use by persons (including children) with reduced physical, sensory or mental capabilities, or lack of experience and knowledge, unless they have been given supervision or instruction concerning use of the appliance by a person responsible for their safety. Children should be supervised to ensure that they do not play with the appliance.

### Information regarding the battery

- Short circuit hazard! Do not insert conductive objects (such as screwdrivers or similar) into the charger plug.
- You must recharge the battery using only the original charger provided with the appliance.
- This appliance can be used by children aged from 8 years and above and persons with reduced physical, sensory or mental capabilities or lack of experience and knowledge if they have been given supervision or instruction concerning use of the appliance in a safe way and understand the hazards involved. Children shall not play with the appliance. Cleaning and user maintenance shall not be made by children without supervision.
- The appliance must be disconnected from the supply mains when removing the battery.

### Information regarding the Battery Transportation

- The battery has been tested as per the relevant directives for international transport and can be transported/shipped.

## PERSONAL SAFETY



### WARNING!

- Prior to using this appliance on sensitive (high shine) surfaces, test the micro-fiber wiping pad at an inconspicuous location.
- The appliance must be charged by the charger supplied with output voltage of 4.2Vdc and output current of 500mA.
- The operator or user is responsible for accidents or damages to other people or their property.

## OPERATING SAFETY



### WARNING!

- Do not insert objects into the air vents.
- Do not spray jet into eyes.
- Do not direct the spray jet directly on equipment containing electrical components, such as the interior of ovens.
- Do not overreach. Proper footing and balance is a must at all times while using the appliance.
- In case of visual damage, replace the charger with charger cable immediately by original parts.
- Only use and store the charger in dry rooms, ambient temperature 5 - 40° C.
- Never touch the mains plug with wet hands.

# SAFETY INFORMATION

Please read these instructions fully before operating or maintaining your machine

## MAINTENANCE AND STORAGE



### WARNING!

- To ensure the appliance safety, use only original spare parts from the manufacturer or approved by the manufacturer.
- Retrofitting or making any unauthorized changes to the machine, as well as the use of unapproved parts will invalidate your warranty.
- Do not attempt to repair the equipment yourself. All work not indicated in these instructions is to be carried out only by service stations authorized by us.
- Store the equipment in a dry location and out of reach of children.
- Handle the equipment with care. Keep the equipment clean for safe and more efficient working. Follow the maintenance directions.

## INTENDED USE

This window vacuum is designed for domestic use only:

- For cleaning wet, smooth surfaces such as windows, mirrors or tiles.
- It is not intended for vacuuming dust.
- It is also not intended for vacuuming larger amounts of fluids from horizontal surfaces, such as spillage from a drinking glass.
- Only use this appliance with conventional window cleaning products (no spirit or foam cleaners).
- Usage extending beyond this is not considered as intended use.

Any use of the machine that deviates from its intended use and is not included in these instructions is considered unauthorized use and relieves the manufacturer from his or her legal liability.

# BOX CONTENT

## PARTS

- 1 Charger with charging cable
- 2 Charging cable plug
- 3 Charging socket
- 4 Charge/operation indication
- 5 ON/OFF switch
- 6 Handle
- 7 Dirt water tank
- 8 Dirt water tank plug
- 9 Suction head (attachment) with removable lip
- 10 Suction nozzle
- 11 Removable suction lip (suction bar)
- 12 Spray bottle
- 13 Fastening ring for the wiper attachment
- 14 Spray lever
- 15 Wiping attachment
- 16 Micro-fibre wiping pad
- 17 Spray head

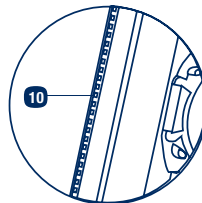
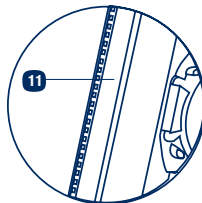
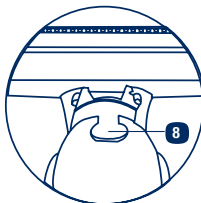
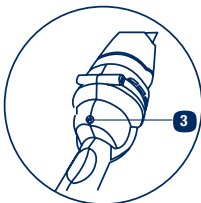
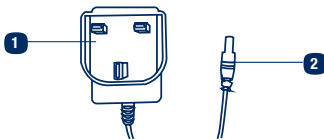
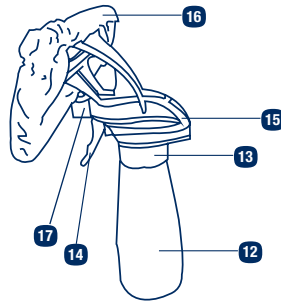
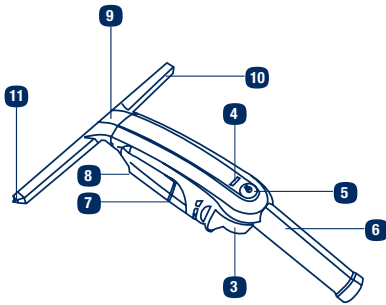

If there are any parts missing, please call the customer helpline on 01904 727505

# ASSEMBLY

## 1 Assemble the appliance

- i. Line up the arrow on the suction head with the arrow on the top right hand side of the appliance.
- ii. Insert the suction head into the appliance and rotate 90° clockwise until it is secured.

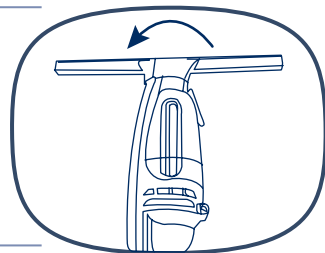

## 2 Fill the spray bottle

- i. Assemble the wiping attachment (16) onto the fastening ring (13) through the spray head (17).
- ii. Align the buckles on both sides of the wiping attachment with the notches of the fastening ring. Push the wiping attachment completely onto the fastening ring until they are locked together.
- iii. Fill the spray bottle with water and detergent. (please ensure you do not use a detergent that affects plastics or you may damage the product).
- iv. Screw the spray bottle head to the spray bottle.

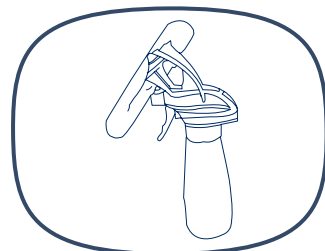
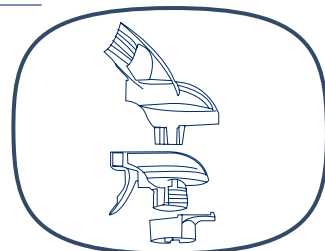

## 3 Attach the wiping attachment

Attach the wiper pad to the wiper attachment and secure with Velcro.

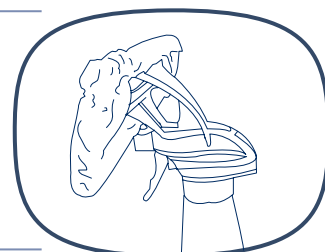

# OPERATION

## Charge the battery



**WARNING** - Use only with the original charger provided with this appliance.

- i. Ensure the appliance is switched off.
- ii. Plug the charger supplied with the appliance into the mains.
- iii. Insert the charging cable plug into the charging socket on the back of the appliance.
- iv. The charging indicator blinks during the charging process. Charging time is around 3~5 h.
- v. When the battery is fully charged, the indicator will stay permanently illuminated. Operation time with full charge is approx 20min.

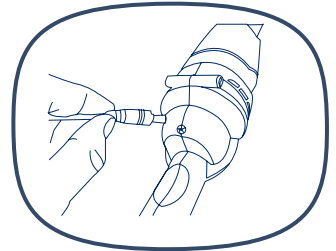

**NOTE!** During the charging process, the charge/operating indicator blinks. Once the battery is fully charged, it will be permanently illuminated.

If the battery is low, the charge/operation indicator starts twinkling slowly in red and the appliance switches off after a certain time. If this is the case, charge the battery.

The appliance can be switched off while the spray bottle is in use. This significantly increases the operating time per battery charge.

# OPERATION

## Start working

- i. Press the spray lever on the bottle to apply the detergent and spray the surface evenly; after that, loosen the dirt using the wiping pad.

**NOTE!** Rinse pad under running water if needed!

- ii. Press the ON/OFF switch to switch the window vacuum cleaner on, the charge/operations indicator will illuminate.

**IMPORTANT!** Prior to use, ensure that the suction nozzle and removable suction lip are free of dirt.

- iii. Pull the appliance from the top to the bottom to vacuum up the detergent. Hard to reach areas can be vacuumed vertically or horizontally (limited areas).

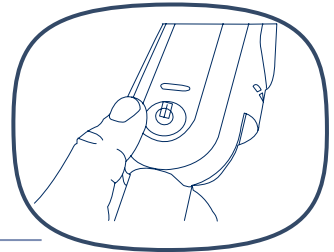
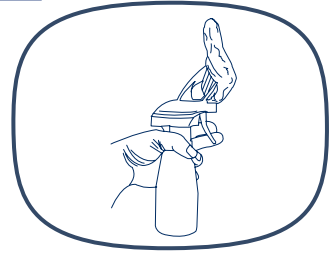

## Interrupting the work

- i. Press the ON/OFF switch to switch off the appliance.

## Emptying the reservoir during operation

- i. Once the max level (mark) of the dirt water tank is reached, please empty the tank.
- ii. Press the ON/OFF switch to turn off the appliance.
- iii. Pull off the plug of the dirt water tank and empty the tank.
- iv. Put back the plug to close the dirt water tank.

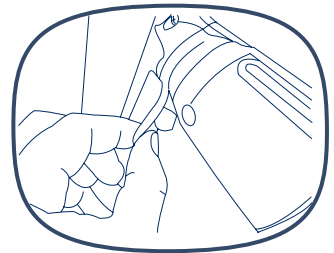

# MAINTENANCE



## WARNING! DANGER OF ELECTRIC SHOCK!

Unplug the charger from the mains before carrying out any cleaning of the appliance.

### Cleaning of the window vacuum cleaner

- i. Always keep the device clean, dry and free of oil or grease.
- ii. Avoid getting the electrical part of the appliance wet or come in contact with any liquid.
- iii. Press the ON/OFF switch to turn off the appliance.
- iv. Turn the suction head anticlockwise 90° and remove it from the appliance.
- v. Clean the suction nozzle under running water (not dishwasher safe).

**CAUTION!** The appliance contains electrical components. Do not clean this under running water!

- vi. Remove the Micro-fibre wiping pad from the wiping attachment and rinse it under running water. The Micro-fibre wiping pad can also be washed in the washing machine at a temperature of up to 60°C (without the use of fabric softeners).
- vii. Let the cleaned appliance dry prior to assembly.
- viii. Use a cloth to clean the housing. Never use petrol, solvents or cleaning agents that might damage or dissolve plastic.

---

## UK plug

If you need to replace the fitted plug, then this must be replaced using a BS1363/A Mains plug fitted with a BS1362 approved fuse of identical value to the original fuse. Proceed as follows:

**IMPORTANT:** The wires in the mains lead are coloured in accordance with the following code:

Blue – Neutral, Brown – Live

In case the colours of the wires in the mains lead don't match the colour marking on the terminals, please proceed as follow.

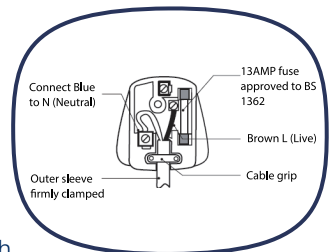

Connect the blue wire to the terminal marked N (Neutral) or coloured black. The brown wire must be connected to the terminal marked L or coloured red.



# TECHNICAL DATA

Model	WVC10
Rated voltage	3.6V 
Rated power	10W
Ingress protection rating	IPX4
Volume of dirt water tank	80ml

## Charger

Input voltage/power	230-240V ~ , 50-60Hz, 5.5W
Output voltage/current	4.2V  500mA
Charging time	3-5h
Operation time with full charge	Approx. 20min.
Protection class	

## Battery

Battery type	Li-Ion
Nominal voltage	3.6V 
Capacity	2000mAh
Weight	0.52 kg

Part number	Accessories
WVC-01	Window fibre pads
WVC-02	Bottle
WVC-03	Suction head
WVC-04	Suction lip
WVC-05	Spray head

# TROUBLESHOOTING

## **Spray bottle does not spray**

- Refill water and detergent.
- Pump mechanism in the spray bottle is defective, contact dealer.

## **Machine does not start**

Check the charge/operations indicator:

- No signal or slowly blinking signal: Charge the battery.
- With a rapidly blinking signal: Inform your dealer.

## **Streaks while cleaning**

- Clean the removable lip.

## **Water is leaking from the air vents**

- Empty the dirt water reservoir (max. 100 ml content).

# GUARANTEE

If your device develops a fault, please don't hesitate to contact our customer service department on 01904 727505, we can solve 80% of problems via the phone.

1. These guarantee terms cover additional guarantee rights and do not affect your statutory warranty rights. All our products are covered by a two year manufacturer guarantee unless this product was registered within 28 days of purchase via [www.spearandjackson-power.com](http://www.spearandjackson-power.com) and therefore obtained an additional 12 month warranty.
2. Claims must be accompanied by Proof of Purchase. This must be in the form of a Sales receipt or Bank statement and must show that the product has been purchased within the guarantee period as described under point 1, from the retailer that it was originally bought from. Please keep your receipt safe or staple it to the back of this manual for future reference.
3. Our guarantee covers problems caused by material or manufacturing defects, and will result in the repair of these defects or replacement of the device with a like for like or similar article.
4. Our devices have not been designed for commercial, trade or industrial applications, any signs of use of the equipment in these application or equivalent activities, invalidates the guarantee.
5. The following are also excluded from our guarantee:
  - A. Faults due to accidents, customer misuse or unauthorized repairs
  - B. Consumable Parts such as Micro-fibre wiping pad, suction head, spray lever, charger, and other accessories that are compatible with the product.
  - C. Failure due to lack of routine maintenance.
  - D. Failure as a result of not using the equipment in accordance with the manual and safety instructions
  - E. The adjustment of cables, drives belts or recoil starters.
  - F. Batteries and battery packs are excluded from the extended warranty.

Guarantee claims should be submitted before the end of the guarantee period, see point 1. The original guarantee period remains applicable to the device even if repairs are carried out or parts are replaced. In such cases, the work performed or parts fitted will not result in an extension of the guarantee period, and no new guarantee will become active for the work performed or parts fitted.

If you have any problems or questions concerning your power tool, please contact our after sales service at 01904 727505 or visit [www.spearandjackson-power.com](http://www.spearandjackson-power.com).

# EC DECLARATION OF CONFORMITY

## We

SUMEC Hardware &Tools Co.,Ltd.  
1XinghuoRD.,Nanjing,China  
And our branch office  
SUMEC UK Co.,Ltd.  
Unit A&B Escrick Business Park  
Escrick,York YO19 6FD

Window vacuum cleaner  
Factory No. : PT1433501  
Model No: WVC10  
Function: Clean windows  
Serial number: WVC10-150001-151194

EMC Directive: 2004/108/EC  
RoHS Directive: 2011/65/EU  
WEEE Directive 2012/19/EU

## Standards conform to:

EN 55014-1/A2:2011 EN 55014-2/A2:2008  
EN61000-3-2  
EN61000-3-3  
EN60335-1:2012+A11  
EN60335-2-2:2010+A11+A1  
AfPS GS 2014:01  
EN62233:2008

Authorized Signatory

Date: \_03-12-2015\_\_\_\_\_

Signature: 

Name: Mr. Liu Kai

General Manager

SUMEC Hardware & Tools Co.,Ltd.

