



**SPEAR &
JACKSON**

ORIGINAL INSTRUCTION MANUAL

36V

Cordless Chainsaw

S3635CC



**Important - Please read these instructions
fully before starting assembly**

These instructions contain important information that will help you get the best from your chainsaw, ensuring it is assembled correctly and safely. If you need help or have damaged or missing parts, call the Customer Helpline on 0345 605 2067

**AFTER SALES SUPPORT
0345 605 2067**

SAN NO.: 0321/8019/70ZA

SPEAR & JACKSON SINCE 1760

For more than 250 years gardeners have enjoyed high quality performance and great results using Spear & Jackson tools.

Our garden power tools combine continuous innovation and the latest in manufacturing technologies with a proud heritage.

Each product is carefully designed with performance, comfort and durability firmly in mind, which has earned Spear & Jackson an enviable reputation as a maker of tools to trust.

3 YEAR GUARANTEE

As a testament to the quality of our products, we offer a 3 year manufacturers warranty and a comprehensive after sales service.

The warranty covers manufacturing faults, however in the event that the item has been deliberately damaged, used in a commercial environment or disassembled then the warranty will be null and void.

Please retain proof of purchase.

7 DAYS A WEEK TECHNICAL SUPPORT

We want you to get the best out of our products. Our easy-to-read instruction manual guides you with best practice use and maintenance tips. Please call **0345 605 2067** for technical support, we can solve around 80% of questions directly over the phone.

We hope you enjoy your product and we look forward to any feedback, as this allows us to develop even better products in the future.

CONTENTS

Safety Information	04
Description of symbols	04
Warning symbols on the charger	05
Warning symbols on the battery pack	05
General safety	06
Additional safety instructions for batteries and chargers	10
Chain saw safety warnings	14
Intended use	18
Box Contents / Parts	19
Assembly	20
Unpacking.....	20
Checking the chain tension.....	20
Filling oil tank.....	21
Installing or removing battery pack.....	22
Checking battery capacity.....	23
Charging the battery pack.....	23
Operation	25
Maintenance	32
Disposal	39
Troubleshooting	40
Technical Data	41
Warranty	43

SAFETY INFORMATION

Please read these instructions fully before operating or maintaining your machine

DESCRIPTION OF SYMBOLS

The following warning symbols appear throughout this manual and indicate the appropriate safety measures you should take when operating and maintaining the chainsaw.

 Please read the instruction handbook before operating this machine.

 **WARNING!** This is a warning symbol. This symbol is used throughout the user guide whenever there is a risk of personal injury. Ensure that these warnings are read and understood at all times.

 **Wear ear protection**

 **Wear eye protection**

 **Wear safety helmet**

 **Wear protect mask**

 **Wear protective gloves**

 **Wear proper safety shoes**

 Keep bystanders away. Thrown objects can cause serious injury

 Disconnect the battery pack before any repair or maintenance.

 Guaranteed sound power level in 96dB.

 Do not expose or operate the tool in rain.

 **DANGER!** Beware of kickback.

 Waste electrical products should not be disposed of with household waste. Please recycle where facilities exist. Check your Local Authority or retailer for recycling advice.

 The product complies with the applicable European directives and an evaluation method of conformity for these directives was done.

 Always use two hands when operating the product.

 Contact of the guide bar tip with any object should be avoided.

 Tip contact can cause the guide bar to move suddenly upward and backward which can cause serious injury.

 Rotation direction of chainsaw.

 In this position the brake is engaged and the chainsaw will not run or start.

 In this position the brake is disengaged and the chainsaw will start to operate.

SAFETY INFORMATION

Please read these instructions fully before operating or maintaining your machine

WARNING SYMBOLS ON THE CHARGER

 Read instruction handbook before operating this machine.

 The charger is for indoor use only.

 Double insulation.

 Pole orientation.

 Fuse 5A

 Waste electrical products should not be disposed of with household waste. Please recycle where facilities exist. Check your Local Authority or retailer for recycling advice.

WARNING SYMBOLS ON THE BATTERY PACK

 Batteries contain Li-ion, waste batteries should be sorted for eco-friendly. Do not dispose of waste batteries as unsorted municipal waste.

 Do not throw in water.

 Do not throw on fire.

 Do not subject the battery to strong sunlight over long periods and do not leave it on a heater (max.45°C).

 Do not dispose of batteries. Return exhausted batteries to your local collection or recycling point.

SAFETY INFORMATION

Please read these instructions fully before operating or maintaining your machine

GENERAL SAFETY

! **WARNING** Read all safety warnings and all instructions. Failure to follow the warnings and instructions may result in electric shock, fire and/or serious injury.

Save all warnings and instructions for future reference.

The term “power tool” in the warnings refers to your mains-operated (corded) power tool or battery-operated (cordless) power tool.

Work area safety

- Keep work area clean and well lit. Cluttered or dark areas invite accidents.
- Do not operate power tools in explosive atmospheres, such as in the presence of flammable liquids, gases or dust. Power tools

create sparks which may ignite the dust or fumes.

- Keep children and bystanders away while operating a power tool. Distractions can cause you to lose control.

Electrical safety

- Power tool plugs must match the outlet. Never modify the plug in any way. Do not use any adapter plugs with earthed (grounded) power tools. Unmodified plugs and matching outlets will reduce the risk of electric shocks.
- Avoid body contact with earthed or grounded surfaces, such as pipes, radiators, ranges and refrigerators. There is an increased risk of electric shocks. If your body is earthed or grounded.
- Do not expose power tools to rain or wet

SAFETY INFORMATION

Please read these instructions fully before operating or maintaining your machine

conditions. Water entering a power tool will increase the risk of electric shocks.

- Do not abuse the cord. Never use the cord for carrying, pulling or unplugging the power tool. Keep cord away from heat, oil, sharp edges or moving parts. Damaged or entangled cords increase the risk of electric shocks.
- When operating a power tool outdoors, use an extension cord suitable for outdoor use. When using a cord suitable for outdoor use, this will reduce the risk of electric shocks.

Personal safety

- Stay alert, watch what you are doing and use common sense when operating a power tool. Do not use a power tool while you are tired or under the influence of drugs, alcohol or medication. A moment of

inattention while operating power tools may result in serious personal injury.

- Use personal protective equipment. Always wear eye protection. Protective equipment such as dust mask, non-skid safety shoes, hard hat, or hearing protection used for appropriate conditions will reduce personal injuries.
- Prevent unintentional starting. Ensure the switch is in the off-position before connecting to a power source and/or battery pack, picking up or carrying the tool. Carrying power tools with your finger on the switch or energy sing power tools that have the switch on invites accidents.
- Remove any adjusting key or wrench before turning the power tool on. A wrench or a key left attached to a rotating

SAFETY INFORMATION

Please read these instructions fully before operating or maintaining your machine

part of the power tool may result in personal injury.

- Do not overreach. Keep proper footing and balance at all times. This enables better control of the power tool in unexpected situations
- Dress properly. Do not wear loose clothing or jewellery. Keep your hair, clothing and gloves away from moving parts. Loose clothes, jewellery or long hair can be caught in moving parts.
- If devices are provided for the connection of dust extraction and collection facilities, ensure these are connected and properly used. Use of dust collection can reduce dust-related hazards.

Power tool use and care

- Do not force the power tool. Use the correct power tool for your application.

The correct power tool will do the job better and safer at the rate for which it was designed.

- Do not use the power tool if the switch does not turn it on and off. Any power tool that cannot be controlled with the switch is dangerous and must be repaired.
- Disconnect the plug from the power source and/or the battery pack from the power tool before making any adjustments, changing accessories, or storing power tools. Such preventive safety measures reduce the risk of starting the power tool accidentally.
- Store idle power tools out of the reach of children and do not allow persons unfamiliar with the power tool or these instructions to operate the power tool. Power tools are dangerous in the hands of untrained users.

SAFETY INFORMATION

Please read these instructions fully before operating or maintaining your machine

- Maintain power tools. Check for misalignment or binding of moving parts, breakage of parts and any other condition that may affect the power tool's operation. If damaged, have the power tool repaired before use. Many accidents are caused by poorly maintained power tools.
- Keep cutting tools sharp and clean. Properly maintained cutting tools with sharp cutting edges are less likely to bind and are easier to control.
- Use the power tool, accessories and tool bits etc. in accordance with these instructions, taking into account the working conditions and the work to be performed. Use of the power tool for operations different from those intended, could result in a hazardous situation.

Battery tool use and care

- Recharge only with the charger specified by the manufacturer. A charger that is suitable for one type of battery pack may create a risk of fire when used with another battery pack.
- Use power tools only with specifically designated battery packs. Use of any other battery packs may create a risk of injury and fire.
- When a battery pack is not in use, keep it away from other metallic objects, like paperclips, coins, keys, nails, screws or other small metallic objects, that can make a connection from one terminal to another. Shorting the battery terminals together may cause burns or a fire.
- Under abusive conditions, liquid may be ejected from the battery; avoid contact. If contact accidentally occurs, flush with water.

SAFETY INFORMATION

Please read these instructions fully before operating or maintaining your machine

If liquid contacts eyes, additionally seek medical help. Liquid ejected from the battery may cause irritation or burns.

Service

Have your power tool serviced by a qualified technician using only identical replacement parts. This will ensure that the safety of the power tool is maintained.

ADDITIONAL SAFETY INSTRUCTIONS FOR BATTERIES AND CHARGERS

SAFETY WARNINGS FOR BATTERY PACK



WARNING! Read all safety warnings and all instructions. Failure to follow the warnings and instructions may result in electric shocks, fire and/or serious injury.

Save all warnings and instructions for future reference.

- Do not dismantle, open or shred cells or battery pack.
- Do not short-circuit a battery pack. Do not store battery packs haphazardly in a box or drawer where they may short circuit each other or be short-circuited by conductive materials. When the battery pack is not in use, keep it away from other metallic objects, like paper clips, coins, keys, nails, screws or other

SAFETY INFORMATION

Please read these instructions fully before operating or maintaining your machine

small metal objects, that can make a connection from one terminal to another. Shorting the battery terminals together may cause burns or a fire.

- Do not expose battery packs to heat or fire. Avoid storage in direct sunlight.
- Do not subject battery packs to mechanical shock.
- In the event of the battery leaking, do not allow the liquid to come into contact with the skin or eyes. If contact has been made, wash the affected area with copious amounts of water and seek medical advice.
- Seek medical advice immediately if a cell or battery pack has been swallowed.
- Keep the battery pack clean and dry.
- Wipe the battery pack terminals with a clean dry cloth if become dirty.
- Battery packs needs to be charged before use. Always refer to this instruction and use the correct charging procedure.
- Whilst the battery pack is being charge, refrain from any maintenance.
- After extended periods of storage, it may be necessary to charge and discharge the battery pack several times to obtain maximum performance.
- Battery pack gives its best performance when it is operated at normal room temperature (20 °C ± 5 °C).
- When disposing of battery packs, keep battery packs of different electrochemical systems separate from each other.
- Recharge only with the charger specified by the manufacturer. Do not use any charger other than that specifically provided for use with the

SAFETY INFORMATION

Please read these instructions fully before operating or maintaining your machine

equipment. A charger that is suitable for one type of battery pack may create a risk of fire when used with another battery pack.

- Do not use any battery pack which is not designed for use with the equipment.
- Keep battery pack out of the reach of children.
- Retain the original product literature for future reference.
- Remove the battery from the equipment when not in use.
- Dispose of the battery properly.

SAFETY WARNINGS FOR YOUR BATTERY CHARGER



WARNING! Read all safety warnings and all instructions. Failure to follow the warnings and instructions may result in an electric

shock, fire and/or serious injury.

Save all warnings and instructions for future reference.

- This appliance is not intended for use by persons (including children) with reduced physical, sensory or mental capabilities, or lack of experience and knowledge, unless they have been given supervision or instruction concerning use of the appliance by a person responsible for their safety.
- Children should be supervised to ensure that they do not play with the appliance.

Change to “Additional Safety Instructions For Your Battery And Charger”

- Before charging, read the instructions.
- After charging, disconnect

SAFETY INFORMATION

Please read these instructions fully before operating or maintaining your machine

the battery and charger from the supply mains. Then remove the chassis connection and then the battery connection.

- Do not charge a leaking battery.
- Do not use chargers for purposes in which they are not designed for.
- Before charging, ensure your charger is matching the local AC supply.
- Charge the battery indoors and use only in dry conditions.
- The charging device must be protected from moisture.
- Do not use the charging device in the open.
- Shorting the battery terminals together may cause burns or a fire.
- Respect the polarity “+/-“ when charging.
- Do not open the unit and keep out of the reach of children.

- Do not charge the batteries of other manufactures or ill-suited models.
- Ensure that the connection between the battery charger and battery is correctly positioned and is not obstructed by foreign bodies.
- Ensure the slot for the batter charger is clear and unobstructed. Store in a dry and frost-free place to protect against dirt and humidity.
- When charging batteries, ensure that the battery charger is in a well-ventilated area and away from inflammable materials. Batteries can get hot during charging” to “Batteries can heat up quickly whilst charging. Ensure that batteries and chargers are not left unsupervised during charging.
- Do not recharge non-rechargeable batteries,

SAFETY INFORMATION

Please read these instructions fully before operating or maintaining your machine

as they can overheat and break.

- Longer life and better performance can be obtained if the battery pack is charged when the air temperature is between 18°C and 24°C. Do not charge the battery pack in air temperatures below 0°C, or above 45°C. This is important as it can prevent serious damage to the battery pack.
- Charge only the battery pack of the same model provided by the manufacturer and those of models recommended by the manufacturer.

CHAIN SAW SAFETY WARNINGS

- Keep all parts of the body away from the saw chain when the chain saw is operating. Before you start the chain saw, make

sure the chain saw is not contacting anything. A moment of inattention while operating chain saws may cause entanglement of your clothing or body with the saw chain.

- Always hold the chain saw with your right hand on the rear handle and your left hand on the front handle. Holding the chain saw with a reversed hand configuration increases the risk of personal injury and should never be done.
- Wear safety glasses and hearing protection. Further protective equipment for head, hands, legs and feet is recommended. Adequate protective clothing will reduce personal injury by flying debris or accidental contact with the chain saw.
- Do not operate a chain saw in a tree. Operation of a chain saw while up in a

SAFETY INFORMATION

Please read these instructions fully before operating or maintaining your machine

tree may result in personal injury.

- Always keep proper footing and operate the chain saw only when standing on a fixed, secure and level surface. Slippery or unstable surfaces such as ladders may cause a loss of balance or control of the chain saw.
- When cutting a limb that is under tension be alert for spring back. When the tension in the wood fibers is released the spring loaded limb may strike the operator and/or throw the chain saw out of control.
- Use extreme caution when cutting brush and saplings. The slender material may catch the chain saw and be whipped toward you or pull you off balance.
- Carry the chain saw by the front handle with the chain saw switched off and away from your body. When transporting or storing the chain saw always fit the guide bar cover. Proper handling of the chain saw will reduce the likelihood of accidental contact with the moving chain saw.
- Follow instructions for lubricating, chain tensioning and changing accessories.
- Improperly tensioned or lubricated chain may either break or increase the chance for kickback.
- Keep handles dry, clean, and free from oil and grease. Greasy, oily handles are slippery causing loss of control.
- Cut wood only. Do not use chain saw for purposes not intended. For example: do not use chain saw for cutting plastic, masonry or non-wood building materials. Use of the chain saw for

SAFETY INFORMATION

Please read these instructions fully before operating or maintaining your machine

operations different than intended could result in a hazardous situation.

CAUSES AND OPERATOR PREVENTION OF KICKBACK:

Kickback may occur when the nose or tip of the guide bar touches an object, or when the wood closes in and pinches the chain saw in the cut.

Tip contact in some cases may cause a sudden reverse reaction, kicking the guide bar up and back towards the operator.

Pinching the chain saw along the top of the guide bar may push the guide bar rapidly back towards the operator.

Either of these reactions may cause you to lose control of the saw which could result in serious personal injury. Do not rely exclusively upon the safety devices built into your saw. As a chain saw user, you should take several

steps to keep your cutting jobs free from accident or injury.

Kickback is the result of tool misuse and/or incorrect operating procedures or conditions and can be avoided by taking proper precautions as given below:

- Do not overreach and do not cut above shoulder height. This helps prevent unintended tip contact and enables better control of the chain saw in unexpected situations.
- Only use replacement bars and chains specified by the manufacturer. Incorrect replacement bars and chains may cause chain breakage and/or kickback.
- Follow the manufacturer's sharpening and maintenance instructions for the chain saw. Decreasing the depth gauge height can lead to increased kickback.

SAFETY INFORMATION

Please read these instructions fully before operating or maintaining your machine



WARNING!

Residual risks

Even when the tool is used as prescribed it is not possible to eliminate all residual risk factors. The following hazards may arise in connection with the tool's construction and design:

- Damage to lungs if an effective dust mask is not worn.
- Damage to hearing if effective hearing protection is not worn.
- Health defects resulting from vibration emission if the appliance is being used over longer periods of time or not adequately managed and properly maintained.



WARNING!

This machine produces an electromagnetic field during operation. This field may under some circumstances interfere with active or passive medical implants. To reduce the risk of serious or fatal injury, we recommend persons with medical implants to consult their physician and the medical implant manufacturer before operating this machine.

SAFETY INFORMATION

Please read these instructions fully before operating or maintaining your machine

INTENDED USE

This cordless chainsaw (hereinafter product “power tool”) is designed for cutting wood only. The product is not designed for any other types of application (e. g. cutting of brickwork, plastic or food).

The product is to be used by adults. Children under the age of 16 may not use the tool except under supervision.

Any other use or modification of the product are considered improper use and can result in hazards such as death, life-threatening injuries and damage. The manufacturer is not liable for any damages caused by improper use. The product is not intended for commercial use or for any other use.

Do not use and store the power tool in rain or wet

conditions.

Observe all applicable local safety regulations, standards and ordinances. The use of noise emitting power tools may be restricted to certain times by national or local regulations.

BOX CONTENTS

PARTS

- | | | | |
|---|--------------------------------|----|---------------------|
| 1 | Rear handle | 10 | Spiked bumper |
| 2 | Oil tank cap | 11 | Front handle |
| 3 | Front guard / chain brake | 12 | Motor housing |
| 4 | Guide bar | 13 | On / off switch |
| 5 | Saw chain | 14 | Lock-off button |
| 6 | Lock knob / Chain tension knob | 15 | Oil level indicator |
| 7 | Drive cover | 16 | Guide bar cover |
| 8 | 100ml lubrication oil | 17 | Battery pack X2 |
| 9 | Rear guard | 18 | Charger |

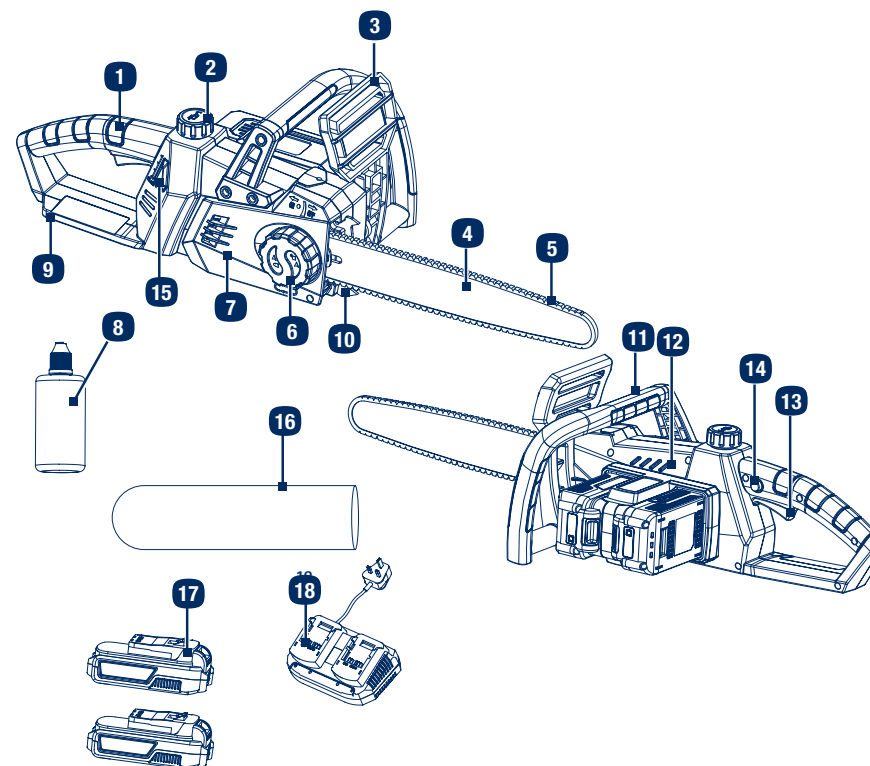

If there are any parts missing, please call the customer helpline on 0345 605 2067

ASSEMBLY

1 Unpacking

- i. Unpack all parts and lay them on a flat and stable surface.
- ii. Remove all packing materials and shipping devices if applicable.
- iii. Make sure the delivery contents are complete and free of any damage. If you find that parts are missing or show damage do not use the product but contact the aftersales service within 28 days of purchase. Using an incomplete or damaged product represents a hazard to people and property.
- iv. Ensure that you have all the accessories and tools needed for assembly and operation. This also includes suitable personal protective equipment.

2 Checking the chain tension

Proper tension of the chain saw is extremely important and must be checked before starting, as well as during, any cutting operation. Taking the time to make needed adjustments to the chain saw will result in improved cutting performance and prolonged chain life.

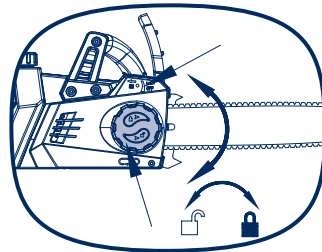

ASSEMBLY



NOTE: A new chain and bar will need readjusting after as few as 5 cuts. This is normal during the break-in period, and the interval between future adjustments will lengthen quickly.



CAUTION: If a chain is TOO LOOSE or TOO TIGHT, the bar chain and saw bearings will wear more rapidly. Study for information concerning correct cold tension (A), correct warm tension (B), and as a guide for when chain saw needs adjusting (C).

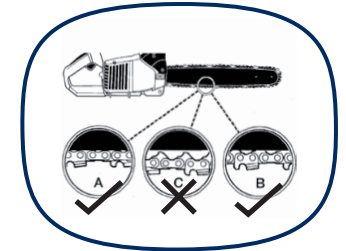

3 Filling oil tank



WARNING! The product is not filled with oil. It is essential to fill the product with oil before using it! Never operate the product without chain oil or with an empty oil tank, as this will result in extensive damage to the product!

- i. Park the chainsaw on a level surface.
- ii. Clean the area around the oil tank cap (A) and then open.
- iii. Fill the oil tank with saw chain oil. Make sure that no dirt gets into the oil tank, so that the oil nozzle does not clog up.
- iv. Close oil tank cover (A).

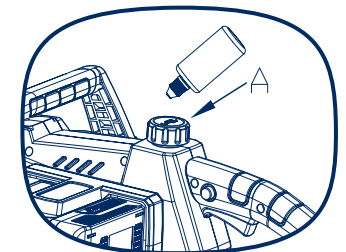

ASSEMBLY

4 Installing or removing battery pack

- i. Hold the tool and the battery pack firmly when installing or removing the battery pack. Failure to hold the tool and the battery pack firmly may cause them to slip off your hands and result in damage to the tool and battery pack, potentially causing a personal injury.
- ii. Always switch off the tool before installing or removing the battery pack.
- iii. To remove battery pack, press the release button, and pull out. To install the battery pack, align the tongue on the battery pack with the groove in the housing and slip it into place. Always insert it all the way until it locks in place with a little click. If not, it may accidentally fall out of the tool, causing injury to you or someone around you.

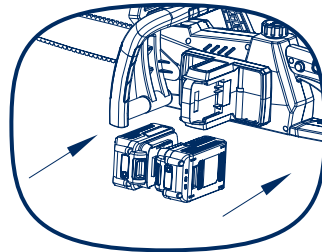

NOTE: Do not use force when installing the battery pack. If the battery pack does not slide in easily, it is not being inserted correctly.



WARNING : Verify that the switch is in the OFF position before inserting or removing the battery pack.



WARNING : Verify that the battery pack is removed and the switch is in the OFF position before inspecting, adjusting or performing maintenance on any part of the chain saw.



WARNING : Read, understand and follow the instructions contained in the section entitled charging procedure.

ASSEMBLY

5 Checking battery capacity

Press the battery capacity level button to check the charging level of the battery pack. The status / remaining charge will be shown on the battery charging level indication light.

3 Green LEDs continuously lit	Battery pack fully charged
2 Green LEDs continuously lit	Battery pack 65% charged
1 Green LED continuously lit	Battery pack 35% charged
No LED lit	Battery is dead and needs to be charged

Charge the battery pack before operating when it is at medium or low battery charging level.

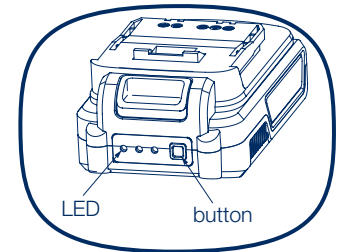

6 Charging the battery pack



NOTE : The battery pack comes partly charged. Charge the battery pack prior to first use, ideally at least 60 minutes.

- . Always pull out the plug of charger from the mains before removing or connecting the battery pack to the charger.
- . Never charge the battery pack when the ambient temperature is below 5 °C or above 40°C.
- . Never recharge a battery pack again immediately after rapid charging. This could overcharge the battery pack, thus reducing the lifespan of the battery pack and charger.
- . Rest the charger for at least 15 minutes between continuously charging sessions.
- . If no battery pack is inserted into the charger and the charger is connected to mains, the charging status LED shows red.

ASSEMBLY

- i. Connect the battery pack to the battery charger.
- ii. Insert the mains plug into the socket. The green charging status LED light will flash. Once the battery pack is completely charged, the green charging status LED is lit continuously, indicating that the charging process is complete.
- iii. Disconnect the charger from the mains and remove the battery pack from the charger.
- iv. Attach the battery pack back to the product.

Charging status LEDs

RED LED turn on	Charger ready
green LED flash	Battery pack charging
Green LED continuously lit	Battery pack fully charged
Red and green LEDs flashing	Battery pack defect
Red and green LEDs continuously lit	Battery pack too cold or warm

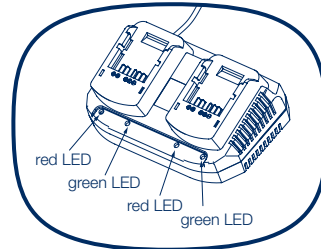

OPERATION

STARTING THE CHAINSAW

Installing the battery pack

- i. Keep the battery pack in line with the holder on the device.
- ii. Push it forward until it reaches the bottom. Before starting, make sure the battery pack is firmly locked in place.

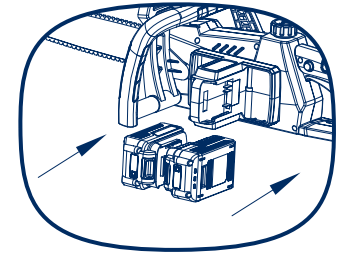

Removing the battery from the product

- i. Press the battery pack release button (A) downward.
- ii. Pull the battery pack towards the operator, then remove it.

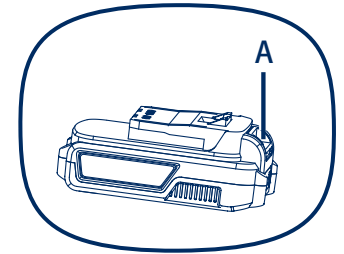

OPERATION



Attention! The battery cannot be charged immediately after use, it should be left to cool down for a period of time. The LED lights on the charger switching from green to red, meaning the battery can be charged.

Switching on/off



NOTE: Hold the chain saw away from yourself using both hands. Stand in a secure and stable position.

- i. Push the safety switch (14) forward and press the on/off switch (13) to turn the product on.
- ii. Release the on/off switch (13) to turn the product off.

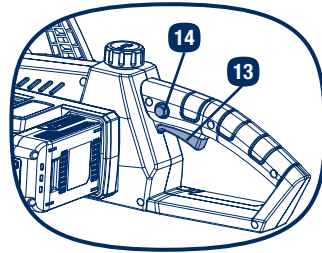

Check the oil supply



NOTE! With the chainsaw fully assembled and adjusted it is important to check the chain oil supply is dispensing adequate lubrication.

After switching on, run the chain and see if chain oil is being dispensed as shown.

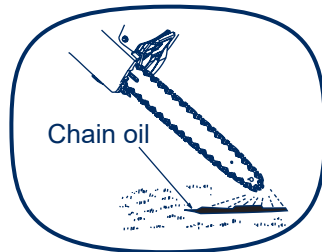

OPERATION

Chain Tension

1. Loosen the lock knob B before adjusting the chain.
2. Turn the chain tension knob until slack is out of chain.
3. Whilst wearing protective gloves, pull down on the chain to check the chain tension.
4. Do not use excessive tension on the chain. Doing this will cause excessive wear and will reduce the life of the guide bar and chain. Using excessive tension will also reduce the amount of cuts per battery charge.
5. Only when the tension on the chain is right, then tighten the tension wheel firmly.

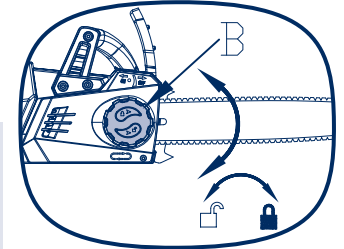
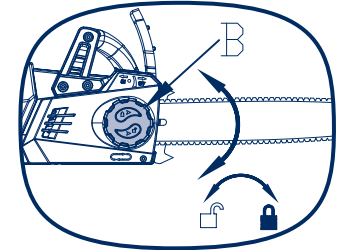

Important!

It is very important to adjust the chain tension if the chain is loose. Check if the chain is loose every 10mins.



NOTE! When tensioned correctly it should be possible to pull one full chain link free of the bar channel with ease.

- A new chain will expand its length during the first period of use. Check and re-adjust the tension frequently as a loose chain can easily derail or cause rapid wear of itself and the chain bar.



CAUTION! If the saw chain is TOO LOOSE or TOO TIGHT the V-drive wheel, chain bar, chain and crank shaft bearing will suffer premature wear. Right Fig. shows the correct tension A (when cold) and tension B (when warm). Fig. C shows a chain that is too loose.

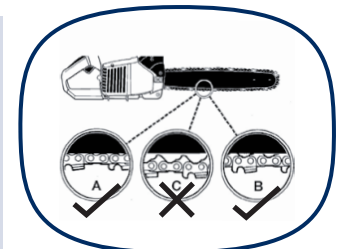

OPERATION

Chain brake / hand guard



CAUTION: A loose chain can jump off the bar while you are cutting, as well as wear the bar and chain. A chain that is too tight can damage the saw. Either way, if a chain is too loose or too tight, it could cause serious personal injury.

This chain saw is equipped with a Chain brake/Hand guard which stops a moving chain in milliseconds, helping to reduce the hazard of kickback, a fast upward motion of the guide bar which occurs when the saw chain at the nose of the bar accidentally strikes an object or is pinched in the cut. The Hand Guard also protects your left hand in the event it slips off the front handle.

The chain brake is a safety feature which is activated if pressure is applied against the guard or when, in the event of kickback, the operator's hand strikes the lever. When the chain brake is activated, chain movement abruptly stops and the power supply to the motor is immediately cut off.

The purpose of the chain brake is to reduce the possibility of injury due to kickback. The chain brake cannot, however, provide the measure of intended protection if the saw is carelessly operated. The chain brake is disengaged (chain can move) when the brake is pulled back and locked. This is the normal running position. The chain brake is engaged (chain cannot move) when the brake is in the forward position.



CAUTION: NOTE: The motor will not start if the chain brake is in the engaged position.



Brake is engaged and the product can not be started or run.



Brake is disengaged and the product can be operated.



CAUTION: NOTE: The motor will not start if the chain brake is in the engaged position.

OPERATION

Chain brake test

Before cutting with your saw, the chain brake should be tested as follows:

- A. Make sure the chain brake is disengaged.
- B. Place the saw on a firm, flat, dry surface that is clear of any debris. Do not let the saw come in contact with any objects.
- C. Instal of the battery pack.
- D. Grasp the front handle (not the Chain Brake / Hand Guard Lever) with your left hand. Thumb and fingers should encircle the handle.
- E. Grasp the rear handle with your right hand .Thumb and fingers should encircle the handle.
- F. Depress the Lock-off button with your right thumb. Squeeze the trigger with your index finger.
- G. While the motor is running, activate the chain brake by rolling your left hand forward against the lever.
- H. Chain and motor should stop abruptly.



WARNING: If the chain and motor fail to stop when the chain brake is engaged, take the saw to the nearest professional Service Center. Do not use the saw if the chain brake is not in proper working order.

Cutting

Felling

Felling is the term for cutting down a tree. Small trees up to 12-15cm in diameter are usually cut in a single cut.

Limbing

Limbing a tree is the process of removing the branches from a fallen tree. Do not remove supporting limbs (A) until after the log is bucked (cut) into lengths. Branches under tension should be cut from the bottom up to avoid binding the chain saw.

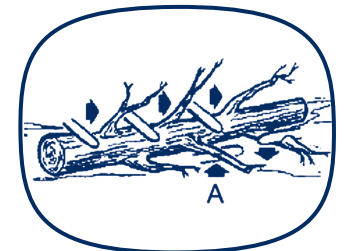

OPERATION

Bucking

Bucking is cutting a fallen log into lengths. Make sure you have a good footing and stand uphill of the log when cutting on sloping ground. If possible, the log should be supported so that the end to be cut off is not resting on the ground. If the log is supported at both ends and you must cut in the middle, make a downward cut halfway through the log and then make the undercut. This will prevent the log from pinching the bar and chain. Be careful that the chain does not cut into the ground when bucking as this causes rapid dulling of the chain.

When bucking on a slope, always stand on the uphill side.

1. Log supported along entire length: Cut from top (over buck), being careful to avoid cutting into the ground.

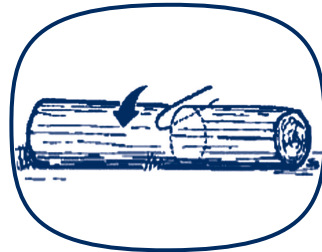

2. Log supported on 1 end: First, cut from the bottom (under buck) 1/3 diameter of log to avoid splintering. Second, cut from above (over buck) to meet the first cut and avoid pinching.

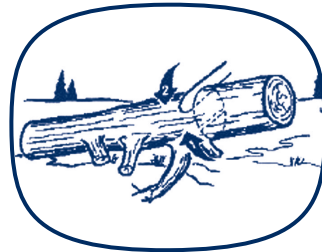

3. Log supported on both ends: First, over buck 1/3 diameter of log to avoid splintering. Second, under buck to meet first cut and avoid pinching.

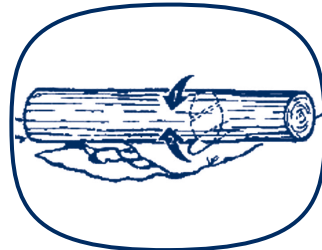

OPERATION



NOTE: The best way to hold a log while bucking is to use a saw horse. When this is not possible, the log should be raised and supported by the limb stumps or by using supporting logs. Be sure the log being cut is securely supported.

For personal safety and ease of cutting, the correct position for vertical bucking is essential.



VERTICAL CUTTING:

- A. Hold the saw firmly with both hands and keep the saw to the right of your body while cutting.
- B. Keep the left arm as straight as possible.
- C. Keep weight on both feet.

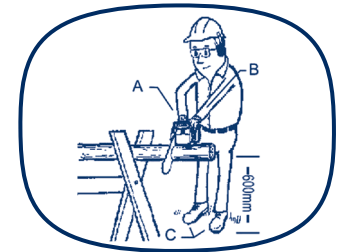

CAUTION: While the saw is cutting, be sure the chain and bar are being properly lubricated.

MAINTENANCE

Preventative maintenance

CAUTION: Place switch in OFF position and remove the battery pack before the appliance is serviced, cleaned, or maintenance is performed.

1. Keep the air intake clean and air vents free of debris to avoid overheating the motor.
2. Clean with a damp sponge and mild soap. Do not squirt with a water hose or douse with water or other liquids.
3. Inspect the saws chain for proper tension before each use and frequently during cutting.
4. Clean the guide bar and bar pad to ensure free path for oil.
5. Turn the bar over after each use to achieve even wear.

NOTE: No motor lubrication is necessary. The motor is equipped with lifetime lubricated bearings.

NOTE: If the chainsaw do not operate, turn switch to OFF position and remove the battery pack first. Do not attempt to repair it yourself.

Bar/chain maintenance

WARNING: Before servicing the saw, make sure that the battery pack is removed.

Proper maintenance of the rail, as explained here, is essential to keep your saw in good working order.

SPROCKET TIP LUBRICATION:

(For unite supplied with sprocket tip guide bars only)

WARNING: Failure to lubricate the reversing star will result in poor performance and jamming, and will void the warranty.

MAINTENANCE

CAUTION: Failure to lubricate the guide bar sprocket tip as explained below will result in poor performance and seizure, voiding the manufacturer's warranty.

Lubrication of the sprocket tip is recommended after each saw use. Always thoroughly clean the guide bar sprocket tip before lubrication.

TO LUBRICATE SPROCKET TIP:

WARNING: Wear heavy duty work gloves when performing this application to reduce risk of personal injury.

1. Remove the battery pack from the chain saw.

NOTE: It is not necessary to remove the chain saw to lubricate the guide bar sprocket tip. Lubrication can be done on the Job.

2. Clean the guide bar sprocket tip.
3. Using disposable Lube gunp insert the needle nose into the lubrication hole and inject grease until it appears at the outside edge of the sprocket tip.
4. Turn the chain by hand. Repeat this procedure until the entire deflection star is greased.

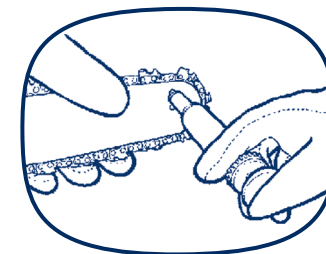

MAINTENANCE

Guide bar maintenance

Most guide bar problems can be prevented merely by keeping the chain saw well maintained.

Incorrect filing and non-uniform cutter and depth gauge settings cause most guide bar problems, primarily resulting in uneven bar wear. As the bar wears unevenly the rails widen, which may cause chain clatter and difficulty in making straight cuts.

Insufficient guide bar lubrication and operating the saw with a chain that is TOO TIGHT will contribute to rapid bar wear (see Section CHAIN MAINTENANCE INSTRUCTIONS).

To help minimize bar wear, the following guide bar maintenance is recommended.

GUIDE BAR - The bar should be reversed every 8 working hours to ensure uniform wear. Keep the bar groove and lubrication hole clean using the bar groove cleaner supplied optional.

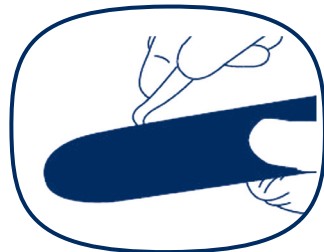

MAINTENANCE

BAR WEAR - Turn guide bar frequently at regular intervals (for example, after 8 hours of use), to ensure even wear on top and bottom of the bar.

BAR GROOVES - Bar grooves (or rails which support and carry the chain) should be cleaned if the saw has been heavily used or if the saw chain appears dirty. Rails should always be cleaned every time the saw chain is removed.

OIL PASSAGES - Oil passages at bar pad should be cleaned to ensure proper lubrication of the bar and chain during operation. This can be done using a soft wire small enough to insert into the oil discharge hole.



NOTE: The condition of the oil passages can be easily checked. If the passages are clean the chain will automatically give off a spray of oil within seconds of starting the saw. Your saw is equipped with an automatic oiler system.

What is a low kickback saw chain?

Lowkickback saw chain is a chain which has met the kickback performance requirements of ISO 9518. By keeping the chain brake and saw chain in good working condition and correctly serviced as recommended in this manual, you will be able to maintain the safety system of your chain saw over the life of the product.



WARNING: Never remove, modify or make inoperative any safety device furnished with your unit. The Chain Braks/Hand Guard and low-kickback saw chain are major safety features provided for your protection.



WARNING: Always wear heavy duty protection work gloves and disconnect the battery pack when working on the saw chain.

MAINTENANCE

Chain Maintenance

CHAIN TENSION:

Check the chain tension frequently and adjust as often as necessary to keep the chain snug on the bar, but loose enough to be pulled around by hand. (See Section chainsaw TENSION ADJUSTMENT)

BREAKING IN A NEW SAW CHAIN:

A new chain and bar will need readjusting after as few as 5 cuts. This is normal during the break-in period, and the interval between future adjustments will begin to lengthen quickly.

Over a period of time, however, the moving parts of the saw chain will become worn, resulting in what is called CHAIN STRETCH. This is normal. When it is no longer possible to obtain correct chain tension adjustment, a link will have to be removed to shorten the chain.



WARNING: Never have more than 3 links removed from a loop of chains as this could cause damage to the sprocket.

CHAIN LUBRICATION:

Always make sure the automatic oiler system is working properly. Keep the oil tank filled with Chain, Bar and Sprocket Oil.

Adequate lubrication of the bar and chain during cutting operations is essential to minimize friction with the guide bar.

Never starve the bar and chain of lubricating oil. Running the saw dry or with too little oil will decrease rapid cutting efficiency, shorten saw chain life, cause rapid dulling of the chain, and lead to excessive wear of the bar from overheating. Too little oil is evidenced by smoke or bar discoloration.

MAINTENANCE

Replace the chain

- i. Remove the clamp knob (6) and the chain cover
- ii. Fit the chain around the bar ensuring that the direction of the chain is as depicted in the picture on the bar. Fit the chain on the sprocket.
- iii. Adjust the tension to ensure that there is not too much slack in the chain. Pay attention to the correct direction of the saw chain.
- iv. Fit the chain cover to the power unit. While lifting the tip of guide bar, tighten the bar knob securely (clockwise). Hand tighten only!

NOTE! A new chain will expand its length during the first period of use. Check and re-adjust the tension frequently as a loose chain can easily derail or cause rapid wear of itself and the chain bar. If the saw chain is TOO LOOSE or TOO TAUT, the Vdrive wheel, the chain bar, the chain and the crank shaft bearing will suffer premature wear.

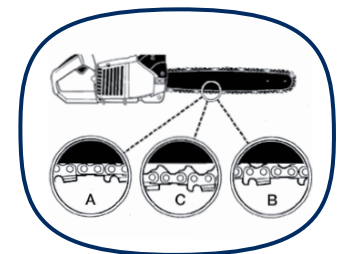
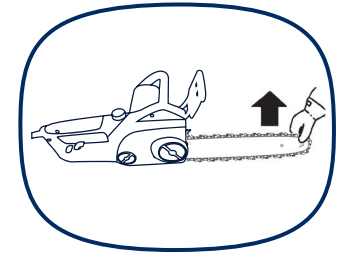
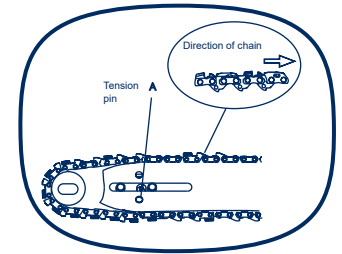

MAINTENANCE

CHAIN AND BAR LUBRICATION

Adequate lubrication of the chain saw during cutting operations is essential to minimize friction with the guide bar. Your chain saw is equipped with an automatic oiler system. The oiler automatically delivers the proper amount of oil to the bar and chain. The oil tank level can be checked in the oil inspection window (A) provided on the right side of the saw. The tank is full when oil is at the top of the slot.

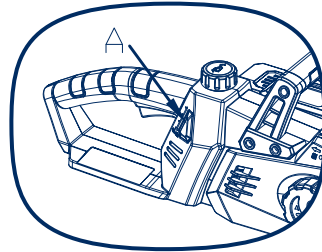

! **CAUTION:** Never starve the bar and chain of lubrication oil. Running the saw DRY or with TOO LITTLE OIL will decrease cutting efficiency, shorten chain saw life, and cause rapid dulling of the chain and excessive wear of the bar from overheating. Too little is evidenced by smoke or bar discoloration.

! **NOTE:** The chain saw stretches during use, particularly when it is new, and occasional adjustment will be needed. A new chain requires more frequent adjustment during the break-in period. This is normal. See Section chain saw Tension Adjustment instructions.

DISPOSAL

To help protect the environment, please dispose of the product properly when it has reached the end of its useful life and not in the household waste. Information on collection points and their opening hours can be obtained from your local authority. Faulty or used batteries / rechargeable batteries must be recycled in accordance with Directive 2006/66/EC and its amendments. Please return the batteries / rechargeable batteries and / or the product to the available collection points.





TROUBLESHOOTING

Problem	Possible cause	Solution
Product does not start	<ul style="list-style-type: none"> Battery pack not properly attached Battery pack discharged Battery pack damaged Other electrical defect to the product 	<ul style="list-style-type: none"> Attach properly Remove and charge the battery pack Check by a specialist electrician Check by a specialist electrician
Product does not reach full power	<ul style="list-style-type: none"> Battery pack capacity too low Air vents are blocked 	<ul style="list-style-type: none"> Remove and charge the battery pack Clean the air vents
Unsatisfactory result	<ul style="list-style-type: none"> Accessory is worn Accessory not suitable for intended operation 	<ul style="list-style-type: none"> Replace with a new one Use suitable accessory
Product suddenly stops	<ul style="list-style-type: none"> Product overloaded Battery pack discharged Battery pack too hot 	<ul style="list-style-type: none"> Remove the product from the workpiece and switch it on again Remove and charge the battery pack Remove the battery pack and let it cool down
Excessive vibration or noise	<ul style="list-style-type: none"> Accessory is dull / damaged Bolts/nuts are loose 	<ul style="list-style-type: none"> Replace with a new one Tighten bolts/nuts

TECHNICAL DATA

Model No.	S3635CC
Nominal voltage of product with battery	2x18V 2.0Ah Li-ion
Chain speed	8.5m/s
Bar length	350mm(14")
Bar/chain code	Oregon, 90PX052X / 144MLEA041
Net weight	3.8kg
Oil tank capacity	150ml
Vibrations	Rear handle: 4.92m/s ² , K=1.5m/s ² Front handle: 2.57m/s ² , K=1.5m/s ²

Charger	
Model No.	B0Q-SP07-2040ZB
Input voltage & power	220-240V AC, 50/60Hz 120W
Output voltage & current	21V  , 4A

Battery pack	
Model No.	B0P-SP07-18-D(5INR19/65)
Battery voltage	18V  , Li-ion
Battery capacity	2.0Ah

Part Number	Accessories
1970ZA0026	Bar
1970ZA0027	Chain
S3635cc-01	Battery
S3635cc-02	Charger

TECHNICAL DATA

Noise emission value:

Noise measurement value determined in accordance with EN 60745. The A-rated noiselevel of the power tool is typically as follows:

Sound pressure level L_{PA} : 81.9dB(A)

Uncertainty $k= 3$ dB(A)

Sound power level L_{WA} : 92.8dB(A)

Uncertainty $k= 2.6$ dB(A)

Guaranteed sound power level L_{WA} : 96dB(A)

The vibration level varies in accordance with the use of the power tool and may be higher than the value specified in these instructions in some cases. There is a risk of underestimation of the vibration load if the power tool is used regularly in this manner. Try to keep the vibration loads as low as possible. Measures to reduce the vibration load are, e.g. wearing gloves and limiting the working time. Where in all states of operation must be included (e. g. times when the power tool is switched off and times where the power tool is switched on but running without load).



NOTE

The vibration level specified in these instructions has been measured in accordance with a standardised measuring procedure specified in EN 607 45 and can be used to make equipment comparisons. The specified vibration emission value can also be used to make an initial exposure estimate.

WARRANTY

If your device develops a fault, please don't hesitate to contact our customer service department on 0345 605 2067, the majority of problems can be solved directly on the phone.

1. These warranty terms cover additional warranty rights and do not affect your statutory warranty rights. All our products are covered by a 3 year manufacturer warranty.
2. Claims must be accompanied by proof of purchase. This must be in the form of a sales receipt or bank statement and must show that the product has been purchased within the warranty period as described under point 1, from the retailer that it was originally bought from. Please keep your receipt safe or staple it to the back of this manual for future reference.
3. Our warranty covers problems caused by material or manufacturing defects, and will result in the repair of these defects or replacement of the device with a like for like or similar article.
4. Our devices have not been designed for commercial, trade or industrial applications, any signs of use of the equipment in these application or equivalent activities, invalidates the warranty.
5. The following are also excluded from our warranty:
 - A. Faults due to accidents, customer misuse or unauthorised repairs
 - B. Consumable parts such as batteries, chargers, blades, quick release locks, and other accessories that are compatible with the product.
 - C. Failure due to lack of routine maintenance.
 - D. Failure as a result of not using the equipment in accordance with the manual and safety instructions
 - E. The adjustment of cables, chargers, or battery packs

Warranty claims should be submitted before the end of the warranty period, see point 1, but a paid service exists for repairs commissioned after this period. The original warranty period remains applicable to the device even if repairs are carried out or parts are replaced.

In such cases, the work performed or parts fitted will not result in an extension of the warranty period, and no new warranty will become active for the work performed or parts fitted.

If you have any problems or questions concerning your garden power tool, please contact our after sales service at 0345 605 2067.