

X50i
X60i
X80i
X100i



GB **ROBOTIC MOWER**
Installation Guide

DE **MÄHROBOTER**
Installationsanleitung

FR **ROBOT-TONDEUSE**
Guide d'installation

NL **ROBOTMAAIER**
Gebruiksaanwijzing

CZ **ROBOSEKAČKA**
Průvodce instalací

PL **ROBOT KOSZĄCY**
Instrukcja instalacji

Nov. 2018
V1.0

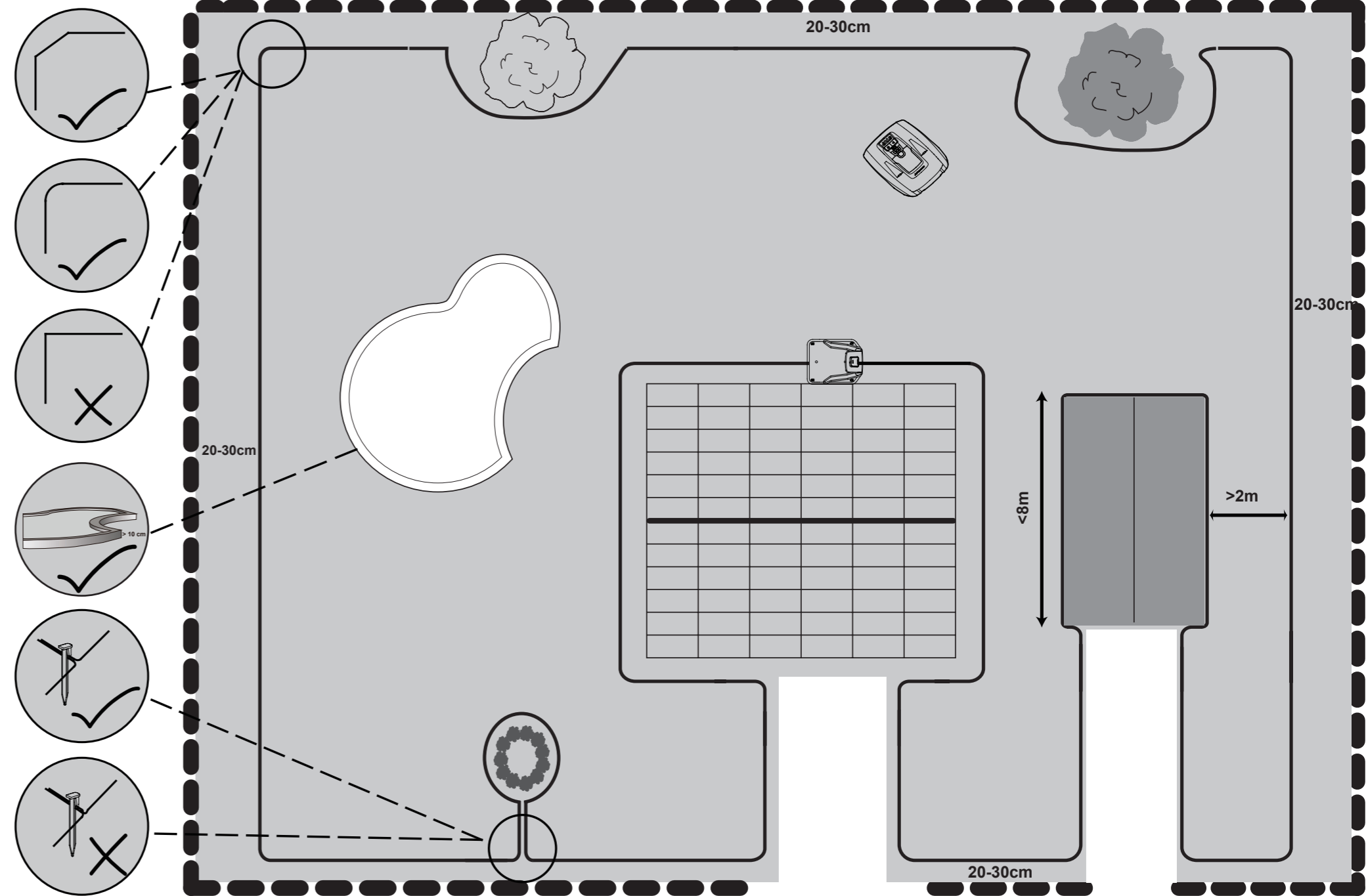

CONTENT

- Description of product1
- Installation 2
- Operation10
- Technical data13
- Maintenance and storage14
- Troubleshooting16
- APP17

Description of product

1. STOP button
2. Ultrasonic sensor
3. Charging inlet
4. Rear wheel
5. Height adjustment dial
6. Control panel
7. Blade plate
8. Carry handle
9. Power switch button

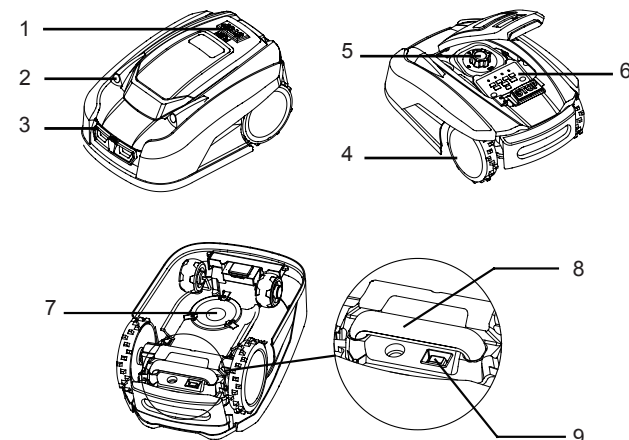

Scope of delivery

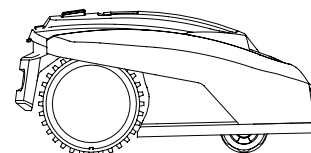

Robotic Mower

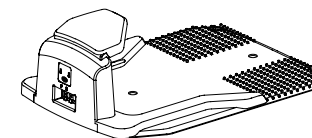

Docking station



Extension cord



Switching Power Supply



Wire pegs

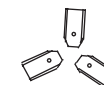

Spare blades



Connectors



Measurement ruler

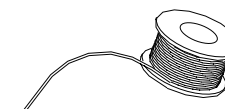

Boundary wire

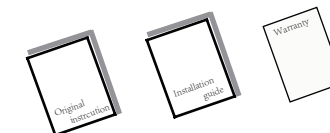

Manuals

Installation

Installation Guide

This chapter explains how to install the Robotic Mower. Please read this completely before you start the installation.

Introduction

We recommend creating a draft of your lawn, including all obstacles and how these should be protected. This makes it easier to find a good position for the docking station and how to correctly place the boundary wire around your garden perimeter protecting bushes, flower beds etc. You will also need some tools, like a hammer and wire cutters, pliers or scissors.

Cutting limitations

The Robotic Mower is equipped with collision sensors. These will detect any rigid and fixed obstacles higher than 100 mm, such as walls, fences and garden furniture.

When triggered, the Robotic Mower will stop, reverse backwards and then continue mowing in a different direction. Still, protecting the obstacles running the boundary wire accordingly is the recommended long-term solution.

Trees

The Robotic Mower treats trees as common obstacles, but if the roots of the tree are exposed and lower than 100mm, this area should be excluded using boundary wire in order to protect the tree root, cutting blades or rear wheels from damage.

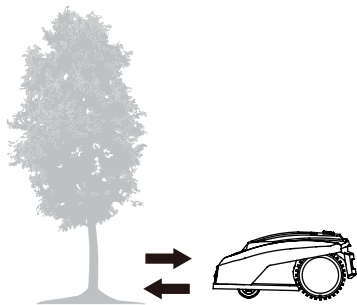

Stones

We recommend clearing the lawn of small (less than 100 mm high) rocks and stones and any stones with a round or sloped edge. The Robotic Mower might try and climb such rocks instead of recognising them as a barrier. A Robotic Mower getting stuck on such a stone requires user intervention to restart mowing. Contact with stones can result in damage to the blades.

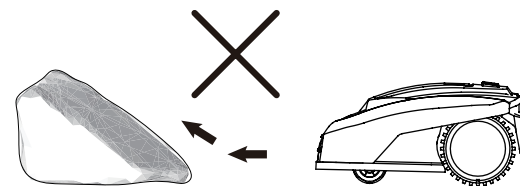

Slopes

The Robotic Mower can navigate slopes up to a maximum of 40% incline or decline.

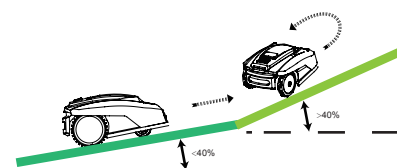

Paths, Driveways and Roads

If an elevated driveway crosses your lawn, better keep it outside the boundary wire. Please allow a safety distance of 40 cm between driveway and boundary wire.



If the driveway and lawn are at the same level, feel free to use the boundary wire to create a corridor. This allows your Robotic Mower to cross the driveway and reach the opposite lawn.

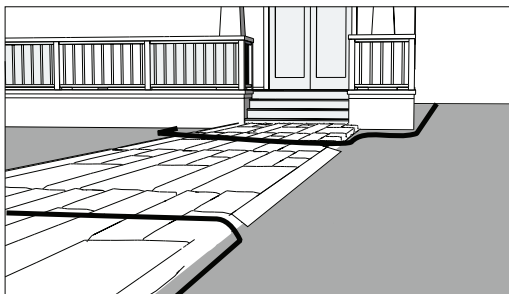

Uneven lawn surfaces

Uneven lawn areas may cause the blades to touch the ground. We recommend leveling the lawn before using your Robotic Mower or excluding uneven areas with the boundary wire.

Placing the docking station

Locate the best position for your docking station. Be aware that it needs a permanent connection to the mains, so take into account the location of the nearest power outlet.

To ensure the Robotic Mower can return to the docking station smoothly, leave 2m of straight wire to the front of the docking station and 50cm to the side facing the cutting area. Use a shaded location for the docking station, as a lower temperature while charging is beneficial to the battery. Important: Place the docking station on an even, flat surface away from ponds, pools or stairs.

We recommend suitable protection from the elements, for example a robot port or garage.

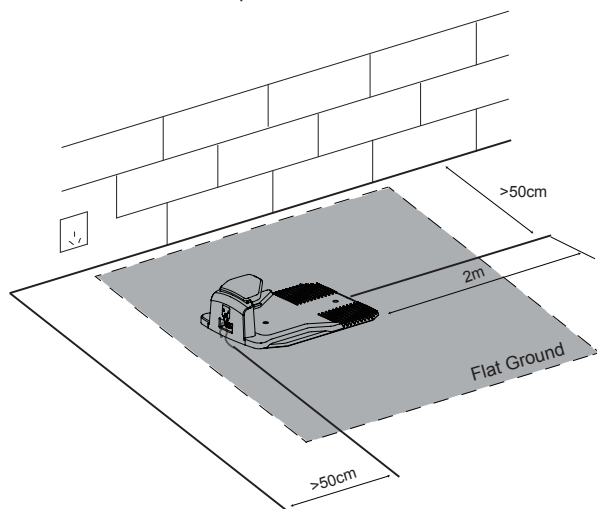

Do not place the docking station too close to a slope, such as at the top of a hill or the bottom of a furrow. Avoid left and right inclination in excess of 5 degrees.

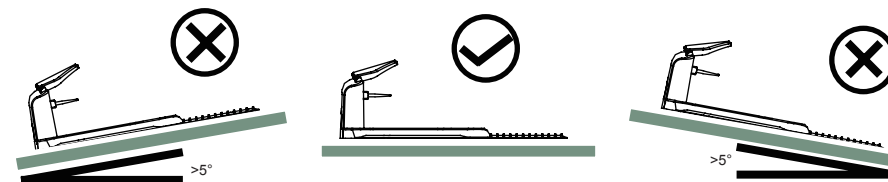

If your lawn has a soft or uneven surface, we recommend fortifying the area around the docking station with a grass protection mesh. Otherwise, the repeated stress of the rear wheels can damage the turf.

Once the position of the docking station is confirmed and mains electrical connection is laid out, please do not connect to main power yet. Finish all boundary layout work before connecting the docking station to the power supply.

Pegging your boundary wire

We strongly recommend mowing the lawn to 60 mm or less before laying out the boundary wire. Burying the boundary wire is entirely optional. Still, the closer to the ground you lay out the boundary wire, the lower the chance of tripping over it or damaging it when mowing the lawn. Use the included ruler to ensure the required 20-30 cm distance between wire and obstacles.

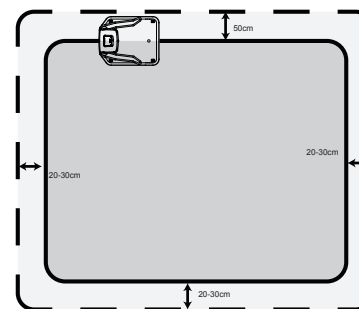

The recommended distance between two pegs is about 80 cm in straight lines, and less in tight curves. Note that the pegs' hook and wire slit always faces the outside of the boundary.

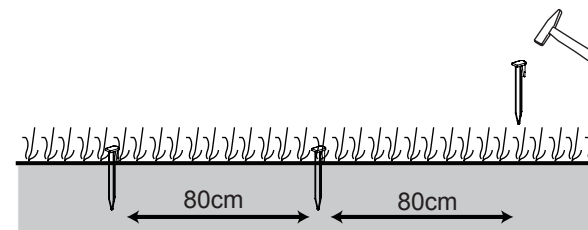

When first planting the pegs, do not drive them fully into the ground. Use a light hammer to drive them in a little bit. Also locate the fixing pegs and lay each one on the lawn at approximately the correct distance from lawn edges (20-30cm) and obstacles.

Flowerbeds

Use the boundary wire to exclude any flowerbeds from the cutting area. There are two options for the two lengths of boundary wire running between the flowerbed and the outer boundary:

1) Keep the distance between the parallel wires above 10 cm. This way, the Robotic Mower will recognise the boundary wire as an ordinary obstacle. When cutting, it will "bounce" off it as usual. When following the boundary wire back to the docking station, it will take the detour around the flower bed.

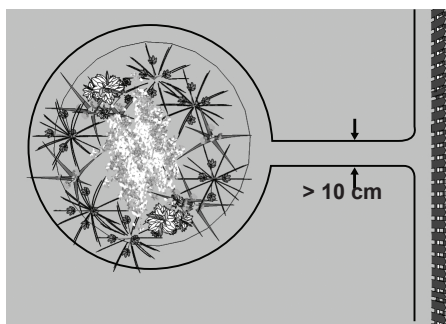

2) Alternatively, keep the distance between the two parallel wires below 5 mm. Do not cross the wires - **see below**. This way, the Robotic Mower will not recognise the wires and travel across them unhindered. This option requires placing an obstacle on the boundary wire around the flowerbed. Place the obstacle, e. g. a large rock or pole, near **position A** indicated on the below illustration. The obstacle must be surrounded by a flat area of about 1 m x 1 m, without any slopes. This obstacle will allow the machine to exit the circle.

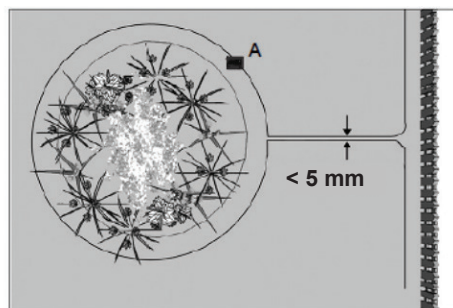

Ponds and Pools

While the Robotic Mower is protected against rain and spray water, being submerged is likely to cause severe damage to the electronic parts.

Therefore, it is imperative to exclude any pools from the cutting area. For added safety, we recommend placing a fence around the pool.

Inventory and garage

If you have created a boundary corridor inside your working area, the corridor should be at least 2 m wide and a max length of 8 m.

If a corridor is too narrow or too long, the Robotic Mower might not be able to navigate it from one end to the other.

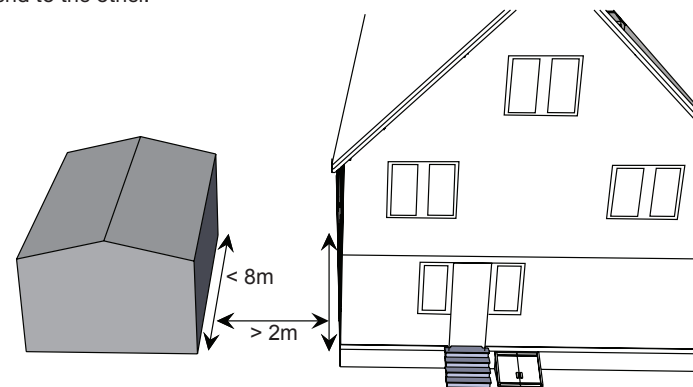

Connect the docking station to the boundary wire

Place the docking station on the end of the boundary wire so that the wire runs lengthwise below the middle of the docking station. Connect that end to the left (black) connector marked "F" (front). Connect the other end to the right (red) connector marked "B" (back).

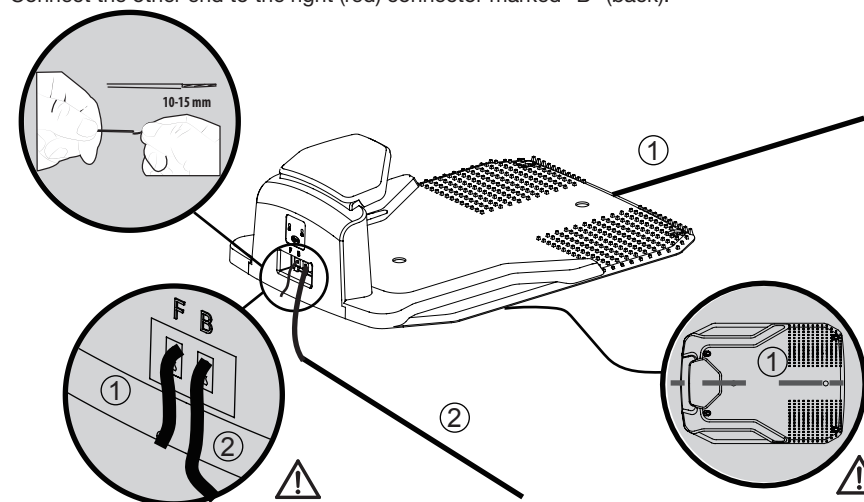

Once the blue LED confirms all is OK, test the Robotic Mower's function. Check the LED regularly to ensure fixing the boundary wire has not affected the connection and signal shows S1 on the docking station. Then place the Robotic Mower in the working area, a few metres beside the docking station. Set the main power switch to "ON".

Press the buttons **STOP** and , a few seconds later, the Robotic Mower should automatically return to the docking station by locating and following the boundary wire in anti-clockwise direction. If Robotic Mower fails to dock correctly, move the docking station to a more suitable position.

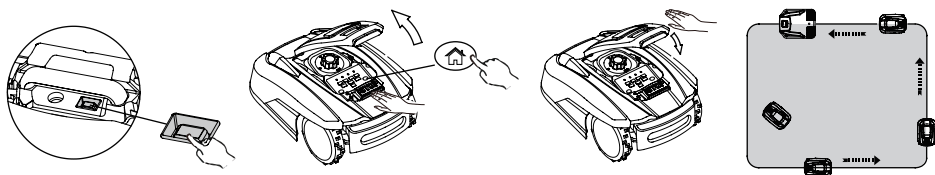

Once the device has docked, the symbol will start flashing. This indicates that the battery is charging correctly.

After initial installation, the Robotic Mower will remain in the docking station until the battery is fully charged.

Successful docking and charging indicates that you have found a suitable position for the docking station. You should now drive fixing pegs into ground fully. Take care not to damage or kink the surplus wire stored under the docking station.

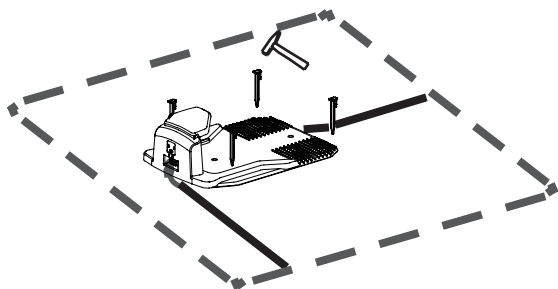

Signal selection

There are two signals which can be selected, S1 (blue indicator) and S2 (red indicator). Make sure your Robotic Mower and docking station are using the same signal.

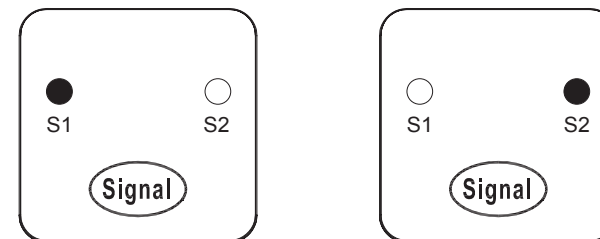

If your neighbour is using the same, will need to keep a distance of 0.5m between you and your neighbour's boundary wires to prevent the two devices interfering with each other. Ensure to position your docking station at least 10m away from your neighbour's boundary wires and that both products are using different signals. Please refer to section "Signal setting" in order to select signal S1 or S2 for your installation.

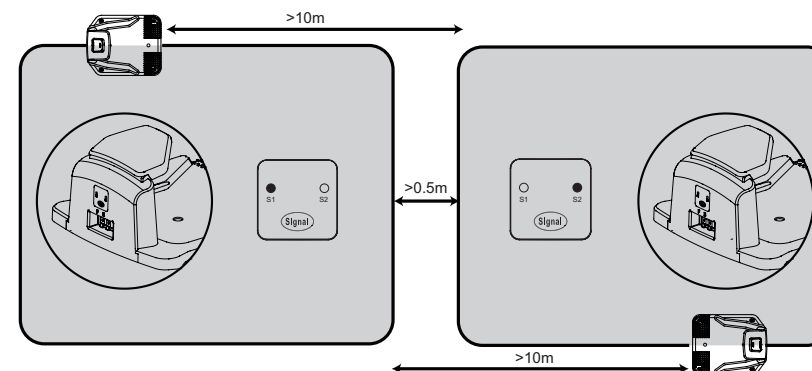

Operation

Control panel

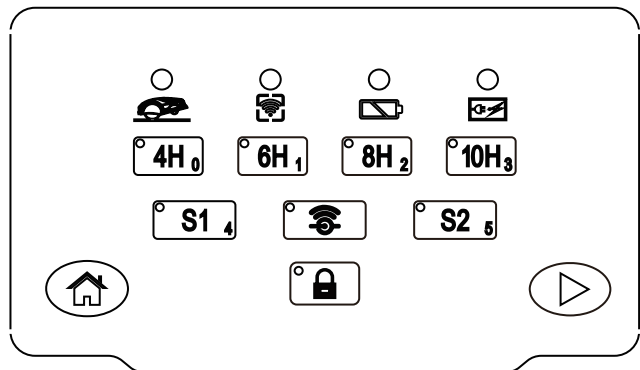

Indicator meaning



Will flash when lifted or climbing an obstacle.



Will flash when no signal received from boundary wire.



Will flash when battery is low.



Will flash when charging in the docking station.

Physical button

LED indicator will show under the working time button that has been selected. Robotic Mower will go back to docking station when the selected time is over.

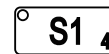

LED will show when signal S1 is selected.

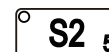

LED will show when signal S2 is selected.



LED will flash slowly when there is no Wifi connection
LED will remain on when ready to connect to Wifi.
LED will flash quickly when successfully connected to Wifi.



LED will show when pressed and will lock the control panel.

Start mowing

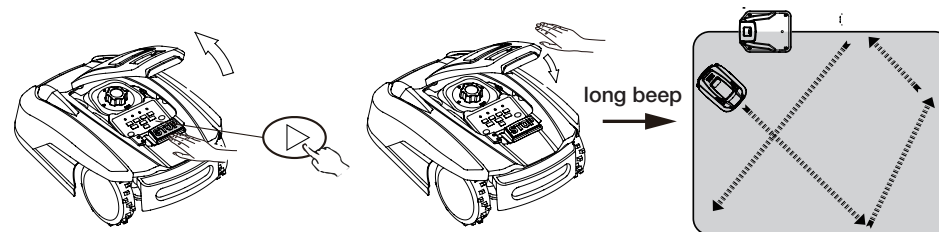

Press start button and close the top cover, Robotic Mower will start to work after after you hear a long beep.

Return to docking station

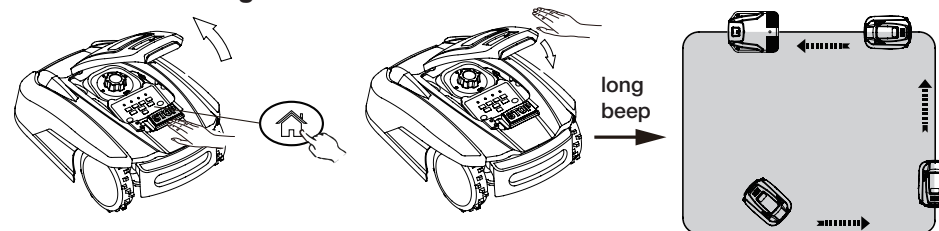

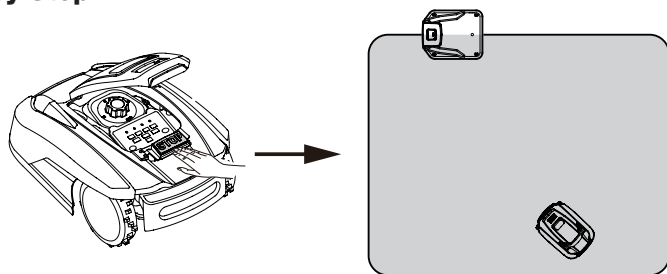

Emergency Stop



Press **STOP** button to break the mower at any time.

Halt the PIN Code

1. Switch OFF the mains power switch.
2. Press and hold the lock button .
3. Hold down the lock button  while switching ON the main power switch. After about 6 seconds, all LEDs on the control panel will start flashing quickly.
4. Release the lock button .
5. Within 6 seconds, enter your new PIN-Code.

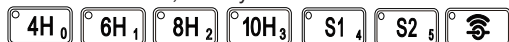

The Robotic Mower will confirm the changed PIN with a single beep.

6. All LEDs will turn off and the Robotic Mower will reboot. The LED of lock button will flash, confirming that the reboot is complete. The Robotic Mower can now be unlocked with the new PIN.

NOTE!

If you do not remember your PIN code, please set a new PIN as described above. It is not possible to reset the device to the default PIN code of "4x .

Cutting height adjustment

Cutting height can be adjusted by rotating the height adjustment dial.

Cutting heights range from 20 - 60mm.

NOTE!

To get the best cutting performance from the Robotic Mower and to avoid any damage, it is advised that you use a lawnmower or grass trimmer to cut the lawn to 60mm or below before using the Robotic Mower.

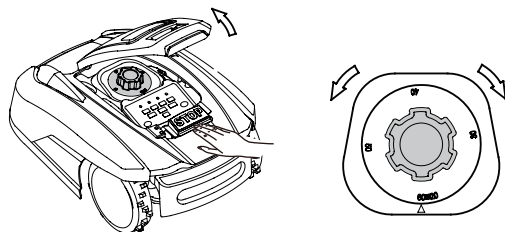

Rain Sensor

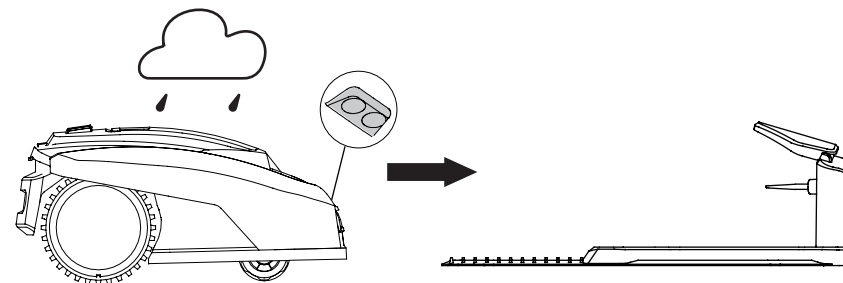

Technical Data

Model	X50i	X60i	X80i	X100i
Max cutting area	500 m ²	600 m ²	800 m ²	1000 m ²
Battery pack	28V/2000mAh	28V/2000mAh	28V/2850mAh	28V/2850mAh
Switching power supply	Input: 100-240V AC, 50/60Hz, 56W Output: 32VDC, CC1.5A			
Mowing time on one charge	60 min	60 min	80 min	80 min
Rated voltage	28 V	28 V	28 V	28 V
Rated power	50 W	50 W	50 W	50 W
No load speed	3500/min	3500/min	3500/min	3500/min
Cutting width	18 cm	18 cm	18 cm	18 cm
Cutting height	Approx 20-60 mm	Approx 20-60 mm	Approx 20-60 mm	Approx 20-60 mm
Charging time	60 min	60 min	90 min	90 min
Weight	8.5 Kg	8.5 Kg	8.5 Kg	8.5 Kg
Degree of protection:				
Robotic Mower	IP24	IP24	IP24	IP24
Switching power supply	IP67, Plug IP44	IP67, Plug IP44	IP67, Plug IP44	IP67, Plug IP44
Spare parts				
Spare Blades	3 Pcs	6 Pcs	6 Pcs	9 Pcs
Boundary pegs	120 Pcs	150 Pcs	200 Pcs	220 Pcs
Boundary wire	100 m	120 m	150 m	200 m
Connectors	3 Pcs	3 Pcs	3 Pcs	3 Pcs

Maintenance and storage

Maintenance work that has not been described in these instructions must be carried out by a servicing agency authorised by the manufacturer. Only use original parts.

Maintenance

Check and clean your Robotic Mower regularly and replace worn parts if necessary. Preferably use a dry brush, a damp cloth or a sharpened wooden piece.

Never use flushing water.

Following these maintenance instructions can extend your Robotic Mower's service life.

Battery Life

The Robotic Mower has a maintenance free Li-ion battery, with an estimated life of more than 2 years (depending on treatment and usage).

Winter Storage

During winter, keep your mower, docking station and power supply in a dry place.

We recommend a shed, garage or preferably store it indoors.

Prepare your device for winter storage as follows:

1. Fully recharge the battery.
2. Set the mains power switch to "OFF".
3. Thoroughly clean your Robotic Mower.
4. Unplug the power supply from the mains outlet.
5. Disconnect the power supply from the docking station.
6. Disconnect the boundary wire from the docking station. Lift up the docking station and clean. The boundary wire can remain outside. However, it is imperative to protect the wire against corrosion. We recommend a water-free grease or suitable sealing tape.

If available, repack the product in the original packaging.

Alternatively, our service centre offers a winter service for your device. This will include a check-up of all parts and - if available - a software upgrade.

Preparing for spring

After winter storage, please clean the charging contacts on both the Robotic Mower and the docking station.

Use a fine abrasion paper or a brass brush; this will help to achieve the best charging efficiency and avoid any charging interference.

Cleaning the mower body

As your Robotic Mower is battery powered you need take care when cleaning. Remove rough dirt with a soft brush. Use a manual water spray with mild household detergent for intensive cleaning. Wipe off any residue after cleaning with a moist rag.

Cleaning the underside

Ensure the main power switch is in OFF position. Wearing protective gloves, turn the Robotic Mower onto its side to expose its underside. Clean the blade disc and frame using a soft brush or damp cloth. Rotate the blade disc to make sure that it can move freely, check that the blades can turn on their pivots and that there is no grass is obstructing them.

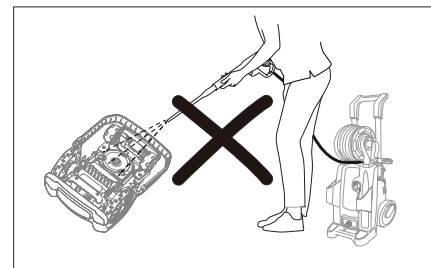

Clean the contact pins and the charging strips

Using wire wool, metal cleaner or very fine grade emery paper, clean the contact pins and the charging strips on your mower and docking station. Remove any debris, leaves, or grass clippings around the contact pins and charging strips to ensure efficient charging.

Reversing or replacing the blades



WARNING!

Ensure the Robotic Mower is completely shut off before cleaning, adjusting or replacing the blades. Always wear protective gloves.



WARNING!

To ensure maximum cutting efficiency and safety, always use recommended replacement blades and blade mounting parts when replacing.

Your Robotic Mower has three blades, fixed to the blades disk.

Unless damaged by hard obstacles, these blades can last for up to five months of everyday use. Weekly inspection of the blades and the fixing screws is advised. Note that the blades are double-edged. When the first side becomes blunt, loosen the fixing screw and the blade upside down and re-fix. Check that the blade can move freely.

A set of spare blades is included with the Robotic Mower. More blades can be purchased via customer support.

To ensure you get the best performance from your machine, always replace all three blades at the same time. Only use spare parts recommended by manufacturer.

Spare parts list

Call the after-sales centre if you want to order below spare parts.

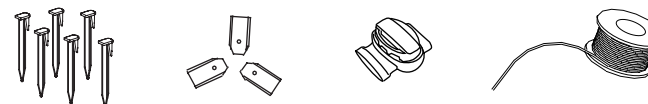

Software Update

Should your machine need a software update, contact our customer service team for more information.

Troubleshooting

Robotic Mower cannot dock with docking station

- Check that the boundary wire in front and underneath the charger is in a straight line.
- Check that the docking station's position is suitable as explained in this manual.

Robotic Mower runs in circles while mowing or while following boundary wire back to docking station.

- Verify that no power cable runs parallel and in close proximity the boundary wire. If necessary, reposition the boundary wire.
- Check if a front wheel is stuck.
- If a neighbor has a similar Robotic Mower, the signals may interfere. Try setting your docking station and Robotic Mower are set to the alternative boundary signal.
- Driving motor may be damaged, please contact customer support.

The Robotic Mower is noisy.

- Inspect the blade fixing screws; tighten if necessary.
- Inspect the blades for damage; replace if necessary.
- Grass may be too high. Try increasing the cutting height, or mow the lawn with an ordinary lawnmower first.
- Cutting motor failure, please call after sales service.

Mower remains at or returns to docking station when pressing START button

- Check if the mower has already completed the programmed working time for that day.
- Battery is low, let give the Robotic Mower time to charge and try again.

LED signal indicator on docking station

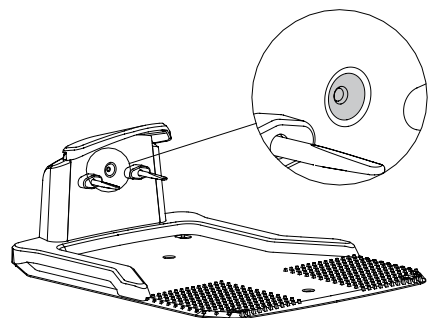

LED Indicator	Meaning
Blue light on	Normal
Red flash	Boundary wire broken

APP



A. Login in:

Please register your account first, you can choose register with email account or mobile phone number.

B. Sign up

After successful registration, you can login in with your account.

C. Explore as guest

You also can find our dealer information and our technical knowhow with guest mode.

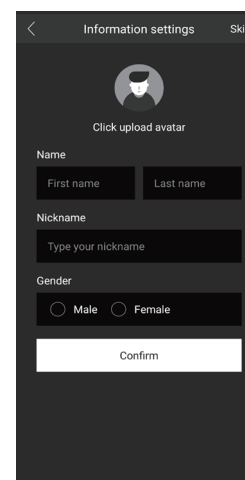

Please fill your personal information and you also can choose Skip and fill later.

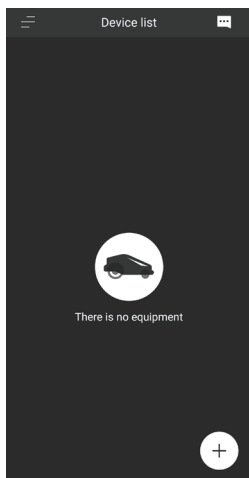

After personal information setting, you will enter main interface of our app, and now you can click lower right corner "+" symbol to add your Robotic Mower.

Register your Robotic Mower

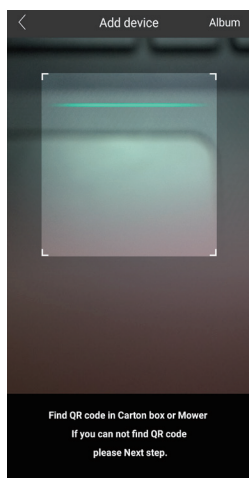

You can add the mower by scanning our mower QR code from nameplate, and you also can input the series number manually which you can find from nameplate also.

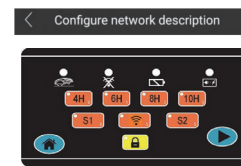

Please follow the instructions, press and hold the WIFI setting button more than 5 seconds, the mower will enter configuration mode.

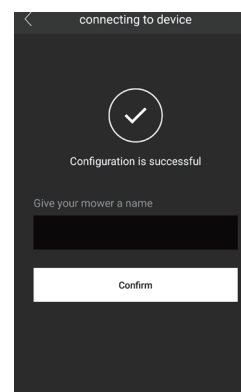
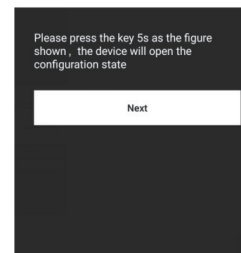

After successful configuration, we will enter mower naming interface, please make an name for your Robotic Mower.

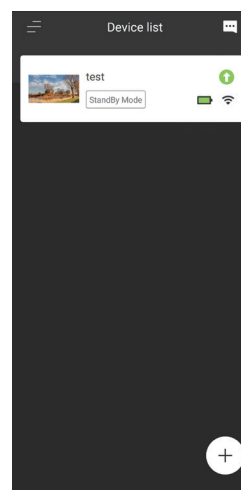

Congratulation, we will find your Robotic Mower on the main interface, now you can remote control this mower, enjoy automatical lawn care.

Enjoy your Robotic Mower

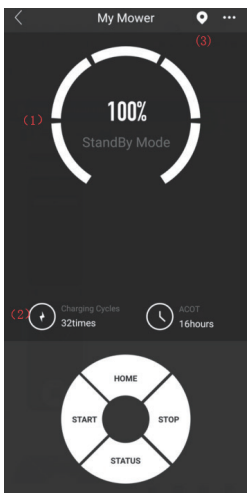

This our mower main control interface, you will battery volume and working mode from upper graphic and remote console pad from lower side.

**At upper right corner, there will be "... " symbol, you can click and enter mower parameter setting interface.*

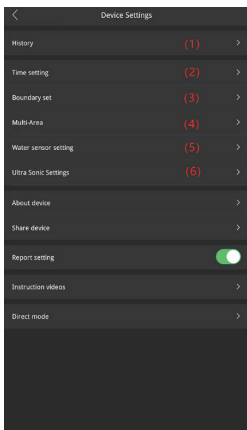

- (1) You can find fault, cutting, cahrging and health history.
- (2) Three working time and seven working days selection is available.
- (3) boundary trim function is available and over boundary cutting distance, boundary singal select buttons.
- (4) Multi-zone cutting function setting, four seperated area is available.
** This is function is available only for some special model.*
- (5) You can choose enable or disable water sensor function.
- (6) You can choose enable or disable ultrasonic sensor function, you also can set ultrasonic action distance from 30cm to 60cm.

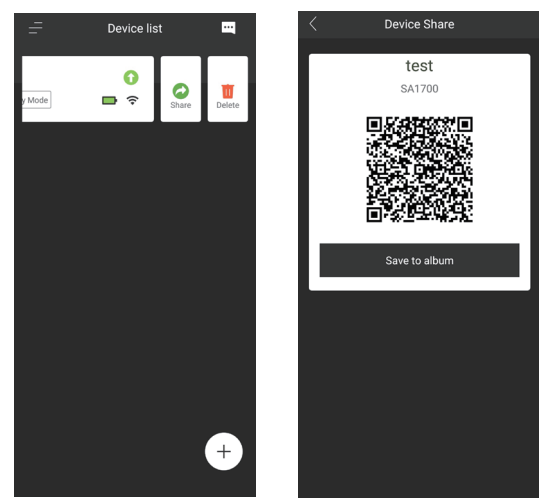

Click your Robotic Mower and left slip, and then you can share the mower with your family together, and more enjoy together.

Direct mode (in case if you do not have WIFI access)

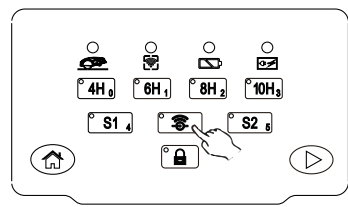

Press and hold WIFI button on mower console pad and then switch on the main power of mower.

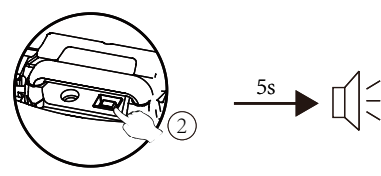

Open the MOWAP program on your mobile phone and choose Direct mode.



Input the PIN code, the initial PIN code of Robotic Mower is: 0000.

