



# YARD FORCE®

LAWN & GARDEN EQUIPMENT

**GM B46**

**XSZ46E**

GB

## PETROL LAWNMOWER

### Original Instructions



**READ & UNDERSTAND  
INSTRUCTION MANUAL**



**Save all warnings and instructions for future reference.**

Email: [support@yardforce.co.uk](mailto:support@yardforce.co.uk)

Website: [www.yardforce.eu/en](http://www.yardforce.eu/en)

SUMEC UK Co Ltd

Escrick Business Park,

Unit A & B, York YO19 6FD

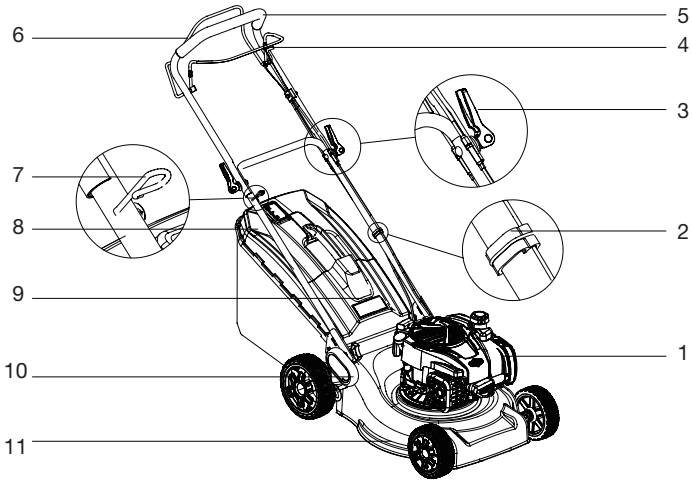
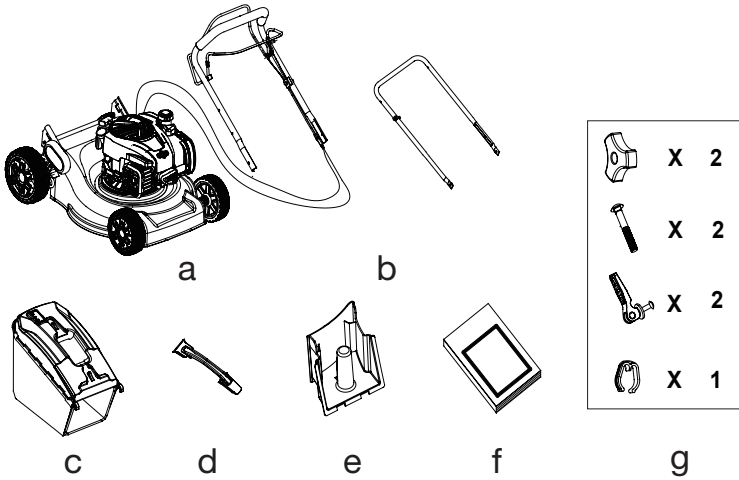

Read this manual carefully prior to assembling and operating the petrol lawnmower. It is dangerous to operate this product without being familiar with these instructions. Keep this manual in a safe place and have it ready for future reference.

**A****B**

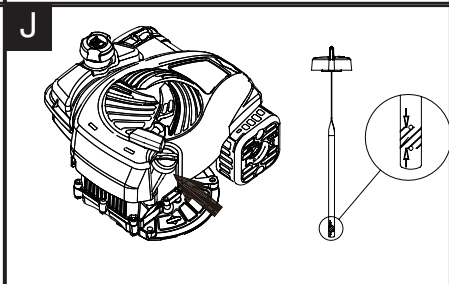
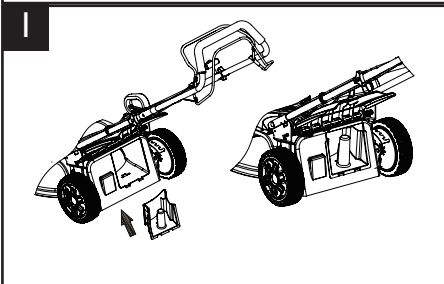
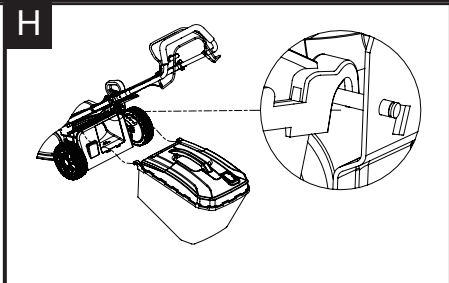
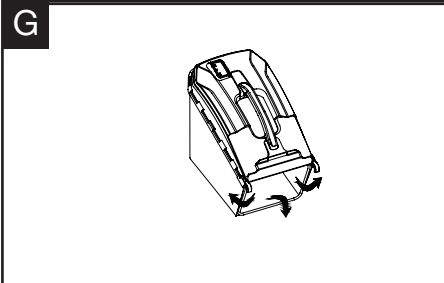
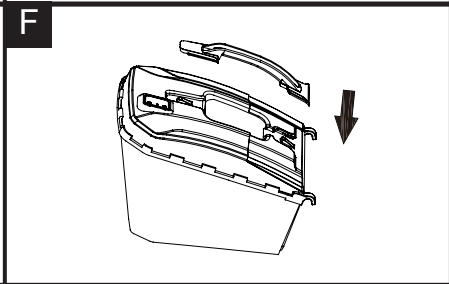
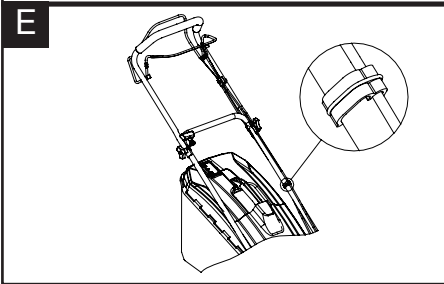
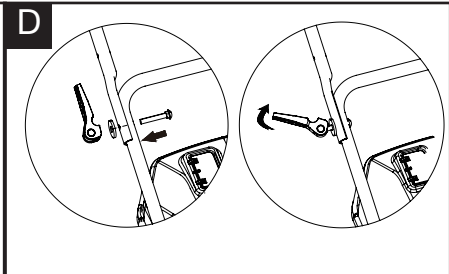
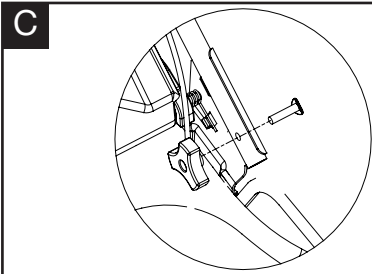

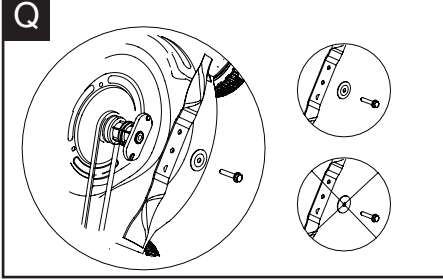
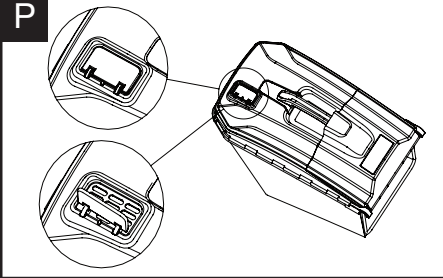
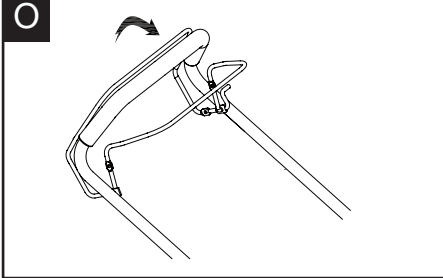
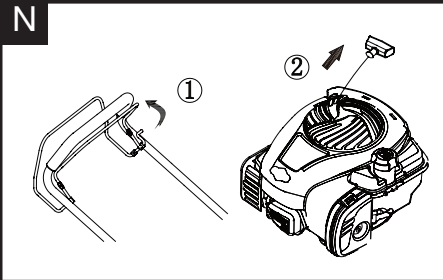
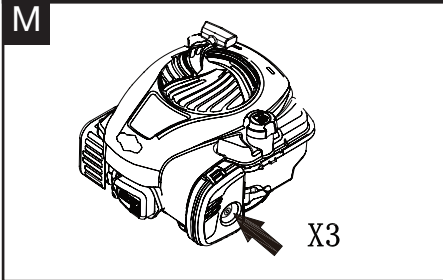
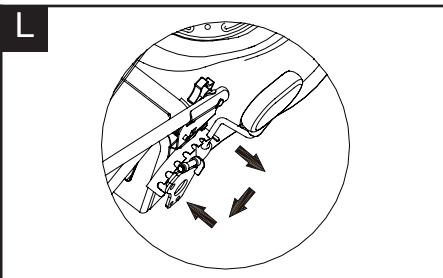
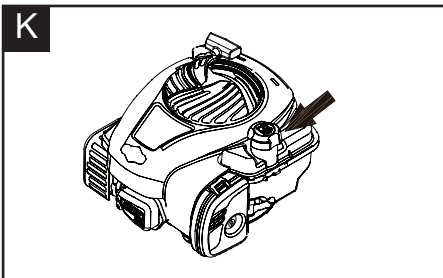

# **YARD FORCE**

## **GM B46 Original Instruction**

### **CONTENT**

Intended use	07
General safety warnings	07
Product safety warnings	10
Symbols	12
Technical data	15
Description of product	16
Installation	17
Operation	18
Maintenance and storage	21
Troubleshooting	24
CE declaration	25

## INTENDED USE

This lawnmower has been designed for cutting grass. The machine is to be used only for its prescribed purpose, any other use is deemed to be a case of misuse. Please note that our equipment has not been designed for use in commercial, trade or industrial applications. Our warranty will be voided if the machine is used in commercial, trade or industrial businesses or for equivalent purposes.

## GENERAL SAFETY WARNINGS

### Safety Warnings



**WARNING: Read all safety warnings and instructions.**

Failure to follow the warnings and instructions may result in electric shock, fire and/or serious injury.



**WARNING! Read all safety warnings and instructions designated by the symbol. Save all warnings and instructions for future reference.**

Always ensure anyone intending to operate this machine is fully conversant with the contents of this instruction manual prior to assembling, maintaining or operating the machine.

Perform assembly operations as described in this manual. Failure to observe this warning may lead to serious injury, death or damage to the machine.

Always take care when removing the packaging, to prevent damage to you or to the machine.

**IMPORTANT!** Before assembling the machine, check all the parts indicated in the manual are in the box. Inspect all the parts for signs of damage. Do not assemble the

## GENERAL SAFETY WARNINGS

machine if you observe any damaged components.

**NOTE:** This lawnmower complies with the Noise Emission Directive 2000/14/EC.

1. Keep this operating and maintenance manual in a safe place for reference at a later date.
2. Read the instructions carefully. Be familiar with the controls and the proper use of the equipment.
3. Never allow children or people unfamiliar with these instructions use the lawnmower. Local regulations can restrict the age of the operator.
4. Never mow while people, especially children or pets, are nearby. Keep in mind that the operator or user is responsible for accidents or hazards occurring to other people or their property.
5. This appliance is not intended for use by people (including children) with reduced physical, sensory or mental capabilities, or lack of experience and knowledge, unless they have been given supervision or instruction concerning the use of the appliance by a person responsible for their safety.
6. Never touch a rotating blade.

### Personal safety

1. **While mowing, always wear substantial footwear and long trousers.** Do not operate the equipment when barefoot or wearing open-toed sandals.
2. **Thoroughly inspect the area where the equipment is to be used and remove all objects which can be thrown by the machine.**



## GENERAL SAFETY WARNINGS

3. **Petrol is highly flammable; store fuel in containers specifically designed for this purpose.**
  - a) Refuel outdoors only and do not smoke while refuelling.
  - b) Add fuel before starting the engine. Never remove the cap of the fuel tank or add petrol while the engine is running or when the engine is hot.
  - c) If petrol is spilled, do not attempt to start the engine but move the machine away from the area of spillage and avoid creating any source of ignition until petrol vapours have dissipated.
  - d) Replace all fuel tank and container caps securely.
4. **Replace faulty silencers.**
5. **Prior to use, visually inspect to see that the blade, blade bolts and cutter assembly are not worn or damaged.** Replace worn or damaged blades and bolts in sets to preserve balance.

### Operation safety

1. **Do not operate the engine in a confined space where dangerous carbon monoxide fumes can collect.**
2. **Mow only in daylight or in good artificial light.**
3. **Avoid operating the equipment on wet grass, where possible.**
4. **Always be sure of your footing on slopes.**
5. **Walk, never run.**
6. **Mow across the face of a slope, never up and down.**
7. **Exercise extreme caution when changing direction**

## PRODUCT SAFETY WARNINGS

on slopes.

8. Do not mow excessively steep slopes.
9. Use extreme caution when reversing or pulling the lawnmower towards you.
10. Stop the blade if the lawnmower has to be tilted for transportation when crossing surfaces other than grass and when transporting the lawnmower to and from the area to be mowed.
11. Never operate the lawnmower with defective guards or without safety devices, for example deflectors and/or grass catchers, in place.
12. Do not attempt to change the engine governor settings or overload the engine.
13. Start the engine carefully according to the instructions and with feet well away from the blade.
14. Do not tilt the lawnmower when starting the engine.
15. Do not start the engine without the grass collector in place.
16. Do not put hands or feet near or under rotating parts. Keep clear of the discharge opening at all times.
17. Never pick up or carry a lawnmower while the engine is running.
18. Stop the engine and disconnect the spark plug cable, making sure that all moving parts have come to a complete stop:
  - a) Before clearing blockages or unclogging the chute.
  - b) Before checking, cleaning or working on the lawnmower.
  - c) After striking a foreign object, inspect the

## PRODUCT SAFETY WARNINGS

lawnmower for damage and make repairs before restarting and operating the lawnmower.

- d) If the lawnmower starts to vibrate abnormally, check immediately.
19. Stop the engine and disconnect the spark plug wire, and make sure that all moving parts have come to a complete stop before refuelling.

### **Maintenance and storage**

1. Keep all nuts, bolts and screws tight to be sure the equipment is in safe working condition.
2. Never store the equipment with petrol in the tank inside a building where fumes can reach an open flame or spark.
3. Allow the engine to cool before storing in any enclosure.
4. To reduce the fire hazard, keep the engine, silencer and petrol storage area free of grass, leaves or excessive grease.
5. Check the grass collector frequently for wear or deterioration.
6. For safety, always replace worn or damaged parts.
7. If the fuel tank has to be drained, this should be done outdoors.

### Safety symbols

The purpose of safety symbols is to attract your attention to possible dangers. The safety symbols and the explanations with them require your careful attention and full understanding. The symbol warnings do not, by themselves, eliminate any danger. The instructions and warnings they give are no substitutes for proper accident prevention measures.

**WARNING:** Be sure to read and understand all safety instructions in this operator's manual, including all safety alert symbols such as "**DANGER**," "**WARNING**," and "**CAUTION**" before using this tool. Failure to follow all instructions listed below may result in electric shock, fire and/or serious personal injury.

**SAFETY ALERT SYMBOL:** Indicates **DANGER**, **WARNING**, or **CAUTION**. May be used in conjunction with other symbols or pictographs.

### Symbol meaning

This page depicts and describes safety symbols that may appear on this product. Read, understand and follow all instructions on the machine before attempting to assemble and operate.

## SYMBOLS



Please read all of the safety and operating instructions carefully before using this machine.



Read the instruction manual before operating.



Keep bystanders away - especially children and pets.



Beware of sharp blades - remove the spark plug lead before maintenance



No naked flames.



Appropriate ear, eye and head protection (PPE) must be worn.



Add engine oil.

Only refuel with unleaded petrol.



Hot surfaces will burn the hands!



Warning! The lawnmower's exhaust gas contains toxic substances. Do not run the engine in closed or poorly-ventilated areas.

## SYMBOLS



The blade continues to rotate for a period after the machine is switched off. Do not touch the blade until all the machine components have stopped completely.



The product complies with the applicable European directives, and an evaluation method of conformity for these directives was done.



Sound level data (96 dB), in accordance with Directive 2000/14/EC.

## TECHNICAL DATA

Model	GM B46
Engine type	Single cylinder 4-stroke
Engine displacement	140cm <sup>3</sup>
Engine power	2.1kW
Max. engine speed	2900r/min
Cutting width	46cm
Grass bag capacity	55L
Ignition	T.C.I
Fuel tank capacity	0.8L
Oil tank capacity	0.47L
Measured sound power level	96 dB(A) K=1.5dB(A)
Guaranteed sound power level	95 dB(A)
Vibration	6m/s <sup>2</sup> k=1.5m/s <sup>2</sup>
Spark type	QC12YC
Net weight	26kg



**WARNING:** Depending on how the product is actually used, the vibration values can differ from the declared total! Adopt proper measures to protect yourself against vibration exposures. Take the whole work process, including times the product is running under no load or switched off, into consideration. Proper measures include, among others, regular maintenance and care of the product and its attachments, keeping hands warm, regular breaks and proper planning of work processes.

## DESCRIPTION OF PRODUCT

### Parts description (Fig. A)

1. Engine-B&S 500E
2. Cable clip
3. Handle quick release lever
4. Start/stop lever
5. Top handle
6. Self-propelled switch lever
7. Rope guide
8. Grass bag
9. Safety flap
10. Cutting height adjustment lever
11. Deck

### Check the delivery parts (Fig. B)

Remove the machine from its packaging carefully and make sure that all of the following parts are present:

- a. Main mower deck (with upper handle)
- b. Lower handle
- c. Grass bag
- d. Grass bag handle
- e. Mulching plug
- f. Manual
- g. Accessories



**WARNING:** If any parts are damaged or missing, do not operate this tool until these parts are replaced. Failure to heed this warning could result in serious personal injury.



**NOTE:** Always recycle the packaging in accordance with local recycling guidelines.



## INSTALLATION

### Installing the handle

1. Attach the lower handle onto the unit by using one bolt and one handle tensioning knob on each side. **(Fig. C)**
2. Install the upper handle onto the lower handle by using one handle quick release lever each side. **(Fig. D)**

### Fitting the cable clip

Ensure that the cable clips supplied are used to fix the cable to the lower handle. **(Fig. E)**

### Mowing with grass collection bag

1. Attach the grass bag handle to the grass bag. **(Fig. F)**
2. Attach the grass bag to the frame by fixing all plastic hooks. **(Fig. G)**
3. Lift the safety flap with one hand and hook in the grass bag. **(Fig. H)**
4. Release the safety flap to secure the grass bag in position.

### Mowing with mulching plug

1. Remove the grass bag.
2. Push the plastic mulching plug into the discharge chute. **(Fig. I)**
3. Release the flap, it will close back to cover the mulching plug.

## OPERATION

### Filling with engine oil



**IMPORTANT!** The following procedures and adjustments must be performed before the engine is started. Do not attempt to make any of these adjustments while the engine is running.

This engine is shipped without oil or petrol, any oil residue is from testing prior to shipping. The engine must be filled with the correct grade of oil and petrol before starting the engine. Running the engine with a low oil level will cause irreparable engine damage. Always use high-quality detergent oil classified SAE 30 oil (or equivalent, e.g. 5W 30, often termed as 4-stroke lawnmower oil). Only use additives recommended by the engine manufacturer. To prolong the life of your engine, it is important that the oil is changed after the first 5 hours of use.

Check the engine oil level with the engine stopped and the mower on a level surface.

1. Remove the oil filler dipstick and wipe oil from it with a clean cloth.
2. Insert the dipstick into the oil filler neck, and screw it in.
3. Remove the dipstick and check the oil level. The oil level must be between the min. and max. marks on the dipstick. If near the lower level, fill to the upper level with the recommended oil (SAE 30 or equivalent). Do not overfill. Wipe away any spilt oil. **(Fig. J)**
4. Before using for the first time, add 0.5 litres of oil (SAE 30).

### Filling with engine fuel (Fig. K)



**WARNING!**

Refuel in a well-ventilated area with the engine stopped. Do not smoke or allow flames or sparks in the area where the engine is refueled or where petrol is stored. Avoid repeated or prolonged contact with skin or inhalation of vapour.



**CAUTION!**

Petrol is highly flammable and extreme caution must be taken when handling or working with it. Keep out of reach of children.

1. Clean the area around the petrol filler cap before removing. Check the fuel level.
2. Refill the tank if the fuel level is low.
3. Always use clean, fresh unleaded petrol and purchase fuel in quantities that can be used within 30 days.

Never mix oil with petrol.

To allow for expansion, carefully refuel and avoid overfilling or spillage. There should be no fuel in the filler neck.

Clean up any overflow or splashes of petrol before starting the engine.

Tighten the filler cap after filling, finger tight only.

## OPERATION

### Setting the cutting height (Fig. L)



#### WARNING!

The blade can cause serious injury. Before adjusting the mower height, stop the engine and wait for the mower blade to come to a complete stop.

1. Pull the lever towards the wheel, then move it forward or backward to adjust the cutting height.
2. Move it to any one of the 7 positions for the desired cutting height.
3. Return the lever into the securing plate.

**NOTE:** Never use the lowest cutting height for the first cut of the season or in drought conditions. Only about one third of the grass height should be cut at this time.

### Starting the engine



#### WARNING!

Do not operate the machine in enclosed or poorly-ventilated areas, as the exhaust gas contains toxic substances. Keep hands, feet, hair and clothing away from all the moving parts of the machine. The exhaust and other parts of the machine will become hot during use. Make sure that the blade is securely fastened before starting the engine.

1. When starting a cold engine, press down the primer fully 3-5 times. **(Fig. M)**

**Pressing the primer button too many times could cause the engine to flood.**

**NOTE:** When starting a warm engine, the primer does not need to be used. If the engine stops due to a lack of petrol, refill and press down the primer 3-5 times.

2. Start/stop bar activation  
Pull the start/stop bar towards you. **(Fig. N)**
3. Pull cord handle  
With the right hand, slowly but firmly pull the starter handle and rope from the pull cord guide until you feel resistance, then pull briskly. If the engine fails to start after three pulls, repeat the start process. When the engine starts, return the starter rope to the rope guide gently.

### To stop, release stop/start bar

#### Failure to start

If the engine won't start after you have operated the starter several times, the engine may be flooded with excess fuel.

Use the following procedure to clean and start a flooded engine:

- A. Release the stop/start bar.
- B. Remove the spark plug, dry it, and then reinstall it.  
Install the spark plug carefully by hand, to avoid cross-threading. After the plug is seated, tighten it 1/8 to 1/4 turns with the socket spanner to compress the washer.
- C. Pull the stop/start bar towards the upper handle.
- D. Operate the starter, as described above.

## OPERATION

### Using the Self-propelled function

1. This lawnmower equipped with self-propelled system.
2. Push the self-propelled rear switch bar towards the handle and hold it in position. The lawnmower will start to move automatically. **(Fig. O)**
3. To stop the moving lawnmower, simply release the drive.

### Mowing with collection bag



#### **WARNING!**

Always observe the strictest safety procedures when using the lawnmower.

Start the engine and allow it to run.

Keep a firm grip on the upper handle and stop/start bar and walk along with it. Never run with the mower. Be very careful when mowing uneven or rough ground. Maintain a stable footing. Mow across slopes, never up and down. Be careful when changing the direction of the mower on a slope. Do not use the mower on a steep slope of more than 15°.

#### **NOTE:**

The best result will be achieved if the grass is dry. Wet grass tends to clog the blade and the grass collection system.

Grass grows at different rates at different times of the year. Never use the lowest cutting height for the first cut of the season or in drought conditions. Only about one third of the grass height should be cut.

If the lawnmower will not collect the cuttings efficiently, the grass discharge chute may be blocked, the grass bag may be full or the underside of the mower deck may be clogged.

#### **Function of full indicator (Fig. P)**

If the grass bag is empty or it is not filled with grass, the grass full indicator will be open.

If the grass bag is filled with grass the grass full indicator will be closed.

### Emptying the grass bag

Raise the discharge flap with one hand and remove the grass bag using its handle with your other hand. To maintain safety, the discharge flap will close back to cover the mulching plug when you release the flap.

Empty the grass debris in the grass collection bag and refit the bag. If any grass residues are caught in the discharge chute, clean it using a nylon-bristled brush.

### Mowing with mulching

When mulching, remove the collection grass bag and put the plastic mulching plug into the rear discharge chute. Then release the flap, it will close back to cover the mulching plug.

**NOTE:** To ensure that the cut grass can be mulched efficiently, do not cut high or wet grass

## MAINTENANCE AND STORAGE

### Storing the lawnmower for short periods

After mowing, please follow the actions below prior to placing the lawnmower in storage:

- Allow the engine to fully cool.
- Ensure the grass bag is empty.
- Clean all debris from under the mower deck.

Store the lawnmower on a flat and level surface with all 4 wheels on the ground.

Store in a dry, safe place which is not accessible by children or people who are not familiar with operation.

### Storing the lawnmower for extended periods



**CAUTION!** Do not empty the petrol tank in enclosed areas, near fire or when smoking. Petrol fumes can cause explosions and fire. Always carry the product on its gripping surfaces.

If the lawnmower is to be placed into storage at the end of the season, or if the mower is not to be used for a longer period than 6 weeks, storage maintenance must be performed on the lawnmower.

Temperature fluctuations cause condensation, which contaminates fuel and causes starting problems. Simply emptying the machine of fuel will prevent this.

Empty the petrol tank with a petrol suction pump, if available, or use the tipping method.

Start the engine and let it run until any remaining petrol has been used up.

Change the oil at the end of every season. To do so, remove the used engine oil from a warm engine and refill with fresh oil.

Remove the spark plug from the cylinder head. Fill the cylinder with approx. 20ml of oil from an oil can. Slowly pull back the starter handle, which will bathe the cylinder wall with oil, and screw the spark plug back in.

Clean the cooling fins of the cylinder and the housing.

Be sure to clean the entire machine to protect the paint.

Store the machine in a well-ventilated place.

### Maintenance schedule



#### **WARNING!**

Before you tip the lawnmower onto its side, completely empty the fuel tank using a petrol suction pump.

Never turn the mower upside down.

Before commencing any maintenance, always disconnect the spark plug.

Performing routine maintenance correctly on your lawnmower will ensure you get years of trouble-free use.

Please keep this manual safe for future reference.

It is recommended that the following maintenance schedule is adhered to. This will ensure the lawnmower operates correctly and is safe to use.

## MAINTENANCE AND STORAGE

	After every use	After 12 hours use	After 24 hours use	After 36 hours use
Cleaning	Clean	Clean	Clean	Clean
Air filter	/	Clean	Clean	replace
Spark plug	/	check	check	replace
Engine oil	check	check	check	check
Cutting blade	check	check	check	replace

### Cleaning

1. To ensure long life and good performance of the machine, it is important to keep the machine clean and well lubricated. Make sure the chute is clean and under the deck is cleared from wet debris (see also short term storage).
2. Do not allow grass cuttings and other debris to become dry and hard on any of the mower surfaces, as this will directly affect the cutting and grass collection performance. Make sure that the underside of the lawnmower deck is clean and clear.
3. Never clean the lawnmower with a water jet or high-pressure cleaner. The engine must remain dry. Do not use aggressive cleaning agents or solvents, such as cold degreasers or petroleum ether.

### Cleaning or replacing the air filter



#### **WARNING!**

Never run the engine without the air filter element installed:

1. Loosen the fastener that holds the cover.
2. Open the cover and remove the filter.
3. To loosen debris, gently tap the filter on a hard surface. If the filter is excessively dirty, replace with a new filter.
4. Install the filter.
5. Install the cover tabs into the slots.
6. Close the cover and secure with the fastener.

### Cleaning or replacing the spark plug

1. Once the engine has cooled, pull off the spark plug boot with a twist. Remove the spark plug using the socket spanner supplied.
2. Clean the plug with a wire brush.
3. Using a feeler gauge, set the gap to 0.51mm.
4. Install the spark plug carefully by hand to avoid cross-threading.
5. After the spark plug is seated, tighten with the spanner to compress the washer.

### Changing the oil

Tilt the lawnmower towards the oil filler, have a container ready to catch the oil and remove the dipstick. Once the oil has been emptied, wipe clean any spillages.

Refill with 470ml SAE 30 oil or equivalent, i.e. SAE 5W/30, SAE 10W/30). When the dipstick is rested on the filler pipe, the oil level must be between the min. and max. marks on the dipstick.

## MAINTENANCE AND STORAGE

See 'Filling with engine oil'. Do not overfill.

Start the engine and allow it to run briefly.

Stop the engine, wait one minute and check the oil level. Top up if necessary.

### Replacing the cutting blade (Fig. Q)



**WARNING! USE GLOVES.**

Before you remove the grass collection bag, stop the engine and wait until the blade stops completely.

You will need garden gloves (not provided) and a spanner wrench to remove the blade.

Always handle the blade with care - sharp edges could cause injury.

Don't hold the blade directly by hand.

Renew your metal blade after 36 hours of mowing or after 2 years, whichever comes first, regardless of condition.

Regularly check your blade. If the cut of your grass is poor, the blade might be blunt.

Damaged blades not only result in a bad cut, they cause excessive vibration and uneconomical running of the engine. If the blade has worn excessively and become pitted and blunt, it should be replaced or sharpened.

Tip the machine slightly towards the oil filler pipe and reach under the deck.

Hold the blade and unscrew the blade bolt counterclockwise using a spanner wrench.

Remove the washer and the blade.

Inspect the blade adaptor for any signs of damage.

Fit a new blade, locate the blade on the two studs on the blade flange and then replace the washer and bolts.

Check the washer is still slightly domed to keep the pressure on the bolt to stop it unwinding, keeping the blade firmly secure. Then replace the washer (right way round!) and bolts.

Make sure the blade is correctly positioned and then firmly tighten the bolt. Do not over tighten. The up turn of the blade must project into the motor compartment.

## TROUBLESHOOTING



**WARNING:** Always switch off the engine and pull the ignition cable before starting any inspection or adjustment work.

If after making an adjustment or repair to the engine you let it run for a few minutes, remember that the exhaust and other parts will get hot.

The following table provides solutions to common problems encountered with the lawnmower:

Fault	Possible cause	Solution
Loud while running, machine vibrates heavily	<ul style="list-style-type: none"> <li>- Screws are loose</li> <li>- Blade fasteners are loose</li> <li>- Blade is unbalanced</li> </ul>	<ul style="list-style-type: none"> <li>- Check screws</li> <li>- Check blade fasteners</li> <li>- Replace blade</li> </ul>
Engine does not start	<ul style="list-style-type: none"> <li>- Start/stop bar not pressed</li> <li>- Primer bulb is empty</li> <li>- Spark plug is defective</li> <li>- Fuel tank is empty</li> <li>- Engine may be flooded</li> </ul>	<ul style="list-style-type: none"> <li>- Press start/stop bar</li> <li>- Press primer bulb 3-5 times</li> <li>- Replace spark plug</li> <li>- Refill with fuel</li> <li>- Remove plug and dry,</li> </ul>
Engine runs unsteadily	<ul style="list-style-type: none"> <li>- Air filter is soiled</li> <li>- Spark plug is soiled</li> </ul>	<ul style="list-style-type: none"> <li>- Clean the air filter</li> <li>- Clean the spark plug</li> </ul>
Uneven mowing results	<ul style="list-style-type: none"> <li>- Blade is blunt</li> <li>- Cutting height is too low</li> </ul>	<ul style="list-style-type: none"> <li>- Sharpen the blade</li> <li>- Set correct height</li> </ul>
Unsatisfactory grass collection	<ul style="list-style-type: none"> <li>- Cutting height is too low</li> <li>- Blade is worn</li> <li>- Grass bag is clogged</li> </ul>	<ul style="list-style-type: none"> <li>- Set correct height</li> <li>- Replace the blade</li> <li>- Clear any clogged grass debris</li> </ul>



## CE DECLARATION

Au vu des dispositions des directives du Conseil

Nous  
SUMEC UK Co.,Ltd.  
Unit A&B, Escrick Business Park  
Escrick, York YO 19 6FD

**Déclarons que le produit :**

Description de l'outil : Tondeuse à Gazon Thermique  
Type d'outil : GM B46/XSZ46E  
Fonction : Coupe d'herbe

**Est conforme aux exigences en matière de santé et de sécurité des directives suivantes :**

Directive Machine 2006/42/CE

Directive Compatibilité Électromagnétique 2014/30/UE

Directive émissions sonores dans l'environnement des matériels destinés à être utilisés à l'extérieur des bâtiments 2000/14/EG, amendée par 2005/88/EG

Procédure d'évaluation de la conformité selon l'annexe VI

Niveau de puissance acoustique mesuré : 93.4 dB(A)

Niveau de puissance acoustique garanti déclaré: 96 dB (A)

Organisme relatif notifié (NB no.0359):

Intertek Testing & Certification Ltd., Davy Avenue, Knowlhill, Milton Keynes, MK5 8NL

**Normes et spécifications techniques applicables :**

EN ISO 5395-1:2013

EN ISO 5395-2:2013+A1:2016+A2:2017

EN ISO 14982:2009

Signataire autorisé

Date: 11.10.2017

Signature: \_\_\_\_\_



Lieu: York

Nom: Mariana Hall

Directrice générale

SUMEC UK  
Unit A&B Escrick Business Park  
Escrick, York  
YO19 6FD

