

challenge
xtreme
READY FOR THE CHALLENGE

800W
TABLE SAW



CE



TS200/800C2
ORIGINAL INSTRUCTIONS

INTRODUCTION

Thank you for purchasing a CHALLENGE XTREME 800W Table Saw. We would like you to be completely satisfied with your new product and hope you get many years of satisfaction out of this tool.

Your table saw is designed to saw workpieces with a maximum thickness of 45 mm. It is intended in particular for use by DIY enthusiasts and craftsmen.

The machine is to be used for wood cutting. Never use it cut the metal or tile material.

GENERAL SAFETY INSTRUCTIONS

When using electric products, in order to reduce the risk of fire, electric shock or personal injury, it is recommended to always respect basic safety precautions including the following:

Read all of these instructions before operating the tool and keep these instructions.

1. Work Area Safety

- a. **Keep work area clean and well lit.** Cluttered and dark areas invite accidents.
- b. **Consider work area environment.** Do not operate power tools in the presence of flammable liquids, gases or dust. Power tools will create sparks which may ignite combustible liquids, gases or dust.
- c. **Keep children and bystanders away.** All visitors should be kept away from work area. Distractions can cause you to lose control.

2. Electrical Safety

- a. **Store idle tools.** When not in use, tools should be stored in a dry, high or locked-up place, out of the reach of children.
- b. **Guard against electric shock.** Avoid body contact with earthed or grounded surfaces (e.g. pipes, radiators, ranges, refrigerators etc.)
- c. **Do not abuse the cord.** Never carry tool by cord or yank it to disconnect it from wall outlet. Keep cord away from heat, oil, sharp edges and moving parts. Damage or entangled cords increase the risk of electric shocks.
- d. **Outdoor use extension cords.** When tool is used outdoors, use only extension cords intended for use outdoors and marked as such.
- e. **Use a residual current device (RCD) protected supply.** Use of a RCD will reduce the risk of electric shock to the user.
- f. **Power tool plugs must match the outlet.** Never modify the plug in any way. Do not use any adapter plugs with earthed (grounded) power tools.
- g. **Do not expose power tools to rain or wet conditions.** Water ingress will increase the risk of electric shock.

3. Personal Safety

- a. **Remain Alert and use common sense when operating a power tool.** Do not use a power tool when tired or under the influence of drugs, alcohol or medication. A moment of inattention can result in serious injury.
- b. **Dress properly.** Do not wear loose clothing or jewelry as they can be caught in moving parts.
- c. **Use protective personal equipment.** Always wear eye protection. When using the product, the use of personal protection equipment e.g. gloves, ear protection, goggles, mask and protective shoes will reduce personal injury. Rubber gloves and non-slip footwear are recommended when working outdoors. Wear protective hair covering to contain long hair.

ORIGINAL INSTRUCTIONS

- d. **Avoid accidental starting.** Ensure the switch is in the off position before plugging in. Do not carry plugged-in tools with your finger on the switch.
- e. **Disconnect tools.** Cut off the power when not in use, before servicing, and when changing accessories such as blades, bits and cutters.
- f. **Do not overreach.** Keep proper footing and balance at all times. This ensures optimum control of the tool.
- g. **Use dust extraction.** If dust extraction and collection devices are present on the tool, make sure that they will be used properly.

4. Power Tool Use and Care

- a. **Do not force tool.** It will do a better job and operate more safely at the rate for which it was intended.
- b. **Use the correct tool for the job.** Do not force small tools or attachments to do the job of a heavy duty tool. Do not use tools for other than their intended purpose; for example do not use a circular saw for cutting tree limbs or logs.
- c. **Do not use tool if switch does not turn it on and off.** Any tool that cannot be controlled by the power switch is dangerous and must be repaired.
- d. **Store idle power tool out of the reach of children and do not allow persons** unfamiliar with the power tool or these instructions to operate the power tool. Power tools are dangerous in the hands of untrained or unskilled users.
- e. **Maintain tools with care.** Check for alignment or binding of moving parts, breakage of parts, mounting, and any other conditions that may affect its operation. Keep handles dry, clean and free from oil and grease. Before use inspect the tool to determine that it will operate properly and perform its intended function. Keep tools sharp and clean for better and safer performance. Follow instructions for lubricating and changing accessories
- f. **Check for damaged parts.** Any

component of the tool that is damaged should be properly repaired or replaced by an authorized service center unless otherwise indicated elsewhere in the instruction manual and if damaged, have them repaired by an authorized service facility. Inspect extension cords periodically and replace if damaged.

- g. **Keep tools sharp and clean for better and safer performance.** Follow instructions for lubricating and changing accessories. The use of any other accessory or attachment other than recommended in the instruction manual may present a risk of personal injury
- h. **Remove adjustment tools and wrenches.** Checking to see that adjustment tools and wrenches are removed from the tool before switching it on.

5. Servicing

- a. **Have your tool serviced by a qualified repair person using only identical replacement parts.** This electric appliance is built in accordance with the relevant safety rules. Repair of electric appliances must only be carried out by experts otherwise it may cause considerable danger for the user.

ADDITIONAL SAFETY INSTRUCTIONS FOR TABLE SAW

- 1. **Ensure that other people are kept a safe distance from your workplace. Anyone entering the workplace must wear personal protective gear.** Debris from the work piece may be ejected and cause injuries even outside the direct working area.
- 2. **Only use the power tool for those materials specified under intended use.** The power tool may otherwise be overloaded.
- 3. **Do not stand on the power tool.** There is a risk of serious injury if the power tool tips over or if you accidentally come into contact with the saw blade.

4. **Always make sure that the saw blade guard functions correctly and moves freely.** Set the saw blade guard in such a way that it rests gently on the work piece. Never fix the saw blade guard in place.
5. **Never bring your hands into the sawing area when the power tool is running.** Contact with the saw blade holds a risk of serious injury.
6. **Never reach behind the saw blade to hold the work piece or to remove shavings.** The distance between your hand and the operating saw blade is too small.
7. **Only guide the work piece as far as the operating saw blade.** Otherwise there is a risk of kickback if the saw blade becomes jammed in the work piece.
8. **Use the power tool only when the work surface is free from all adjusting tools, wood shavings etc.** Objects that come into contact with the rotating saw blade may be propelled towards the operator at a high speed.
9. **Always saw one work piece at a time.** Work pieces that are stacked up or stacked against each other may block the saw blade or slide about during sawing.
10. **Long work pieces must be supported at the free end.** Unsupported swinging work piece ends may cause loss of control.
11. **Always use the parallel guide.** This improves the accuracy of the cut and reduces the possibility of a jammed saw blade.
12. **When the saw blade binds, switch the power tool off and do not move the work piece until the saw blade comes to a complete standstill.** In order to prevent kickback, only move the work piece after the saw blade has come to a standstill. Eliminate the cause of the jamming blade before you start the power tool back up again.
13. **Do not use accessories that have not been designed and recommended by the manufacturer for this specific power tool.** Just because you are able to attach an accessory to your power tool this does not guarantee that it is safe to use.
14. **Do not use blunt, cracked, deformed or damaged blades.** Only replace the saw blade with a blade that meets the European norm EN 847-1. The saw blade must meet the specifications given in the technical data section. Blades with blunt or incorrectly oriented teeth will cause increased friction and jamming of the blade as well as kickback.
15. **Always make sure that the splitting wedge matches the dimensions of the saw blade and is correctly aligned. The splitting wedge may not be thicker than the cutting groove width and it may not be thinner than the body of the saw blade.** Otherwise there is a risk that the splitting wedge may get caught in the work piece.
16. **Always use blades with correct size and shape of center hole.** Saw blades that do not match the saw will run unevenly and will lead to a loss of control.
17. **Do not use saw blades made from high-alloyed high-speed steel (HSS).** Such blades may break easily.
18. **Never use the tool without the bench inlays. Replace defective bench inlays.** Without a bench inlay in perfect condition, you may injure yourself on the power tool.
19. **When using the power tool always wear dust mask! When processing wood, always connect dust collection equipment.** Some wood dusts are dangerous.
20. **Store the unused power tool safely in a dry place that can be secured.** This ensures that the power tool is not damaged as a result of storage and that inexperienced persons do not operate it.

ORIGINAL INSTRUCTIONS

21. **Never leave the power tool unattached until it has come to a completed standstill.** Tools that continue to operate may cause injury.
22. **Never use the power tool with a damaged cable. Do not touch the damaged cable and pull out the power plug immediately.** Damaged cables increase the risk of electric shock.
23. **Prevent overheating of the device and the work piece.** Excess heat may damage the tool and the device.
24. **Shortly after being used, the tool may be very hot. Allow a hot tool to cool down.** Touching a hot tool may cause burns.
25. **Never clean a hot tool with flammable liquids.** There is a risk of fire and explosion.
26. **Wear ear defenders when working.** The excessive noise exposure can lead to loss of hearing.
27. **Keep the handles dry and free of grease.** Slippery handles can lead to accidents.
28. **Always comply with the all applicable domestic and international safety, health, and working regulations.** Familiarise yourself before you start work about the regulations that apply at the site of the device.
29. **Always use protective gloves to change the saw blade.** A still saw blade can still cause injury!
30. **After switching off the unit, do not attempt to stop the blade by applying pressure from the side.** Touching the saw blade may lead to injuries.
31. **Do not allow dust to build up at your workplace.** Dust can ignite easily.
32. Symbols affixed to your device should not be removed or covered. Information on the device that is no longer legible must be replaced immediately.



Warning!

Some dust created by power sanding, sawing, grinding, drilling, and other construction activities contains chemicals known to cause cancer, birth defects or other reproductive harm. Some examples of these chemicals are:

- lead from lead-based paints,
- crystalline silica from bricks and cement and other masonry products, and
- arsenic and chromium from chemically-treated lumber.

Your risk from these exposures varies, depending on how often you do this type of work. To reduce your exposure to these chemicals: work in a well ventilated area, and work with approved safety equipment, such as those dust masks that are specially designed to filter out microscopic particles.

SYMBOLS



To reduce the risk of injury, user must read instruction manual



Warning



Wear eye protection



Wear ear protection



Wear dust mask



Waste electrical products should not be disposed of with household waste. Please recycle where facilities exist. Check with your local authorities or retailer for recycling advice.

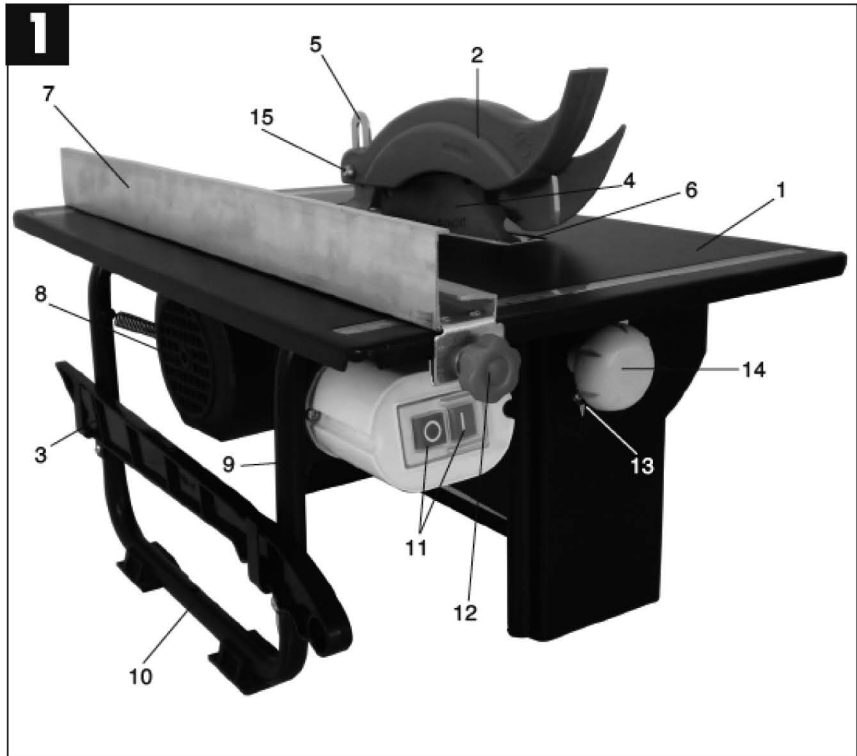

COMPONENT LIST

1. Saw table
2. Blade guard
3. Push stick
4. Saw blade
5. Splitter
6. Table insert
7. Parallel guide
8. Motor
9. Mains cable
10. Stand
11. On/Off switch
12. Locking knob for parallel guide
13. Scale for angle settings
14. Locking knob for cutting depth
15. Guard connecting screw

CHECK THE DELIVERY PARTS

Carefully remove the machine from its packaging and check as the following parts are complete:

- 800W table saw
- 1 x 200mm saw blade (pre-assembled on the machine)
- 1 x parallel guide
- 2 x locking knobs for parallel guide
- 1 x 45° cutting guide
- 1 x disc guard
- 2 x spanners
- 1 x push stick
- operating instructions

If any parts are missing or damaged, please contact your dealer

TECHNICAL DATA

Voltage	230-240V~50Hz
Input power	800W (S2 : 10 min)
No load speed	2950/min
Max cutting depth	45mm
Bevel degree	0-45°
Blade size	Ø200x16x2.4mm
Table Size	500 x 335 mm
Weight	10.8kg

NOISE INFORMATION

A weighted sound pressure	96.6dB(A)
A weighted sound power	109.6dB(A)
K _{PA} & K _{WA}	3.0dB(A)
Wear ear protection when sound pressure is over	80dB(A) 

ORIGINAL INSTRUCTIONS

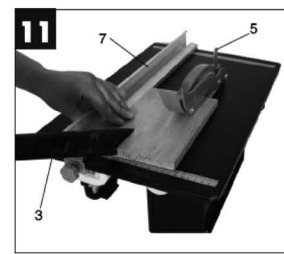
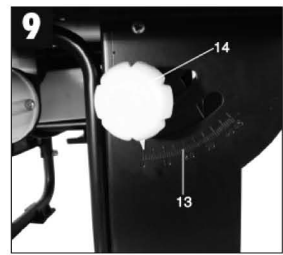
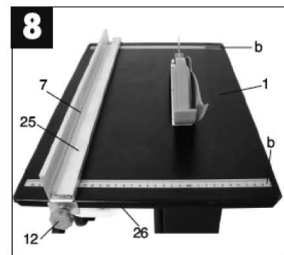
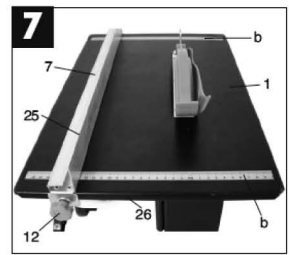
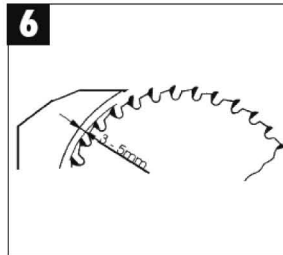
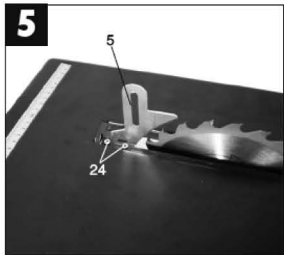
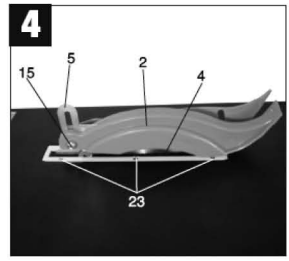
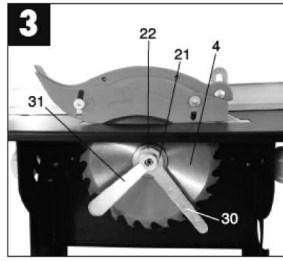
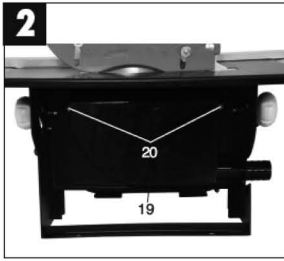

ASSEMBLY

Before any adjustment or assembly, make sure the power plug is pulled disconnected

Replacing the saw blade (Fig. 2/3)



Caution! Pull out the power plug.

- Unscrew the fixing screws (20) and remove the lower blade guard (19).
- Undo the nut (21) with a ring wrench (30) on the nut itself and the spanner (31) on the saw shaft to apply counter-pressure.
- Caution! Turn the nut in the direction of rotation of the saw blade (4).
- Take off the outer flange (22) and pull the old saw blade (4) off the inner flange by dropping the blade at an angle.
- Clean the mounting flange.
- Fit the new saw blade in reverse order.
- Caution! Note the direction of rotation (see arrow on the saw blade).

Adjusting the splitter (Fig. 4-6)

- Remove the saw blade guard (2)
- Take out the table insert (6)
- Slacken the two hexagon socket-head screws (24).
- Adjust the splitter (5) so that the gap between the saw blade (4) and the splitter (5) equals 3 - 5 mm (see Fig. 6)
- The splitter (5) has to be in line with the saw blade (4) in longitudinal direction.
- Retighten the two screws (24).
- The setting of the splitter has to be checked each time after changing the saw blade.

Fitting the saw blade guard (Fig. 4)

- Mount the saw blade guard (2) on the splitter (5) and align.
- Insert the screw (15) through the hole in the saw blade guard (2) and in the splitter (5) and secure it with the nut.
- To remove the saw blade guard, proceed in reverse order.

Parallel guide

1. cutting depth (Fig. 7/8)

- (1) The parallel guide (7) supplied with the table saw has two different guide faces. For thick material you must use the guide (25) as shown in Fig. 7, for thin material you must use the guide as shown in Fig. 8.
- (2) To change the height of the guide, slacken the two knurled screws (12) and pull it off the carrier rail.
- (3) Turn the guide rail (25) 180° to the left or the right, depending on the required guide face, and place it back on the carrier rail (26).
- (4) Re-tighten the knurled screws (12).

2. Cutting width (Fig. 8)

1. The parallel guide (7) must be used when making longitudinal cuts in wooden workpieces.
2. Slide the parallel guide (7) to the right or left side of the saw table (1).
3. The parallel guide (7) can be set to the dimension with the help of the scale (b) engraved on the saw table (1).
4. Tighten the two locking knobs (12) in order to fix the parallel guide (7).

Adjusting the cutting angle (Fig. 9/10)

1. Slacken the star-grip screws at the front and back on the unit. (14).
2. You can now adjust the blade (4) to the required angle (see scale (13)) by sliding the two star-grip screws (14).
3. Re-tighten the star-grip screws (14).

OPERATION

On/Off switch(Fig. 1)

Your table saw is equipped with a magnetic switch located on the front of the machine.

Press "I" (green button) to turn the cutter ON and the "O" (red button) for Off.

Wait until the disc is running at full speed before cutting.

The switch is a safety switch, which will be cut off if electricity suddenly cuts off during operation. Once the electricity is on, the machine will not restart due to the safety switch. You need to repress the "I" (green button) to activate the table saw again.

Plain cuts (Fig. 11)

1. Adjust the parallel guide (7) to the width of work piece you require.
2. Feed in the work piece with two hands. Always use the push stick (3) in the area of the saw blade (4). (A push stick is supplied with the saw!)
3. Always push the work piece through to the end of the splitter (5).
4. Caution! With short work pieces, use the push stick from the beginning.

Diagonal Cuts (Fig 12)

The 45° cutting guide is used for diagonal cuts.

1. Set the parallel guide to the required distance. Be aware the minimum guide distance is 10cm to make space for the cutting guide.
2. Place the 45° cutting guide against the parallel guide.
3. Push the tile and cutting guide to make the diagonal cut as in below picture

Mitre cuts

1. Set the parallel guide to the required distance.
2. Set the cutting angle to the required angle.
3. Follow the same procedure for a plain cut. Ensure that the work piece is held firmly into the guide before making the cut.

DUST EXTRACTION (Fig 13)

The Table Saw is fitted with a dust extraction outlet located at the rear of the saw (Fig.13) .

To use simply attach a vacuum cleaner or dust collector hose to the outlet.

MAINTENANCE

Keep the ventilation openings clear and clean the product regularly.

If something unusual occurs during use, switch off the supply and disconnect the plug.

Inspect and repair the tool before using it again.

The repairs must be carried out by a qualified technician.

Repair of the tool must only be carried out by a qualified repair technician.

Repair or maintenance by unqualified personnel can lead to a risk of injury.

Use only identical spare parts for repairing a tool. Follow the instructions in the maintenance section of this user manual.

Caution!

If the replacement of the supply cord is necessary, this has to be done by the manufacturer or his agent in order to avoid a safety hazard.

Care and cleaning

Clean the housing only with a damp cloth-do not use any solvents! Dry thoroughly afterwards.

PLUG REPLACEMENT

Your Power Tool is supplied with a fitted plug, however if you need to fit a new plug follow the instruction below.

IMPORTANT

The wires in the mains lead are coloured in accordance with the following code:

Blue - Neutral Brown - Live

As the colours of the wires in the mains lead of this appliance may not correspond with the coloured markings identifying the terminals in your plug, proceed as follows.

The wire which is coloured blue must be connected to the terminal which is marked with **N**

The wire which is coloured brown must be connected to the terminal which is marked with the letter **L**. If a 13AMP (BS1363/A) plug is used, a 13A fuse must be fitted, or if any other type of plug is used a 13AMP fuse must be fitted, either in the plug or adapter, or on the distribution board.

Note: If a moulded plug is fitted and has to be removed take great care in disposing of the plug and severed cable, it must be destroyed to prevent engaging into a socket. If the supply cord is damaged it must be replaced by a service agent or a similarly qualified person in order to avoid hazard.

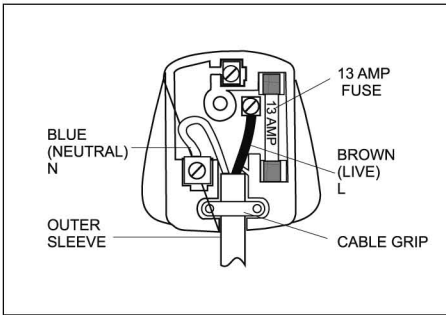

Note: If a moulded plug is fitted and has to be removed take great care in disposing of the plug and severed cable, it must be destroyed to prevent engaging into a socket.

If the supply cord is damaged it must be replaced by a service agent or a similarly qualified person in order to avoid hazard.

DISPOSAL



Do not dispose of electrical appliances with your domestic waste!

The packaging comprises exclusively environmentally- friendly material. Dispose of it in your local recycling containers.

GUARANTEE

This product is selected for DOMESTIC USE ONLY and not for business use. This product is guaranteed against manufacturing defects for a period of 12 months. This does not cover the product where the fault is due to misuse, abuse, use in contravention of the instructions, or where the product has been the subject of unauthorised modifications or alterations, or has been the subject of commercial use. In the event of a problem with the product within the guarantee period please contact the service centre for assistance on 08454 505299. If the item is shown to have an inherent defect present at the time of sale, you will be provided with a replacement. Your statutory rights remain unaffected.

Guarantor: Home Retail Group, MK9 2NW

Argos Ltd

489-499 Avebury Boulevard
Saxon Gate West
Milton Keynes
Buckinghamshire
MK9 2NW

We hereby certify that the product stipulated above complies with all the relevant provisions of the following EC new approach directive/s.

This declaration of conformity is issued under the sole responsibility of the manufacturer

Type of Product: 800W Table Saw

Model Number: TS200/800C2
Cat / Article Number: 7113983

Product Description:

Photograph:

Voltage: 230-240V~50Hz
Input power: 800 W (S2 : 10 min)
No load speed: 2950/min
Max cutting depth: 45mm
Bevel degree: 0-45°
Blade size: Ø200x16x2.4mm
Table Size: 500 x 335 mm
Weight: 10.8kg



Applicable EC Directives		
--------------------------	--	--

<input checked="" type="checkbox"/>	2006/42/EC (MD)	<input checked="" type="checkbox"/>	2004/108/EC (EMC)	<input type="checkbox"/>	1999/5/EC (R&TTE)
<input checked="" type="checkbox"/>	2006/95/EC (LVD)	<input type="checkbox"/>	2009/105/EC (Pressure)	<input checked="" type="checkbox"/>	2000/14/EC Annex , 2005/88/EC
<input type="checkbox"/>	2009/125/EC (ErP)	<input type="checkbox"/>	2009/48/EC (Toys)	<input type="checkbox"/>	L _{WA} =96.6dB(A), L _{PA} = 109.6dB(A), K=3dB(A)
<input type="checkbox"/>	2009/142/EC (Gas)	<input type="checkbox"/>	89/106/EEC (Construction)	<input type="checkbox"/>	/ /EC (Others)

Applicable Harmonized Standards:	Report Date	Verification of conformity Certificate	Notified Body
EN 61029-1/A11: 2010 EN 61029-2-1: 2010	2011.12. 22	GS	TUV
EN 55014-1/A1: 2009 EN 55014-2/A2: 2008 EN 61000-3-2/A2: 2009 EN 61000-3-3: 2008	2011.12. 30	EMC	TUV
EC Type approval certificate number			

Issued number: 1.0

Issued on : 2012-6-26

Signed : *R. Pantone-Kent*

Creator: Max Shi

Name : Roger Pantone-Kent

Position: QA

Position: Head of Quality Assurance