

41cm PETROL HAND PUSH LAWNMOWER XSS41A

CAUTION

These instructions contain important information that will help you get the best from your lawnmower, ensuring it is assembled correctly and safely. If you need help or have damaged or missing parts, call the Customer Helpline on 0844 856 0793

Do you need help with this product?
Instead of returning your product please call our
technical helpline on 0844 856 0793





Warning: Read this instruction manual
carefully before using the product.

41cm Petrol Hand Push Lawnmower XSS41A

Safety information	01
In the box	05
Assembly	06
Preparing to operate the lawnmower	06
Operate	10
How to replace the blade	13
Technical data	14
Maintenance	15
Guarantee	19
CE-Description	20

The following warning symbols appear throughout this assembly manual and indicate the appropriate safety measures you should take when assembly and operating the lawnmower.

 This symbol indicates there is a danger of serious personal injury or death if you do not observe the warning.

 This symbol indicates that there is a danger of damaging your hands if you do not wear thick, hard wearing gloves.

 **WARNING!** Keep this assembly manual in a safe place following assembly for reference at a later date.

WARNING! Always ensure anyone intending to operate this lawnmower is fully conversant with the contents of this assembly manual prior to assembling, maintaining or operating the lawnmower.

WARNING! Perform assembly operations as described in this manual. Failure to observe this warning may lead to serious injury, death, or damage to the lawnmower.

WARNING! Always take care when removing the packaging to prevent damage to you or to the lawnmower.

 **IMPORTANT!** Before assembling the lawnmower, check all the parts indicated in the manual are in the box. Inspect all the parts for signs of damage. Do not assemble the lawnmower if you observe any damaged components.

 **NOTE!** This lawnmower complies with the Noise Emission Directive 2000/14/EC.

 **WARNING!** Only operate the lawnmower if you are wearing the correct Personal Protective Equipment (PPE) as described in the following warnings.

 **WARNING!** Always wear suitable gloves when operating lawnmower to protect your hands from flying debris and/or sharp objects.

Warning Symbols

The following warning symbols appear throughout this manual and indicate the appropriate safety measures you should take when operating and maintaining the lawnmower.



Read instruction handbook before operating this machine.



Keep bystanders away.



Beware of sharp blades- remove spark plug lead before maintenance.



No naked flames.



Appropriate ear, eye, and head protection must be worn.



Hot surfaces will burn fingers or palms.



Warning! The lawnmower exhaust gas contains toxic substances. Do not run the engine in closed or poorly ventilated areas.



Blade continues to rotate for a period after the machine is switched off. Do not touch the blade until all the machine components have been stopped completely.

General Safety Instruction



WARNING!

Important - Please read these instructions fully before starting assembly

1. **WARNING!** Keep this operating and maintenance manual in a safe place for reference at a later date.
 2. **WARNING!** Read the instructions carefully. Be familiar with the controls and the proper use of the equipment.
 3. **WARNING!** Never allow children or people unfamiliar with these instructions to use the lawnmower. Local regulations can restrict the age of the operator.
 4. **WARNING!** Never mow while people, especially children, or pets are nearby. Keep in mind that the operator or user is responsible for accidents or hazards occurring to other people or their property.
 5. **WARNING!** This appliance is not intended for use by people (including children) with reduced physical, sensory or mental capabilities, or lack of experience and knowledge, unless they have been given supervision or instruction concerning use of the appliance by a person responsible for their safety.
- WARNING!** Do not touch rotating blade.

Preparation

- a) While mowing, always wear substantial footwear and long trousers. Do not operate the equipment when barefoot or wearing open sandals;
- b) Thoroughly inspect the area where the equipment is to be used and remove all objects which can be thrown by the machine;
- c) **WARNING!** Petrol is highly flammable: store fuel in containers specifically designed for this purpose;
 - refuel outdoors only and do not smoke while refueled;
 - add fuel before starting the engine. Never remove the cap of the fuel tank or add petrol while the engine is running or when the engine is hot;
 - If petrol is spilled, do not attempt to start the engine but move the machine away from the area of spillage and avoid creating any source of ignition until petrol vapours have dissipated;
 - replace all fuel tank and container caps securely;
- d) Replace faulty silencers;
- e) Prior to use, visually inspect to see that the blade, blade bolts and cutter assembly are not worn or damaged. Replace worn or damaged blades and bolts in sets to preserve balance;

Operation

- a) Do not operate the engine in a confined space where dangerous carbon monoxide fumes can collect;
- b) Mow only in daylight or in good artificial light;
- c) Avoid operating the equipment on wet grass, where feasible;

- d) Always be sure of your footing on slopes;
- e) Walk, never run;
- f) Mow across the face of slopes, never up and down;
- g) Exercise extreme caution when changing direction on slopes;
- h) Do not mow excessively steep slopes;
- i) Use extreme caution when reversing or pulling the lawnmower towards you;
- j) Stop the blade if the lawnmower has to be tilted for transportation when crossing surfaces other than grass, and when transporting the lawnmower to and from the area to be mowed;
- k) Never operate the lawnmower with defective guards, or without safety devices, for example deflectors and/or grass catchers, in place;
- l) Do not change the engine governor settings or over speed the engine;
- m) Start the engine carefully according to instructions and with feet well away from the blade;
- n) Do not tilt the lawnmower when starting the engine;
- o) Do not start the engine without the grass collector located;
- p) Do not put hands or feet near or under rotating parts. Keep clear of the discharge opening at all times;
- q) Never pick up or carry a lawnmower while the engine is running;
- r) Stop the engine and disconnect the spark plug cable, making sure that all moving parts have come to a complete stop:
 - Before clearing blockages or unclogging chute;
 - Before checking, cleaning or working on the lawnmower;
 - After striking a foreign object, inspect the lawnmower for damage and make repairs before restarting and operating the lawnmower;
 - If lawnmower starts to vibrate abnormally, check immediately;
- s) Stop the engine and disconnect the spark plug wire, make sure that all moving parts have come to a complete stop before refueling;

Maintenance and Storage

- a) Keep all nuts, bolts and screws tight to be sure the equipment is in safe working condition;
- b) Never store the equipment with petrol in the tank inside a building where fumes can reach an open flame or spark;
- c) Allow the engine to cool before storing in any enclosure;
- d) To reduce the fire hazard, keep the engine, silencer, battery compartment and petrol storage area free of grass, leaves, or excessive grease;
- e) Check the grass bag frequently for wear or deterioration;
- f) Replace worn or damaged parts for safety;
- g) If the fuel tank has to be drained, this should be done outdoors.

Parts List

Parts Tools

- A Main mower deck (with upper handle attached)
- B Lower handle
- C Self-tapping screws 2pcs
- D Handle tensioning knob with nut m8 2pcs
- E Rope guide 1pc
- F Grass collecting bag 1pc
- G Cable clip 1pc
- 1 Spanner & Philips screwdriver 1pc

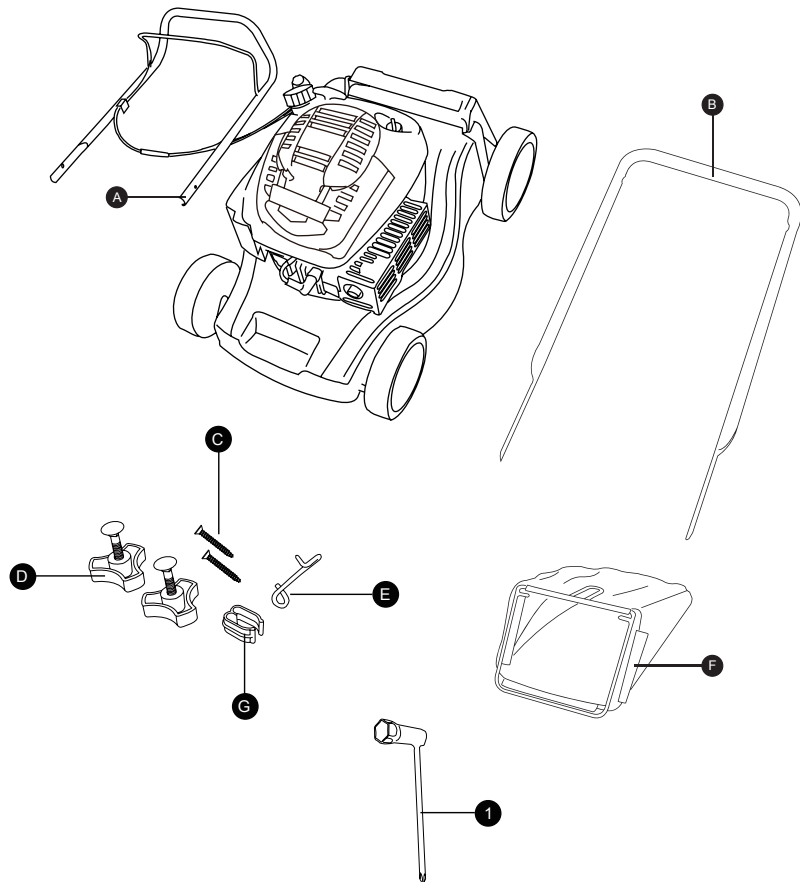

Preparing to assemble the lawnmower



WARNING! Always take care when removing the packaging to prevent damage to you or to the lawnmower.



IMPORTANT! Before assembling the lawnmower, check all the parts indicated in the manual are in the box. Inspect all the parts for signs of damage. Do not assemble the lawnmower if you observe any damaged components.

1. Remove all parts of the lawnmower from the box and carefully remove all packaging. Take care not to lose any instructions which may be affixed to the parts. These provide important information which will be required while assembling the lawnmower.
2. Keep all packaging until the lawnmower is fully assembled and has been operated successfully.



NOTE! Always recycle the packaging in accordance with local recycling schemes.



WARNING! This item requires a two person lift to remove from the packaging. Make sure that you have sufficient space to put the lawn mower down. Keep your feet apart so that you have a stable position, bend at the knees and keep your back straight.

Step 1 - Assemble the lower handle

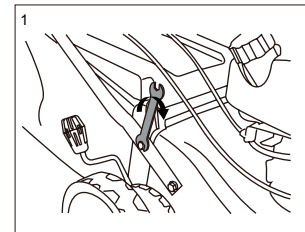

Remove the packaging from the handle.

Align the lower handle with the holes in the deck. Fix the lower handle onto the deck firmly with supplied wrench.

Step 2 - Assemble the upper handle

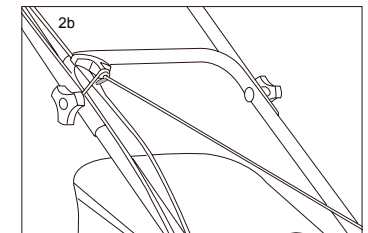
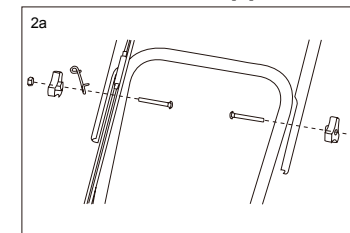

2a Lift the upper handle, align it with the lower handle, making sure the cables are not twisted, and fasten the two handles together by using the bolts and handle tension knobs included in box.

2b Make sure the rope guide is on right hand side with the 90° bend on top of the handle, when you stand behind the mower.

 **CAUTION!** Make sure the lower and upper handles are firmly connected

Step 3

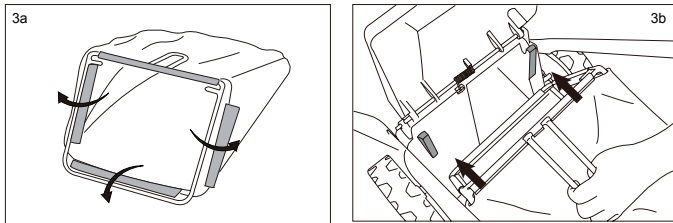

3a. Firstly attach the grass bag to the frame by fixing all plastic hooks.
 3b. Raise the safety flap, and hook the collection bag onto the mower. Release the safety flap.

 **NOTE!** Always fit the grass collection bag before starting the engine.

Step 4

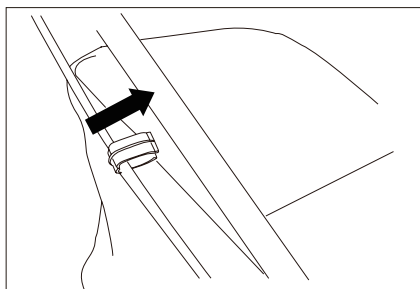

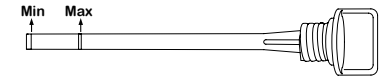
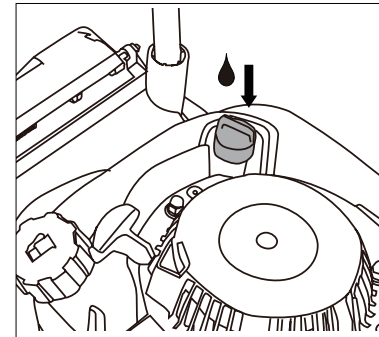

4. Ensure that the cable clips supplied are used to fix the cable to the Lower Handle.

Step 1 - Filling with Engine Oil



 **CAUTION!** The following procedures and adjustments must be performed before the engine is started. Do not attempt to make any of these adjustments while the engine is running.

 **CAUTION!** Always use high quality detergent oil classified SAE30 oil (or equivalent eg 5W 30, Often termed as 4 Stroke lawn mower oil). Never use additives with recommended oil. To prolong the life of your engine it is important that the oil is changed after the first 5 hours of use.

 **CAUTION!** To prevent engine damage the engine is shipped without oil or petrol. The engine must be filled with the correct grade of oil and petrol before starting the engine.

 **NOTE!** Running the engine with a low oil level will cause engine damage. It is recommend that a high detergent, premium quality 4-stroke engine oils is used. Using non-detergent oil can shorten the engine's service life and using 2-stroke oil will damage the engine.

Check the engine oil level with the engine stopped and the mower on a level surface. Remove the oil filler dipstick and wipe oil from it with a clean cloth. Insert the dipstick into the oil filler neck, but do not screw it in. Check the oil level. The oil level must be between the Min and Max marks on the dipstick. If near the lower level, fill to upper level with the recommended oil (SAE30 or equivalent). Do not overfill. Wipe away any spilt oil.

Step 2 - Filling with Engine Fuel

CAUTION! Always use clean, fresh unleaded petrol. Purchase fuel in quantities that can be used within 30 days. Never mix oil with petrol.

CAUTION! Do not fill into the base of neck to allow for fuel expansion. Do not overfill the fuel tank.

WARNING! Petrol is highly flammable and extreme precaution must be taken when handling or working with it. Keep out of reach of children.

CAUTION! To prevent engine damage the engine is shipped without oil or petrol. The engine must be filled with the correct grade of oil and petrol before starting the engine.

WARNING! Refuel in a well-ventilated area with the engine stopped. Do not smoke or allow flames or sparks in the area where the engine is refueled or where petrol is stored.

Avoid repeated or prolonged contact with skin or breathing of Vapour.

Clean the area around the petrol filler cap before removing the cap.

Remove the warning tag, check the fuel level.

Refill the tank if the fuel level is low.

Refuel carefully to avoid overfilling or spilling fuel. There should be no fuel in the filler neck.

Clean up any overflow or splashes of petrol before starting the engine

Refit the filler cap after filling

Step 1 - Setting the Cutting Height

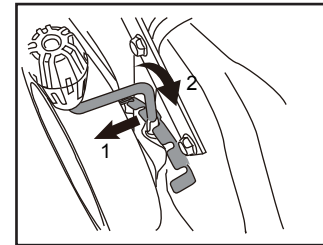

WARNING! The blade can cause serious injury. Before adjusting the mower height, stop the engine and wait for the mower to completely stop.

IMPORTANT! Adjust the cutting height:

- Pull the lever towards the wheel;
- Move the lever to the position that gives the desired cutting height (25 mm to 75 mm)
- Release lever towards mower deck.

Step 2 - Starting the Engine

2a		
PRIMER BULB 3~5 TIMES	STOP/START -LEVER CLOSED	PULL STARTING _KNOB
1 	2 	3

2a Starting procedure quick guide

WARNING! Do not operate the machine in an enclosed or poorly ventilated areas as the exhaust gas contains toxic substances. Keep hands, feet, hair and clothing away from all the moving parts of the machine. The exhaust and other parts of the machine will become hot during use.

Make sure that the blade is securely fastened before starting the engine.

NOTE! To start the engine, make sure that the spark plug cap is located on the spark plug and the machine is filled with sufficient oil and petrol.

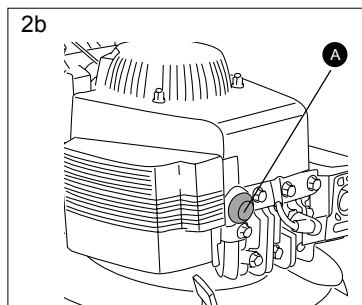

2b Press the primer bulb (A) 3-5 times.

When starting a cold engine, press down the primer fully 3~5 times.



NOTE! The primer is a direct prime system so the primer bubble will not fill with fuel, this is normal.



WARNING! Too many presses on primer may cause engine flooding.

When starting a warm engine, the primer does not need to be used. If the engine stops due to a lack of petrol, refill and press the primer 3~5 times.

2c Start/Stop Bar Activation

Pull the stop / start bar towards the upper handle.

2c Pull cord handle

With right hand, slowly but firmly pull the starter handle and rope from the pull cord guide until you feel resistance, then pull briskly. If the engine fails to start after three pulls, repeat the start process. When the engine starts, return the starter rope to the pull cord guide gently.



NOTE! Clearing a flooded engine

If the engine won't start after you have operated the starter several times, the engine may be flooded with excess fuel.

Use following procedure to clear and start a flooded engine.

- A. Release the stop / start bar.
- B. Remove the spark plug, dry it, and then reinstall it.



NOTE! Install the spark plug carefully by hand, to avoid cross-threading. After the plug is seated, tighten 1/8 to 1/4 turn with socket spanner of spark plug to compress the washer.

- C. Pull the stop / start bar towards the upper handle.
- D. Operate the starter as described above.

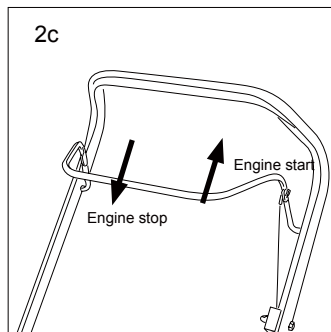

Step 3 – Mowing



WARNING! Always observe the strictest safety procedures when using the lawnmower.

Carefully read the safety instructions of this manual before using the lawnmower.

Start the engine and allow it run .See "Step-2 Starting the engine"

To stop the engine, release the stop / start bar.

Keep a firm grip on the upper handle and walk, never run with the mower, be very careful when mowing uneven or rough ground. Mow across slopes, never up and down. Be careful when changing the direction of the mower on a slope. Do not use the mower on a steep slope of more than 15° .

The best result will be achieved if the grass is dry. Wet grass will tend to clog the blade and the grass collection system. Grass grows at different rates at different time of the year.

Never use the lowest cutting height for the first cut of the season or in drought conditions.

Only about one thirds of the grass height should be cut.

If the lawnmower will not collect the cuttings efficiently, the grass discharge chute may be blocked. The grass bag may be full, or the underside of the mower deck may be clogged.

Step 4 - Emptying the Grass Bag

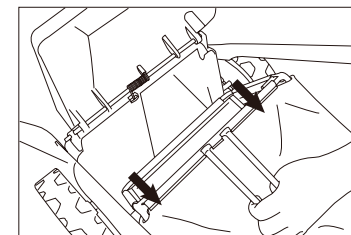

WARNING! Before you remove the grass collection bag, stop the engine and wait until the blade stops completely.

WARNING! Always empty the grass bag when you have finished the mowing, even if it is not full.

Stored grass residues are a fire hazard.

To remove the grass collection bag, raise the discharge flap with one hand and remove the grass bag using its handle with your other hand.

To maintain safety, the discharge flap will close back to cover the rear discharge chute, when you release the flap.

Empty the grass debris in the grass collection bag, and refit grass collection bag.

If any grass residue is caught in the discharge chute, clean it using a brush.

Do not remove grass debris in the mower casing or on the blade by hand or with your feet. Instead use suitable tools such as a brush or broom.

To ensure that the cut grass can be collected into grass collection bag, the discharge opening and inside the mower casing must be cleared of any blockage.

Replacing the Blade

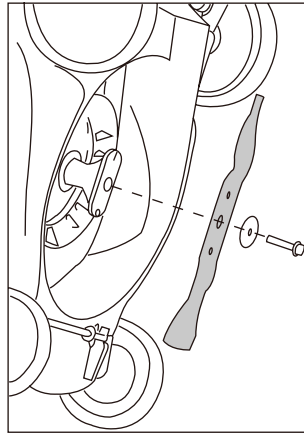

WARNING! Before you remove the grass collection bag, stop the engine and wait until the blade stops completely.

WARNING! You will need garden gloves (not provided) and a spanner wrench to remove the blade.

NOTE Don't invert the mower. Tip it slightly towards the oil filler pipe and reach under the deck.

WARNING! Always handle the blade with care- sharp edges could cause injury USE GLOVES.
Renew your metal blade after 50Hrs mowing or 2yrs which ever is sooner regardless of condition.

WARNING! If the blade is cracked or damaged replace it with a new one.

WARNING! Don't hold the blade by hand directly.

NOTE Maintain the sharpness of the blade when cutting grass. If the blade has worn excessively and become pitted and blunt, it should be replaced or sharpened. The sharpness of the blade will affect the performance of the lawnmower. For safety reasons we recommend that the blade will only be changed by persons qualified and authorised to do so.
Hold the blade and unscrew the blade bolt counterclockwise using a spanner wrench. Remove the washer and the blade.
Fit a new blade or re-sharpen the blade, locate the blade on the two studs on the blade flange and then replace the washer and bolts. Make sure the blade is correctly located, and then firmly tighten the bolt. Do not over tighten. The up turn of the blade must project into the motor compartment.

Technical Data

- Engine type Single cylinder 4-stroke
- Engine displacement 149.3cc
- Engine max.power 2.1kW / 3600 rpm
- Engine speed 3000rpm
- Cutting width 41cm
- Grass bag capacity 45L
- IgnitionT.C.I
- Fuel tank capacity 0.8L
- Oil tank capacity 0.6L
- Sound pressure level 85 dB(A)
- Sound power level 96 dB(A)
- Vibration 3.7m/s²
- Spark type QJ19LM
- Net weight 24.5kg

Troubleshooting

WARNING! Always switch off the engine and pull the ignition cable before starting any inspection or adjustment work.

WARNING! If, after making an adjustment or repair to the engine, you let it run for a few minutes, remember that the exhaust and other parts will get hot. Thus, do not touch parts that emanate heat, as these may burn you.

The following table provides solutions to common problems encountered with the lawnmower.

Fault	Possible Cause	Solution
Loud while running, machine vibrates heavily	- Screws are loose - Blade fasteners are loose - Blade is unbalanced	- Check screws - Check blade fasteners - Replace blade
Engine does not start	- start/stop bar not pressed - Primer bulb is empty - Spark plug is defective - Fuel tank is empty - Engine may be flooded	- Press start/stop bar - Press primer bulb 3~5 times. - Replace spark plug - Refill with fuel - remove plug and dry
Engine runs unsteadily	- Air filter is soiled - Spark plug is soiled	- Clean the air filter - Clean the spark plug
Uneven mowing results	- Blade is blunt - Cutting height is too low	- Sharpen the blade - Set correct height
Unsatisfactory bagging of the grass	- Cutting height is too low - Blade is worn - grass bag is clogged	- Set correct height - Replace the blade - Empty the grass bag

Storing the Lawnmower Maintenance

Step 1 - Storing the Lawnmower for Short Periods Maintenance

The lawnmower can be stored for short periods of time (less than 15 days) without performing any storage maintenance.

Before placing the lawnmower into storage always carry out the following:

- Allow the engine to fully cool.
- Ensure the grass bag is empty.
- Clean all debris under the mower deck.
- Store the lawnmower on flat and level surface with the mower upright.
- Store in a safe place which is not accessible by children or people who are not familiar with operation.

Step 2 - Storing the Lawnmower for Extended Periods

If the lawnmower is to be placed into storage for more than 15 days, storage maintenance must be performed on the lawnmower. If the following steps are not carried out, when you next operate the lawnmower it may not start correctly and may need to be serviced.



CAUTION! Do not empty the petrol tank in enclosed areas, near fire or when smoking. Petrol fumes can cause explosions and fire.

2a Empty the petrol tank with a petrol suction pump if available.

2b Start the engine and let it run until any remaining petrol has been used up.

2c Change the oil at the end of every season. To do so, remove the used engine oil from a warm engine and refill with fresh oil.

2d Remove the spark plug from the cylinder head. Fill the cylinder with approx. 20 ml of oil from an oil can. Slowly pull back the starter handle, which will bathe the cylinder wall with oil. Screw the spark plug back in.

2e Clean the cooling fins of the cylinder and the housing.

2f Be sure to clean the entire machine to protect the paint.

2g Store the machine in a well-ventilated place.

Maintenance Schedule

Performing routine maintenance correctly on your lawnmower will ensure you get years of trouble free use.

Please keep this manual safe for future reference.

It is recommended that the following maintenance schedule is adhered to. This will ensure the lawnmower operated correctly and is safe to use.

	12 hours of use	24 hours of use	36 hours of use
Air filter	clean	clean	replace
Spark plug	check	clean	replace
Engine oil	check	replace	check

The Engine oil should be changed after the first 8 hours.

Step 1 - Cleaning



NOTE! To ensure the best performance of your lawnmower, it is important to keep it clean. Always clean your lawnmower immediately after use.



WARNING! Do not allow grass cuttings and other debris to become dry and hard on any of the mower surface. This will directly affect the cutting and grass collection performance. Make sure that the underside of the lawnmower deck is clean and clear.



WARNING! Never turn the mower upside down.



IMPORTANT! Before you tip the lawn mower onto its side, completely empty the fuel tank using a petrol suction pump.



WARNING! Never clean the lawn mower with a water jet or high-pressure cleaner. The engine must remain dry. Do not use aggressive cleaning agents such as cold cleaner or petroleum ether.

Step 1 - Cleaning (continued)

1a The lawn mower should be thoroughly cleaned after every use, especially the underneath and the blade mount.

To do so, tip the lawn mower onto its left side (the opposite side to the oil filling socket).

Dirt and

grass is easiest to remove immediately after you have finished mowing the grass.

1b Check that the grass chute is free of any residual grass. Remove any such residue.

Step 2 - Cleaning or Replacing Spark Plug

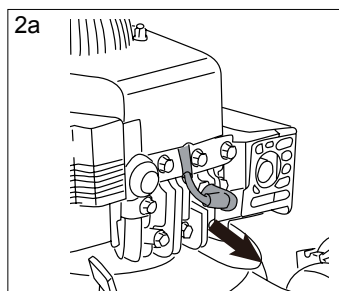

2a Once the engine has cooled, pull off the spark plug boot with a twist. Remove the spark plug using the socket spanner supplied.

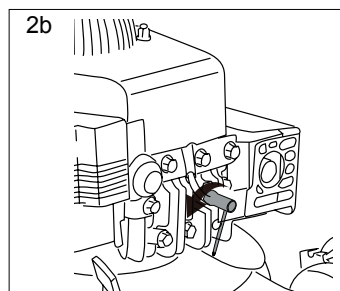

2b Clean the plug with a wire brush.

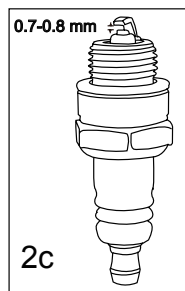

2c Using a feeler gauge set the gap to 0.75mm.

2d Install the spark plug carefully by hand, to avoid cross-threading.

2e After the spark plug is seated, tighten with the spanner to compress the washer.

Step 3 - Cleaning or Replacing Air Filter

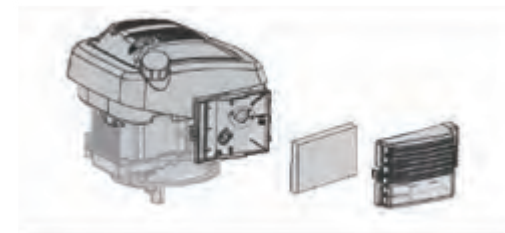

WARNING! Never run the engine without the air filter element installed.

3a Unclip the air filter cover and remove the sponge filter element.

To avoid objects falling into the air tank, replace the air filter cover. Wash the filter element in warm soap water, rinse and allow drying naturally.

3b After cleaning, it needs to be moistened with oil then squeezed dry. The oil film in the foam can prevent debris and dust from entering the engine.

Step 4 - Changing the Oil

Tilt the lawnmower towards the oil filler, have a container ready to catch the oil and remove the dipstick. Once the oil has been emptied, replace the dipstick and wipe clean any spillages.

Refill with 600ml SAE30 oil or equivalent ie SAE5W/30, SAE10W/30). When the dipstick is rested on the filler pipe (i.e. not screwed in place), the oil level must be between the min and max marks on the dipstick.

See "Filling with Engine Oil". Do not overfill.

Start the engine and allow it run briefly.

Stop the engine, wait one minute and check the oil level. Top up if necessary.



NOTE! See more in Engine Manual.

Step 5 - Blades

For safety reasons you should only ever have your blade sharpened, balanced and mounted by an authorized service workshop. For optimum results it is recommended that the blade should be inspected once a year.



NOTE! For engine maintenance, see more details in Operating Manual.

Thank you for purchasing a RYNO garden tool. In the unlikely event that your product develops a fault, please contact our team of technical experts at Core Service, the aftersales department, on 0844 856 0793 who will aim to resolve any faults over the phone for you.

This product is guaranteed for 1 year from the original date of purchase; the guarantee applies to material and manufacturing defects. These guarantee terms cover additional guarantee rights and do not affect your statutory rights. If the defect is covered by our guarantee your product will either be refunded in full, or replaced. Guarantee claims should be submitted within the 12 month guarantee period after which no claims will be accepted.

Please note that our products are for DIY use only and are not designed for use in commercial, trade or industrial applications. Consequently, the guarantee is invalidated if the equipment is used in commercial, trade or industrial applications or for other equivalent activities. This product must be used in accordance with the instructions contained in this manual. The guarantee will be rendered invalid if the product has been damaged by unauthorised repairs or resold.

The following are also excluded from the guarantee:

- A) Faults due to accidents, customer misuse, or unauthorized repairs
- B) Consumable parts and accessories such as blades/spark plugs or filters
- C) Failure due to lack of routine maintenance
- D) Failure as a result of not using the equipment in accordance with the manual and safety instructions
- E) The adjustment of cables, drive belts or recoil starters

Please keep your proof of purchase in a safe place; this warranty is not valid without the original dated proof of purchase.

Core Service

Technical helpline: 0844 856 0793
 Email: support@coreservice.co.uk
 Website: www.coreservice.co.uk



EC Declaration of Conformity

Company CDS (Superstores International) Limited
Address Tamar House,
 Thornbury Road,
 Estover,
 Plymouth
 PL6 7PT
Product Petrol Lawnmower
Model Number Ryno XSS41A, XSZ41A

Note XSS41A is pushed type. XSZ41A is self-propelled.
 We hereby declare the above product complies with the essential health and safety requirements of the following directives:

- 2006/42/EC - Machinery Directive**
- 2000/14/EC and 2005/88/EC - Outdoor Noise Directive**

Engine Displacement: 149.3cm³
Motor Power: 2.1Kw
No Load Speed: 3000/min
Cutting Width: 410mm
XSS41A Weight: 24.5Kg
XSZ41A 26.5kg

The grass cutting machine meets the provisions and complies with the standards and technical specifications of:

EN 836:1997+A4:11, EK9-BE-52:2007, EK9-BE-34:2004
ISO 11094:91, EN ISO 3744:1995

Measured sound power level: Max.93 dB (A)

Guaranteed sound power level: 96 dB (A)

Conformity assessment method to Annex III of 2000/14/EC as amended by 2005/88/EC

The technical documentation for the machinery is available from:

Name: Tim Davies
Address: Tamar House, Thornbury Road, Estover, Plymouth PL6 7PT

Authorized Signatory;

Name: Tim Davies

Position: Technical Manager

Date: 2014-01-09

Location: Plymouth

CDS (Superstores International) Limited

