

**PowerG<sup>®</sup>**

**14.4V Cordless Drill**

**PG14CD-1**



**Manufacturer: SUMEC Hardware & Tools Co., Ltd**  
**1# Xinghuo Road, National level Nanjing High-Tech Zone,**  
**Nanjing 210061 P.R. China**

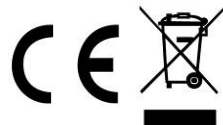

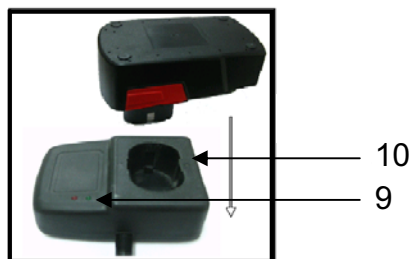







## TECHNICAL DATA

Cordless Drill		PG14CD-1
Rated voltage		DC 14.4V
No-load speed		650 rpm
capacity	Steel	8 mm
	Wood	10 mm
<b>Battery</b>		Ni-Cd
Battery capacity		1000 mAh
Battery charging time		3-5hours
<b>Battery charger</b>		
Input voltage		230-240 V 50 Hz
Output voltage		DC 18V 400mA
Sound pressure level (LpA)		75dB(A) KpA=3dB(A)
Power sound level (LwA)		86dB(A) KwA=3dB(A)
Vibration		< 2.5m/s <sup>2</sup>

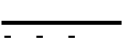
# DESCRIPTION OF SYMBOLS



Please read all of the safety and operating instructions carefully before using this tool. Please pay particular attention to all sections of this User Guide that carry warning symbols and notices.

	Observe caution and safety notes!
$n_0$	No-load speed.
$V\sim$	Voltage
$mA$ $A/Ah$	Milliamps/Amps/Amp-hours
	DC (current and voltage type)
	Drill setting (torque Preselect )
	Protect electrical power tool from moisture!
	Check that the device, mains lead and plug are in good condition!
	Safety class II
	Dispose packaging and appliance in an environmentally -friendly way!

# GENERAL SAFETY INSTRUCTIONS



## WARNING!

**Read all safety warnings and all instructions.** Failure to follow the warnings and instructions may result in electric shock, fire and/or serious injury.

**Save all warnings and instructions for future reference.**

The “power tool” in this instruction refers to your battery-operated (cordless) power tool.

### 1) Work area safety

- a) **Keep work area clean and well lit.** Cluttered or dark areas invite accidents.
- b) **Do not operate power tools in explosive atmospheres, such as in the presence of flammable liquids, gases or dust.** Power tools create sparks which may ignite the dust or fumes.
- c) **Keep children and bystanders away while operating a power tool.** Distractions can cause you to lose control.

### 2) Electrical safety

- a) **The charger’s plug must match the outlet. Never modify the plug in any way. Do not use any adapter plugs with earthed (grounded) power tools.** Unmodified plugs and matching outlets will reduce risk of electric shock.
- b) **Use battery operated tool only with specifically designated battery pack.** Use of any other batteries may create a risk of fire.
- c) **Do not expose power tools to rain or wet conditions.** Water entering a power tool will increase the risk of electric shock.
- d) **Do not abuse the cord. Never use the cord for carrying, pulling or unplugging the power tool. Keep cord away from heat, oil, sharp edges and moving parts.** Damaged or entangled cords increase the risk of electric shock.

- e) **A battery operated tool with integral batteries or a separate battery pack must be recharged only with the specified charger for the battery.** A charger that may be suitable for one type of battery may create a risk of fire when used with another battery.

### 3) **Personal safety**

- a) **Stay alert, watch what you are doing and use common sense when operating a power tool. Do not use a power tool while you are tired or under the influence of drugs, alcohol or medication.** A moment of inattention while operating power tools may result in serious personal injury.
- b) **Use personal protective equipment. Always wear eye protection.** Protective equipment such as dust mask, non-skid safety shoes, hard hat, or hearing protection used for appropriate conditions will reduce personal injuries.
- c) **Prevent unintentional starting. Ensure the switch is in the off-position before connecting to power source and/or battery pack, picking up or carrying the tool.** Carrying power tools with your finger on the switch or energizing power tools that have the switch on invites accidents.
- d) **Remove any adjusting key or wrench before turning the power tool on.** A wrench or a key left attached to a rotating part of the power tool may result in personal injury.
- e) **Do not overreach. Keep proper footing and balance at all times.** This enables better control of the power tool in unexpected situations.
- f) **Dress properly. Do not wear loose clothing or jewelry. Keep your hair, clothing and gloves away from moving parts.** Loose clothes, jewelry or long hair can be caught in moving parts.
- g) **If devices are provided for the connection of dust extraction and collection facilities, ensure these are connected and properly used.** Use of dust collection can reduce dust-related hazards.

### 4) **tool use and care**

- a) **Do not force the power tool. Use the power tool correctly for your application.** The correct use will do the job better and safer at the rate for which it was designed.
  - b) **Do not use the power tool if the on/off switch is not working correctly .** Any power tool that cannot be controlled with the switch is dangerous and must be repaired.
  - c) **Disconnect the plug from the power source and/or the battery pack from the power tool before making any adjustments, changing accessories, or storing power tools.** Such preventive safety measures reduce the risk of starting the power tool accidentally.
  - d) **Store idle power tools out of the reach of children and do not allow persons unfamiliar with the power tool or these instructions to operate the power tool.** Power tools are dangerous in the hands of untrained users.
  - e) **Maintain power tools. Check for misalignment or binding of moving parts, breakage of parts and any other condition that may affect the power tool's operation. If damaged, have the power tool repaired before use.** Many accidents are caused by poorly maintained power tools.
  - f) **Keep cutting tools sharp and clean.** Properly maintained cutting tools with sharp cutting edges are less likely to bind and are easier to control.
  - g) **Use the power tool, accessories and tool bits etc. in accordance with these instructions, taking into account the working conditions and the work to be performed.** Use of the power tool for operations different from those intended could result in a hazardous situation.
- 5) **Battery tool use and care**
- a) **Recharge only with the charger specified by the manufacturer.** A charger that is suitable for one type of battery pack may create a risk of fire when used with another battery pack.
  - b) **Use power tools only with specifically designated battery packs.** Use of any other battery packs may create a risk of injury and fire.

- c) **When battery pack is not in use, keep it away from other metal objects, like paper clips, coins, keys, nails, screws or other small metal objects, Which can make a connection from one terminal to another.** Shorting the battery terminals together may cause burns or a fire.
  - d) **Under abusive conditions, liquid may be ejected from the battery; avoid contact. If contact accidentally occurs, flush with water. If liquid contacts eyes, additionally seek medical help.** Liquid ejected from the battery may cause irritation or burns.
- 6) **Service**
- a) **Have your power tool serviced by a qualified repair person using only identical replacement parts.** This will ensure that the safety of the power tool is maintained.

## **ADDITIONAL SAFETY WARNINGS**

- 1) **Specific safety rules**
  - Do not let comfort or familiarity impair your judgment always adherence to cordless drill safety rules. If you use this power tool unsafely or incorrectly, you can suffer serious personal injury.**
- a) **Hold tool by insulated gripping surfaces when performing an operation where the cutting tool may contact hidden wiring.** Contact with a “live” wire will make exposed metal parts of the tool “live” and shock the operator.
- b) **Be aware that this tool is always in an operating condition, because it does not have to be plugged into an electrical outlet.**
- c) **Always be sure you have a firm footing.**
- d) **Be sure no one is below when using the tool in high locations.**
- e) **Hold the tool firmly .**
- f) **Keep hands away from rotating parts.**



- g) **Do not leave the tool running. Operate the tool only when hand-held.**
- h) **Do not touch the bit or the work piece immediately after operation; they may be extremely hot and could burn your skin.**
- i) **Some material contains chemicals which may be toxic. Take caution to prevent dust inhalation and skin contact. Follow material supplier safety data.**

## **2) Important safety instructions for charger**

- a) Before using the charger, read all the instructions and cautionary markings on the charger and battery pack as well as the instructions on using the battery pack.
- b) Only charge your batteries indoors as the charger is designed for indoor use only.
- c) **DANGER.** If the battery pack is cracked or damaged in any other way, do not insert it in the charger. There is a danger of electric shock or electrocution.
- d) **WARNING.** Do not allow any liquid to come into contact with the charger. There is a danger of electric shock.
- e) To allow the battery pack to cool down after charging, do not place it in a hot environment such as a metal shed or open trailer left in the sun.
- f) The charger is not intended for any use other than charging the exact type of rechargeable battery pack as supplied with the charger. Any other use may result in the risk of fire, electric shock or electrocution.
- g) The charger and battery pack supplied with it are specifically designed to work together. Do not attempt to charge the battery pack with any other charger than the one supplied.
- h) Do not place any object on top of the charger as it could cause overheating. Do not place the charger near any heat source.
- i) Do not pull on the plug of the charger to disconnect it from the power source.
- j) Make sure that the charger cable is positioned where it will not be stepped on, tripped over or otherwise subjected to damage or stress.

- k) Do not use an extension cord unless it is absolutely necessary. The use of an improper extension cord could cause the risk of fire, electric shock or electrocution.
- l) Do not use the charger if it has been subjected to a heavy knock, dropped or otherwise damaged in any way. Take the charger to an authorized service centre for a check or repair.
- m) Do not disassemble the charger. Take it to an authorized service centre when service or repair is required. Incorrect re-assembly may result in the risk of fire, electric shock or electrocution.
- n) To reduce the risk of an electric shock, unplug the charger from the power supply before attempting to clean it. Removing the battery alone does not reduce the risk.
- o) Do not store or use the tool and battery pack in locations where the temperature may reach or exceed 40<sup>0</sup>C (104<sup>0</sup>C) such as alongside sheds or metal structures in the summer.
- p) The charger is designed for use from a standard household electrical supply (230V-240V). Do not attempt to connect the charger to a different supply.
- q) If you wish to charge a second battery pack, unplug the charger from the mains supply and leave it for at least 15 minutes. After this time you can charge a second battery pack.

### **3) Important safety instructions for battery pack**

- a) The battery pack for this tool has been shipped in a low charge condition. You should charge the battery pack fully before use.
- b) To ensure the longest battery life and best battery performance, always charge the battery when the air temperature is between 18-24<sup>0</sup>C (65-75<sup>0</sup>F). Do not charge the battery pack when the temperature is below 4<sup>0</sup>C(40<sup>0</sup>F), or above 40<sup>0</sup>C (104<sup>0</sup>F).this is important. Failure to observe this safety rule could cause serious damage to the battery pack.
- c) Do not incinerate the battery pack even if it is seriously damaged or can no

longer hold a charge. The battery pack can explode in a fire.

- d) A small leakage of liquid from the battery pack may occur under extreme usage or temperature conditions. This does not necessarily indicate a failure of the battery pack .however, if the outer seal is broken and this leakage comes into contact with your skin:

----wash the affected area quickly with soap and water.

----neutralize the liquid with a mild acid such as lemon juice or vinegar.

If the leakage gets in your eyes:

----flush your eyes with clean water for a minimum of 10 minutes and seek immediate medical attention. Inform the medical staff that the liquid is a 25-35% solution of potassium hydroxide.

- e) Never attempt to open the battery pack for any reason. If the plastic housing of the battery pack breaks open or cracks, immediately discontinue its use and do not recharge it.
- f) Do not store or carry a spare battery pack in a pocket or toolbox or any other place where it may come into contact with metal objects. The battery pack may be short circuited causing damaged to the battery pack, burns or a fire.
- g) The battery pack utilizes nickel-cadmium cells. Cadmium is considered to be a toxic material.

Use an environmentally safe disposal unit at a municipal waste disposal centre to dispose of a damaged or worn out battery, or return it to your dealer.

## **APPLICATION**

### **Intended Use**

The machine is intended for driving in and loosening screws as well as for drilling in wood, metal, ceramic and plastic.

### **Check the delivery parts**

Carefully remove the machine from its packaging and check as the following parts are complete:

- Cordless drill driver
- Rechargeable battery pack
- battery charger
- 14 pcs accessories
- operating instruction
- plastic case

If any parts are missing or damaged, please contact with your dealer.

### **Product Features**

The numbering of the product features refers to the illustration of the machine on the graphics page (Pic.A-B)

1. Keyless chuck
2. Screwdriver bit
3. On/Off switch
4. Torque preselection
5. Rotational direction switch
6. Handle
7. Battery unlocking button
8. Battery pack
9. Charging indicator
10. Battery charger

The accessories illustrated or described are not included as standard delivery.

### **ASSEMBLY**

#### **Battery Charging**



Only use the battery chargers are matched to the nickel-cadmium battery of your power tool.(Pic.B-C)

- 1) There are 2 lamps in the battery charger , red and green. Plug the battery charger into the proper AC voltage source. Green lamp will light
- 2) Insert the battery pack 8 into the charger 10 according with symbol “+” and “-” on battery and charger, both red and green lamp will keep lighting during whole charging process.
- 3) When the battery is fully charged, red lamp will extinguish and green lamp will keep lighting.
- 4) If you leave the battery pack in the charger after the charging cycle is complete, the charger will switch into its “trickle charge (maintenance charge)”mode.
- 5) After charging, unplug the charger from the power source.

**Note:**

- a) The battery charger is for charging SUMEC battery pack. Never use it for other purposes or for other manufacturer’s batteries.
- b) When you charge a new battery pack or a battery pack which has not been used for a long period of time, it may not accept a full charge. This is a normal condition and does not indicate a problem. You can recharge the battery pack fully after discharging it completely and recharging a couple of times.
- c) If you charge a battery pack from a just operated tool or a battery pack which has been left in a location exposed to direct sunlight or heat for a long time, the charging light may flash in red color. If this occurs, wait for a while. Charging will begin after the battery pack cools. The battery pack will cool faster if you remove the battery pack from the high capacity battery charger.
- d) If the charging light flashes alternately in green and red color, a problem exists and charging is not possible. The terminals on the charger or battery pack are clogged with dust or the battery pack is worn out or damaged.

## Fitting and removing the battery pack



### **WARNING**

**Do not continue to press the On/Off switch after the machine has been automatically switched off.** The battery can be damaged.

The battery is supplied partially charged. Completely charge the battery before using your power tool for the first time. The battery can be charged at any time without reducing its service life. Interrupting the charging procedure does not damage the battery.

- a) Always switch off the tool before insertion or removal of the battery pack.
- b) To insert the battery pack 8, align the tongue on the battery pack with the groove in the housing and slip it into place. Always insert it all the way until it locks in place with a little click. If not, it may accidentally fall out of the tool, causing injury to you or someone around you. (Pic.(a))
- c) To remove the battery pack 8, by pressing the battery unlocking button 7 on both sides and pulling the battery out of the power tool toward the rear.
- d) Do not use force when inserting the battery pack. If the pack does not slide in easily, it is not being inserted correctly.

## Changing Tools



### **CAUTION:**

**Always be sure that the tool is switched off and the battery pack is removed before carrying out any work on the tool.**

- 1) Hold the ring and turn the sleeve counter clockwise to open the chuck jaws. Place the bit in the chuck as far as it will go.

- 2) Hold the ring firmly and turn the sleeve clockwise to tighten the chuck.
- 3) To remove the bit, hold the ring and turn the sleeve counter-clockwise.

## **Operation**

### **Starting Operation**

#### **Switching on:**

To start the appliance squeeze on the On/Off switch 3 and then keep it pressed down.

#### **Switching off:**

To stop the appliance, release the On/Off switch 3.

### **Reversing the Rotational Direction**



This tool has a reversing switch to change the direction of rotation. Depress the reversing switch lever from the right 3 side for clockwise rotation or from the left 2 side for counterclockwise rotation.

When the reversing switch lever is in the neutral position, the switch 3 cannot be pulled.

### **Setting the Torque**

The fastening torque can be adjusted in 15+1 steps by turning the adjusting ring so that its graduations are aligned with the pointer on the tool body.

1. Adjusting ring
2. Graduations
3. Pointer

The fastening torque is minimum when the number 1 is aligned with the pointer, and maximum when the  symbol is aligned with the pointer. The clutch will slip to various torque levels when set at the number 1 to 15.

Before actual operation, drive a trial screw into your material or a piece of duplicate material to determine particular application. Level is required for a particular application.

### **Operating Instructions**

- Apply the power tool to the screw only when it is switched off. Rotating tool inserts can slip off.

### **Screw driving operation**

First, slide the action mode change lever to the position of  symbol and select the fastening torque.

Place the point of the driver bit in the screw head and apply pressure to the tool. Start the tool slowly and then increase the speed gradually. Release the switch 3 as soon as the clutch cuts in.



### **CAUTION:**

- Make sure that the driver bit is inserted straight in the screw head, or the screw and/or bit may be damaged.
- When driving wood screws, predrill pilot holes to make driving easier and to prevent splitting of the workpiece. See the chart.
- If the tool is operated continuously until the battery pack has discharged, allow the tool to rest for 15 minutes before proceeding with a fresh battery.

Nominal diameter of wood screw (mm)	Recommended size of pilot hole (mm)
3.1 (1/8")	2.0 - 2.2 (5/64" - 3/32" )
3.5 (9/64")	2.2 - 2.5 (3/32" - 3/32" )
3.8 (5/32")	2.5 - 2.8 (3/32" - 7/64" )
4.5 (11/64")	2.9 - 3.2 (7/64" - 1/8" )
4.8 (3/16")	3.1 - 3.4 (1/8" - 9/64" )



5.1 (13/64)"	3.3 - 3.6 (1/8" - 9/64" )
5.5 (7/32)"	3.7 - 3.9 (9/64" - 5/32" )
5.8 (7/32)"	4.0 - 4.2 (5/32" - 11/64" )
6.1 (15/64)"	4.2 – 4.4 (11/64" - 11/64" )

### Drilling operation

First, slide the fastening torque to the position of  symbol.

### Drilling in wood

When drilling in wood, the best results are obtained with wood drills equipped with a guide screw. The guide screw makes drilling easier by pulling the bit into the workpiece.

### Drilling in metal

To prevent the bit from slipping when starting a hole, make an indentation with a center-punch and hammer at the point to be drilled. Place the point of the bit in the indentation and start drilling. Use a cutting lubricant when drilling metals. The exceptions are iron and brass which should be drilled dry.



### CAUTION:

- a) Pressing excessively on the tool will not speed up the drilling. In fact, this excessive pressure will only serve to damage the tip of your bit, decrease the tool performance and shorten the service life of the tool.
- b) There is a tremendous force exerted on the tool/bit at the time of hole break through. Hold the tool firmly and exert care when the bit begins to break through the workpiece.
- c) A stuck bit can be removed simply by setting the reversing switch to reverse rotation in order to back out. However, the tool may back out abruptly if you do not hold it firmly.
- d) Always secure small workpiece in a vise or similar hold down device.
- e) If the tool is operated continuously until the battery pack has discharged, allow the tool to rest for 15 minutes before proceeding with a fresh battery.

## **Cleaning and Maintenance**



Place the direction of rotation direction switch 6 into the middle position before carrying out any tasks on the device, e.g. changing tools or maintenance, or before transporting or storing the device. Inadvertent operation of the On/Off switch 7 may result in injury.

Always pull the battery charger 12 out of the mains socket and remove the battery pack before you clean or maintain the device.

The cordless Drill/Screwdriver is maintenance-free.

- 1) Always keep the device clean, dry and free of oil or grease.
- 2) Clean the device immediately after you have finished using it
- 3) Do not allow any liquids to enter the device. Use a cloth to clean the housing.
- 4) Never use petrol, solvents or cleaning agents that might attack plastic.
- 5) Store the tools, instruction manual and where necessary the accessories in the original packaging. That way you will always have all the information and parts ready to hand.

### **Maintenance charge**

If you leave the battery pack in the charger to prevent spontaneous discharging after full charge, the charger will switch into its “trickle charge (maintenance charge)” mode and keep the battery pack fresh and fully charged.

### **Tips for maintaining maximum battery life**

- 1) Charge the battery pack before completely discharged. Always stop tool operation and charge the battery pack when you notice less tool power.
- 2) Never recharge a fully charged battery pack. Over charging shortens the battery service life.

- 3) Charge the battery pack with room temperature at 10<sup>0</sup>C-40<sup>0</sup>C (50<sup>0</sup>F-104<sup>0</sup>F) let a hot battery pack cool down before charging it.
- 4) Charge the Nickel-cadmium battery pack when you do not use it for more than six months.

**Do not dispose of electrical appliances with your domestic waste!**



- 1) The packaging comprises exclusively environmentally-friendly material. Dispose of it in your local recycling containers.
- 2) Take the battery to your nearest authorized service center or distributor that has been designated as a battery recycling location.

**Guarantee and Service**

This product is guaranteed for 1 year from the original date of purchase, the guarantee applies to material and production defects. This warranty is not valid without the original dated receipt of purchase.

If the product shows defect as a result of material and production defects during the period of guarantee, providing that the product has been used properly and for the purpose which it has been intended, then faulty products will either be replaced or refunded.

The guarantee does not cover accidental damage or misuse.

This product must be used in accordance with the instructions contained in this manual.

The guarantee will be rendered invalid if the product has been damaged by unauthorised repairs or resold.

Accessories are not covered by the guarantee.

If you have any problems or questions concerning the product, please contact our customer helpline on 0844 856 0793.

# SUMEC

Declaration of Conformity

We,

SUMEC Hardware & Tools Co.,LTD

**1# Xinghuo Road, National level Nanjing High-Tech Zone,**

**Nanjing 210061 P.R. China**

Declare that the product

Cordless Drill

Model No. PG14CD-1

Complies with the essential safety and health requirement of the following directives:

2006/42/EC

2004/108/EC

2006/95/EC

Standards and technical specification referred to:

EN55014-1:2006

EN55014-2:1997/+A1:2001

EN60745-1:2009

EN60745-2-1:2003+A11:07+A1,A12:09

EN60745-2-2:2003+A11:07+A1,A12:09

EN60335-1:2002+A11:2004+A1:2004+A12:2006

EN60335-2-29:2004

EN50366:2003+A1:2006

EN61000-3-2:2006

EN61000-3-3:1995/+A1:2001/+A2:2005

Authorized Signatory

Date: 01.01.2010

Signature:

*Cai Ji Bo*

Name: Cai Jibo

General Manager

SUMEC Hardware & Tools Co..LTD



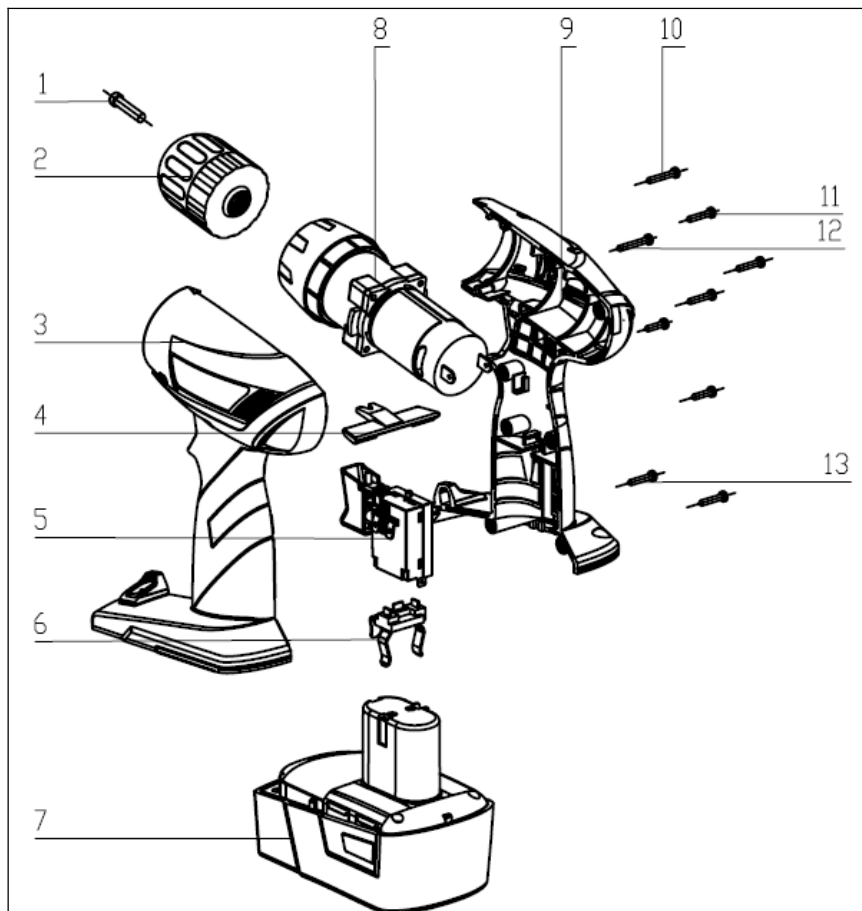

Ref.	Description	Ref.	Description
1	Screw M 5 × 25	8	Gear box and motor
2	Chuck Ø0.8-10mm	9	Right housing
3	Left housing	10	Screw 2.9×19
4	Rotating direction button	11	Screw 2.9×16
5	On/Off switch	12	Screw 2.9×21
6	Spring piece	13	Screw 2.9×12
7	Battery pack		

***Cordless Drill***

***PG14CD-1***

***PowerG***<sup>®</sup>

Sumec Europe GmbH  
Hanns-Martin-Schleyer-Str.18a  
47877 Willich, Germany  
Helpline: 0844 856 0793