



YARD FORCE®

LAWN & GARDEN EQUIPMENT

LB C20

GY1782

GB

40V CORDLESS BLOWER/VACUUM

Original Instructions

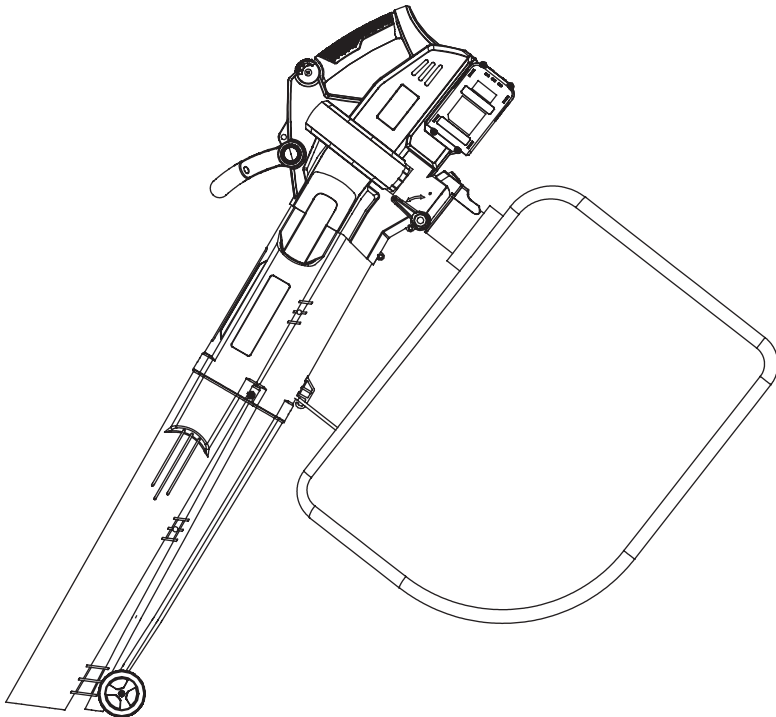

READ & UNDERSTAND INSTRUCTION MANUAL

Save all warnings and instructions for future reference.

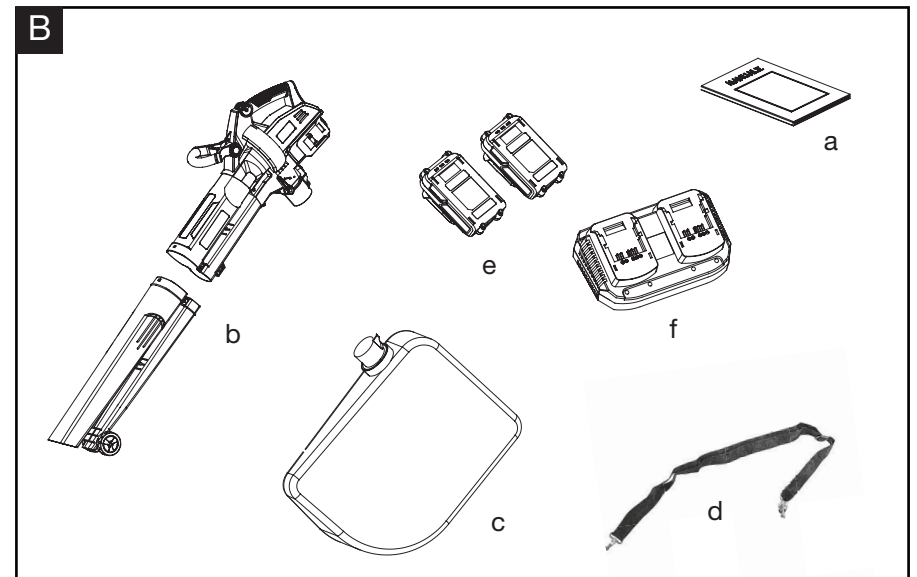
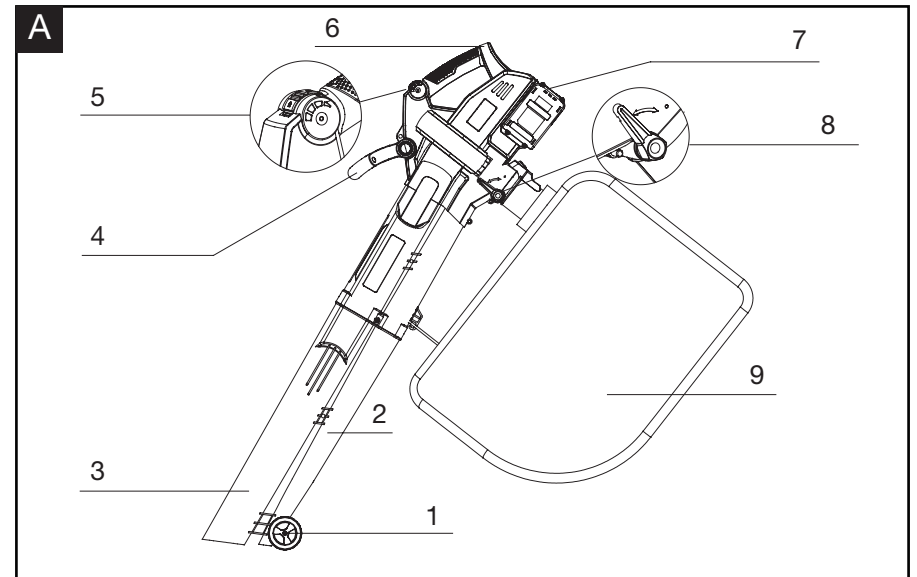

Read this manual carefully prior to assembling and operating the product. It is dangerous to operate this product without being familiar with these instructions. Keep this manual in a safe place and have it ready for future reference.

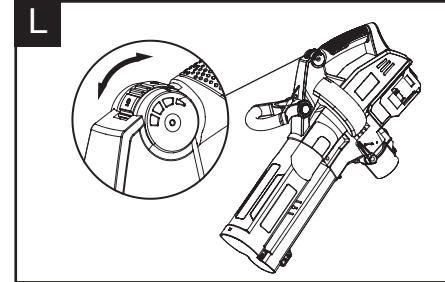
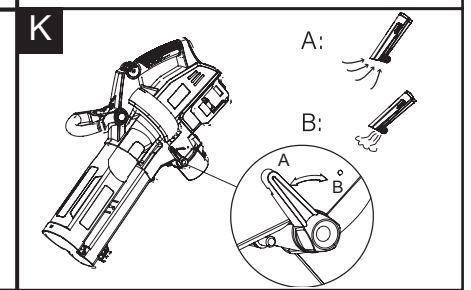
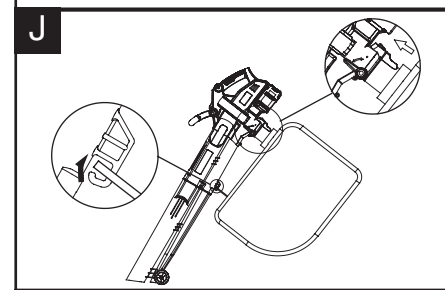
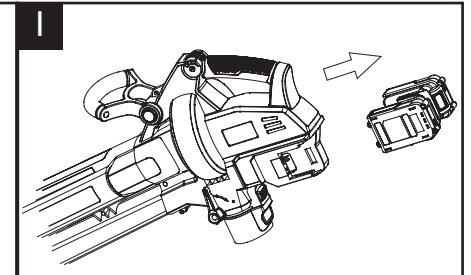
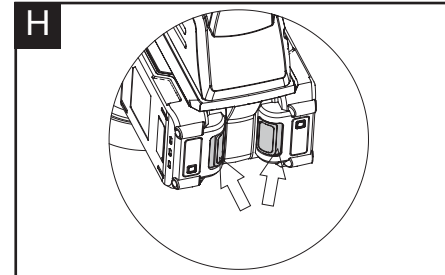
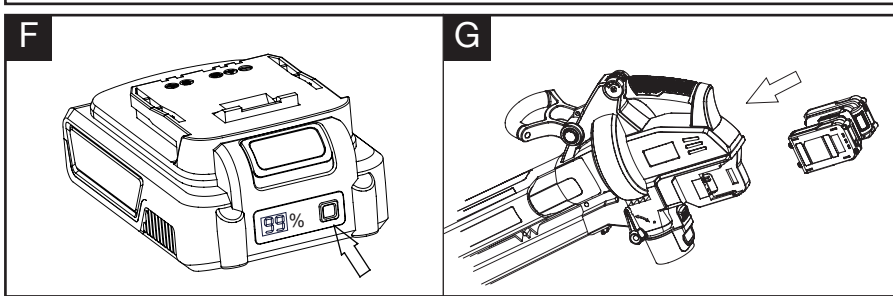
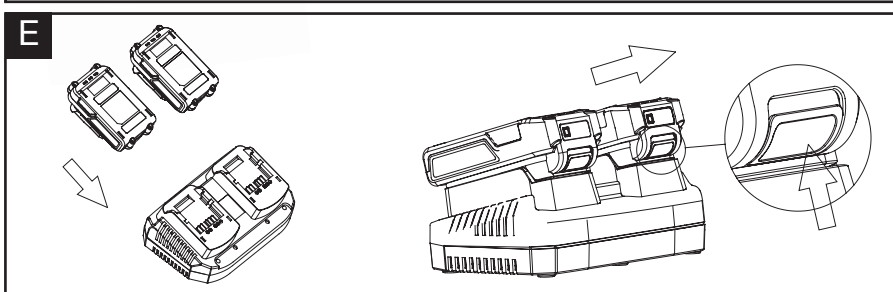
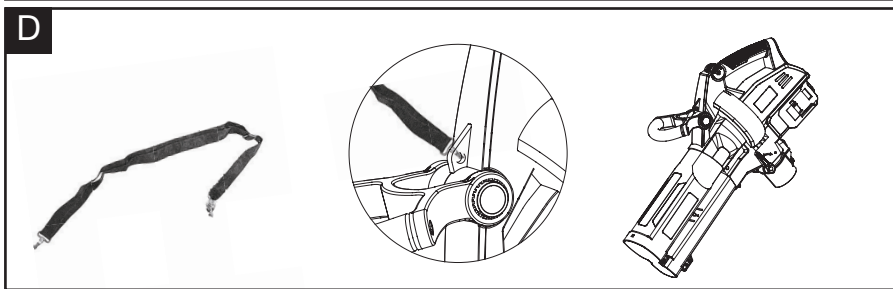
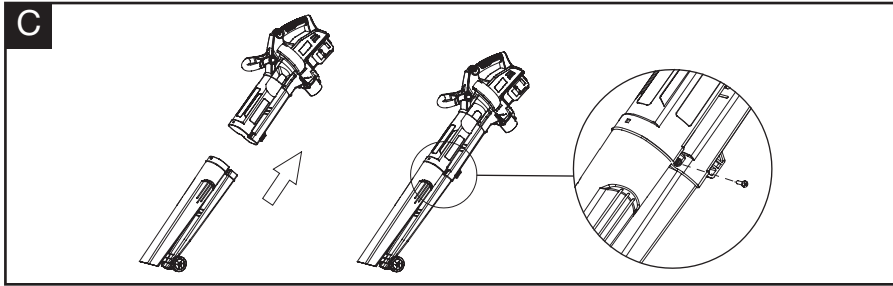

CONTENT

Intended use	07
General safety warnings	07
Product safety warnings	12
Symbols	14
Technical data	18
Description of product	19
Operation	20
Maintenance and storage	22
Troubleshooting	22
CE declaration	23

INTENDED USE

This device is suited solely for the vacuuming and blowing of light and dry materials such as leaves, garden waste, grass, small branches, and small pieces of paper.

The device is intended for private use on private land only.

This product is not intended for commercial use. Generally acknowledged accident prevention regulations and enclosed safety instructions must be observed.

Only perform work described in these instructions for use. Any other use is improper. The manufacturer will not assume responsibility for damage resulting from such use.

GENERAL SAFETY WARNINGS

- To operate this device safely, the user must have read and understood these instructions for use before using the device for the first time.
- Observe all safety instructions! Failure to do so may cause harm to you and others.
- Retain all instructions for use, and safety instructions for future reference.
- If you sell or pass the device on, you must also hand over these operating instructions.
- The device must only be used when it functions properly. If the device or part of the device is defective, have it repaired by a specialist.
- Never use the device in a room where there is a danger of explosion or in the vicinity of flammable liquids or gases.
- Always ensure that a device which has been switched off cannot be restarted unintentionally.
- Do not use devices with an on/off switch that does not function correctly.
- Keep children away from the device! Keep the device out of the way of children and other unauthorised persons.
- Do not overload the device. Do not use the device for purposes for which it is not intended.

GENERAL SAFETY WARNINGS

- Make sure to always wear the required personal protective equipment.
- Exercise caution and only work when in good condition:
 - if you are tired or ill.
 - if you have ingested alcohol, medication or illegal drugs, do not use the device, as you are not in a condition to use it safely.
- This product is not intended to be used by persons (including children) who are limited in their physical, sensory or mental capacities or who lack experience and/or knowledge of the product, unless they are supervised or have been instructed on how to use the product by a person responsible for their safety.
- Ensure that children are not able to play with the device.
- Always comply with all applicable domestic and international safety, health, and working regulations.

Risks caused by vibrations

CAUTION! Risk of injury due to vibrations!

Vibrations may, in particular for persons with circulation problems, cause damage to blood vessels and/or nerves. If you notice any of the following symptoms, stop working immediately and consult a doctor: Numbness of body parts, loss of sense of feeling, itching, pins and needles, pain, changes in skin colour.

The vibration values specified in the technical data represent the main uses of the device. The actual existing vibrations during use may deviate from these as a result of the following factors:

- Incorrect use of the product;
- Unsuitable tools inserted;

GENERAL SAFETY WARNINGS

- Unsuitable material;
- Insufficient maintenance.

You can reduce the risks considerably by following the tips below:

- Maintain the device in accordance with the instructions in the operating instructions.
- Avoid working at low temperatures.
- When it is cold, make sure your body and your hands in particular, are kept warm.
- Take regular breaks and move your hands at the same time to promote circulation.

Electrical safety

- The device may only be connected to a socket that is correctly installed and grounded.
- The fuse must be a residual current circuitbreaker with a measured residual current of no more than 30 mA.
- Make sure that the power supply corresponds with the connection specifications of the device before it is connected.
- The tool may only be used within the specified limitations for voltage and power (see type plate).
- Do not touch the mains plug with wet hands! Always pull out the mains plug at the socket and not by the cable.
- Do not bend, crush, pull or drive over the power cable, protect from sharp edges, oil and heat.
- Do not lift the device using the cable or use the cable for purposes other than intended.
- Check the plug and cable before each use.
- If the power cable is damaged immediately disconnect the plug. Never use the device if the power cable is

GENERAL SAFETY WARNINGS

damaged.

- If the device is not in use, make sure the plug is pulled out.
- Make sure that the device is switched off before plugging in the mains cable.
- Make sure that the device is switched off before unplugging it.
- Disconnect the power supply before transporting the device.

Handling rechargeable devices

- Danger of fire! Only use batteries approved by the manufacturer. Only use chargers approved by the manufacturer. Keep battery away from metal objects that could cause short circuiting when not in use. There is a risk of injuries and fires.
- Prior to connecting the charger, verify that the power supply connection corresponds with the connecting data of the device.
- The fuse must be a residual current circuitbreaker with a measured residual current of no more than 30 mA.
- Only charge the battery in closed rooms.
- Ensure that the device is switched off before installing the battery.
- Never switch on the device during the charging process.
- Fluid can escape from the battery when used incorrectly. Battery fluid may result in skin irritations and burns. Avoid contact! In the event of accidental contact, rinse thoroughly with water. Immediately seek the aid of a physician in the event of eye contact.

GENERAL SAFETY WARNINGS

Maintenance

- Before conducting any maintenance on the device, make sure the battery has been removed.
- Before conducting any maintenance on the device, disconnect the mains plug.
- Only those maintenance and fault elimination tasks described here may be carried out. Any other tasks must be completed by a specialist.
- Only use original replacement parts. Only these replacement parts are designed and suitable for the device. Other replacement parts will not only lead to an invalidation of the warranty, they may also endanger you and your environment.

SAVE THESE INSTRUCTIONS!

PRODUCT SAFETY WARNINGS

- When working with the device, always maintain a safe distance and natural body position.
- Always hold the device firmly in both hands.
- Before starting to work, check the working area for animals and objects. Remove all objects that may be slung away or become jammed in the cutting tool.
- Do not attempt to remove materials to be vacuumed or to hold material already vacuumed when the motor is running. Only remove any jammed material to be vacuumed when the device is switched off.
- No other persons or animals may be present within an area of 15 m around the vacuuming area, as they may otherwise be injured by objects being slung away.
- Only work in well lit conditions where visibility is good.
- Do not work above head height! Do not lean forward or back!
- The operator must wear tightly fitting clothing. Avoid wearing loose clothing. Wear sturdy shoes and long trousers.
- Take care when walking backwards. Danger of stumbling!
- Never work in the rain.
- Vacuuming or blowing of heavy materials such as metal, stones, branches, fir cones or broken glass is expressly forbidden.
- Keep all parts of your body away from the vacuum opening.
- When working with the device, ensure that there is sufficient lighting.
- Always wear the required personal protective equipment.

PRODUCT SAFETY WARNINGS

- Be careful of the dust you have raised and flying objects. Especially dangerous is the rebound effect on walls.
- Do not direct the device at people or animals when vacuuming or blowing.
- Before starting to blow, loosen foreign bodies with a rake or broom.
- The machine may only be operated during sensible hours – not too early in the morning or too late in the evening, as it may disturb other people.
- The times listed by the local authorities must be adhered to.
- The whole blower nozzle piece must be used so that the airstream can work close to the ground.
- Be aware of children and pets, close the windows and blow the foreign bodies safely away.
- Remember that moving parts may also be located behind ventilation and venting slots.
- Symbols which are on your device may not be removed or covered. Notes on the device which are no longer legible must be replaced immediately.

SYMBOLS

Safety symbols

The purpose of safety symbols is to attract your attention to possible dangers. The safety symbols and the explanations with them require your careful attention and full understanding. The symbol warnings do not, by themselves, eliminate any danger. The instructions and warnings they give are no substitutes for proper accident prevention measures.

WARNING: Be sure to read and understand all safety instructions in this operators manual, including all safety alert symbols such as “**DANGER**,” “**WARNING**,” and “**CAUTION**” before using this tool. Failure to follow all instructions listed below may result in electric shock, fire and/or serious personal injury.

SAFETY ALERT SYMBOL: Indicates **DANGER**, **WARNING**, or **CAUTION**. May be used in conjunction with other symbols or pictographs.

Symbol meaning

This page depicts and describes safety symbols that may appear on this product. Read, understand and follow all instructions on the machine before attempting to assemble and operate.

SYMBOLS

 Read the operating instructions before use!

 Be careful when handling the device! Observe all safety instructions in the instructions manual!

 Don't expose to rain.

 Risk of injury due to flying parts!





 Risk of injury caused by rotating machine parts!

 Risk of injury caused by rotating machine parts!

 When working with the device, wear eye and ear protection.

 Wear sturdy shoes when working with the device.

 Wear protective gloves when working with the device.

 Wear tightly fitting clothing when working with the device.

 Guaranteed sound power level value is 98 dB.

SYMBOLS

Warning symbols on the battery pack



To reduce the risk of injury, user must read the instruction manual carefully.



Do not throw into water.



Do not throw on to fire.



Do not subject the battery to strong sunlight over long periods of time. Do not leave on a heater (max.45°C).



Li-Ion

Batteries contain Li-ion. Do not dispose of waste batteries in domestic waste. Contact local authority to find out how to dispose of batteries.



WEEE symbol. Waste electrical products should not be disposed of with household waste. Please recycle where facilities exist. Check with your Local Authority or local store for recycling advice.

SYMBOLS

Warning symbols on the charger



To reduce the risk of injury, user must read the instruction manual carefully.



The charger is for indoor use only.



Double insulation



WEEE symbol. Waste electrical products should not be disposed of with household waste. Please recycle where facilities exist. Check with your Local Authority or local store for recycling advice.





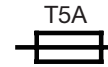



The product complies with the applicable European directives and an evaluation method of conformity for these directives was done.



Protective 5 A limited

TECHNICAL DATA

Model		LB C20
Mains voltage		40 V  , 2.0AH
max. blow speed		200 km/h
Bag content		45 l
Mulch ratio		8:1
Weight		3.15 kg
Sound pressure level: LpA*		75.8 dB(A) K=3 dB(A)
Sound power level: LwA**		95.3 dB(A) K=3 dB(A)
Vibration front handle		4 m/s ² K=1.5 m/s ²
Battery pack Model		B0P-SP07-20-C
Battery capacity		20 V  , 2.0 Ah
Battery charger Model		VDE: B0Q-SP07-2040ZA BS: B0Q-SP07-2040ZB
Input		220-240V AC, 50/60Hz 110 W
Output		21 V  , 4 A
Protection class		II

*) The specified values are emission values and do not necessarily represent safe workplace values. Although there is a correlation between emission and immission levels, this cannot be used to infer whether additional safety measures are necessary or not.

Factors which affect the current immission levels at the workplace, include the type of room, other sources of noise, e. g. the number of machines operating and other processes taking place in the vicinity. Permitted workplace values can differ from country to country. This information is designed to help the user to better assess the dangers and risks. Determination of noise emission values in accordance with EN 60745-1.

**) The specified vibration emission value was measured in accordance with a normed test procedure and can be used in order to compare one tool with another. The specified vibration emission value can also be used for an introductory evaluation of the exposure. The vibration emission value may fluctuate from the specified value during actual use of the power tool. These fluctuations will depend on the way in which the power tool is used.

Try to keep vibrations to a minimum. One method of reducing the vibration load is, for example, limiting the length of time you work with the tool. All parts of the operating cycle must be taken into account for this purpose (for example, also including times in which the power tool is switched off and times in which it is switched on, but is running without load). Determination of vibration emission values in accordance with EN 60745-1.

DESCRIPTION OF PRODUCT

Parts description (Fig. A)

1. Rollers
2. Blower nozzle
3. Suction tube
4. Grip for front hand
5. On/Off switch
6. Grip for rear hand
7. Battery pack
8. Adjustment lever (blowing, vacuuming)
9. Collection bag

Delivery contents (Fig. B)

Carefully unpack the appliance and check that it is complete. Dispose of the packaging material correctly.

- a. Original Instructions
- b. Cordless Blower/Vacuum
- c. Collection bag
- d. Shoulder strap
- e. Battery pack x2
- f. Charger



WARNING: If any parts are damaged or missing, do not operate this tool until these parts are replaced. Failure to heed this warning could result in serious personal injury.



NOTE: Always recycle the packaging in accordance with local recycling guidelines.

ASSEMBLY

Install the suction pipe and shoulder strap

1. Insert the suction pipe into the device and screw into place. (Fig. C)
2. Hook the shoulder strap onto the device as shown. (Fig. D)

OPERATION

Charging the battery pack

NOTE: Remove the battery pack from the charger after it has been fully charged.

NOTE: Battery should be fully charged before first use.

NOTE: Make sure the mains voltage is the same as rating label which is located on the charger.

1. Connect the charger to a power supply. Red LED will light up.
2. To insert the battery pack into the charger, align the raised ribs of the battery pack with the grooves of the charger then push it in. (Fig. E)
3. The red LED light of the charger will light up followed by green flashing light during the charging.
4. After charging is complete, the charger light will turn to a solid green light.
5. Once the battery is fully charged, depress the battery release button and then remove the battery pack.

Power indicator (See Fig. F)

This Li-Ion battery pack is equipped with a power indicator which is used to show the battery packs remaining charge. Press the power indicator button to check battery charge as picture shown. The indicator will stay lit for approximately 4 seconds.

To obtain the best life from the battery

1. Never allow the battery to completely discharge before recharging. The battery pack should be placed on the charger whenever the battery pack is noticeably running down or the tool no longer performs a task it previously performed.
2. Avoid conducting short charges. Make sure that the battery is fully charged each time by allowing the charger to complete its full charging cycle.
3. Avoid allowing loose items like screws or nails etc. to be stored with battery packs as these or similar items can short battery packs and cause a fire or explosion.
4. Always unplug the charger when not in use and store in a dry and secure place.
5. Avoid charging or storing your battery in temperatures below 5°C and above 45°C.
6. After use, allow the battery pack to cool down for approximately 30 minutes before attempting to recharge.

OPERATION

To insert the battery pack (Fig. G)

1. Align the groove on the battery pack with the corresponding ribs in the receptacle of the device.
2. Insert the battery pack with moderate force until it locks in to place.

WARNING: Only use Yard Force 20V original battery pack!

To remove the battery pack from the tool

1. Press the battery pack release button. (Fig. H)
2. Remove the battery pack from the tool. (Fig. I)

Check before starting!

DANGER! Risk of injury! The device must only be put into operation if no faults are found. If any part of the device is defective, it must be replaced before the next use.

Check the safety equipment and the safe condition of the device.

- Check all parts to make sure they fit tightly.
- Check whether there are visible defects: broken parts, cracks, etc.

Attaching the collection bag (Fig. J)

1. Hook the front of the collection bag to the device as shown.
2. Insert the nozzle of the collection bag as far as it will go into the device
 - Ensure that the bag has slotted into place securely.

Selecting the operating mode

- Set adjustment lever to vacuum [A] or blowr [B]. (Fig. K)
- When using as a leaf vacuum: insert the collection bag as shown into the device and ensure that it clicks into place.
- When using as a leaf blower: press the unlocking button and remove the collection bag.

Switching on and off (Fig. L)

- Set the On/Off switch to position [1–5] to switch the appliance on.
- Set the On/Off switch to position [0] to switch the appliance off.

Note: Work with leaf blowers/vacuums may not be performed during normal quiet hours.

Setting the blower or vacuum speed

- Set the On/Off switch to the required blowing or vacuuming speed.

MAINTENANCE AND STORAGE

DANGER! Risk of injury!

Switch off the product and disconnect the mains plug before all cleaning and maintenance work. Wait until all moving parts are completely stopped.

Cleaning the device

- Brush off coarse dirt.
- Wipe down the device with a slightly damp cloth.
- Clean the collection bag regularly

Removing the collection bag

– Press the unlocking button and remove the collection bag.

Storage, transport

Storage

DANGER! Risk of injury! Make sure that unauthorized persons do not have access to the device!

- Store the device in a dry place.
- Empty the collection bag before storing.

Transport

- Secure the device against slipping.
- If possible, use the original packaging for dispatching.

TROUBLESHOOTING

Fault/malfunction	Cause	Remedial measure
Motor not running	Battery pack discharged?	Fully charge the battery pack
	Battery pack is not connected correctly	Install the battery pack once again
Blower/Vacuum not powerful enough	Collection bag full?	Empty Collection bag
	Suction speed too low?	Adjust the speed setting

CE DECLARATION

To the provisions of Council Directives

We
SUMEC UK

Unit A&B Escrick Business Park Escrick, York YO19 6FD/ United Kingdom

Declare that the product:
Description: 40V Cordless Blower/Vacuum
Model No. LB C20 / GY1782
Function: vacuuming and blowing leaves

Complies with the essential health and safety requirements of the following directives:

Machinery Directive 2006/42/EC
Electromagnetic Compatibility Directive 2014/30/EU
EC Directive 2011/65/EU and its amendment Directive (EU) 2015/863 (RoHS)
Noise Emission in the Environment by Equipment for Use Outdoors Directive 2000/14/EC amended by 2005/88/EC
Measured Sound Power Level: 95 dB (A)
Declared Guaranteed Sound Power Level: 98 dB (A)

Standards and technical specification referred to:

EN 60335-1: 2012+ A11: 2014
EN 50636-2-100: 2014
EN 62233: 2008
EN 55014-1: 2017
EN 55014-2: 2015
EN 61000-3-2: 2014
EN 61000-3-3: 2013
EN 50581: 2012

Authorized Signatory
Date: 18.10.2019

Signature: 
Place: York
Name: Mariana Hall
General Manager

SUMEC UK Co.,Ltd.
Unit A&B Escrick Business Park
Escrick, York YO19 6FD/ United Kingdom



CE DECLARATION

To the provisions of Council Directives

We
MEROTEC GmbH,
Otto-Brenner-Straße 8,
47877 Willich/ Deutschland

Declare that the product:
Description: 40V Cordless Blower/Vacuum
Model No. LB C20 / GY1782
Function: vacuuming and blowing leaves

Complies with the essential health and safety requirements of the following directives:

Machinery Directive 2006/42/EC
Electromagnetic Compatibility Directive 2014/30/EU
EC Directive 2011/65/EU and its amendment Directive (EU) 2015/863 (RoHS)
Noise Emission in the Environment by Equipment for Use Outdoors Directive 2000/14/EC amended by 2005/88/EC
Measured Sound Power Level: 95 dB (A)
Declared Guaranteed Sound Power Level: 98 dB (A)

Standards and technical specification referred to:

EN 60335-1: 2012+ A11: 2014
EN 50636-2-100: 2014
EN 62233: 2008
EN 55014-1: 2017
EN 55014-2: 2015
EN 61000-3-2: 2014
EN 61000-3-3: 2013
EN 50581: 2012

Authorized Signatory
Date: 18.10.2019

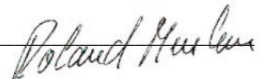
Signature: 
Place: Willich
Name: Roland Menken
General Manager

MEROTEC GmbH,
Otto-Brenner-Straße 8,
47877 Willich/ Deutschland



CE DECLARATION

To the provisions of Council Directives

We
SUMEC France Sarl
59 bis Rue du Mûrier
37540 Saint Cyr Sur Loire, France

Declare that the product:
Description: 40V Cordless Blower/Vacuum
Model No. LB C20 / GY1782
Function: vacuuming and blowing leaves

Complies with the essential health and safety requirements of the following directives:

Machinery Directive 2006/42/EC
Electromagnetic Compatibility Directive 2014/30/EU
EC Directive 2011/65/EU and its amendment Directive (EU) 2015/863 (RoHS)
Noise Emission in the Environment by Equipment for Use Outdoors Directive 2000/14/EC amended by 2005/88/EC
Measured Sound Power Level: 95 dB (A)
Declared Guaranteed Sound Power Level: 98 dB (A)

Standards and technical specification referred to:

EN 60335-1: 2012+ A11: 2014
EN 50636-2-100: 2014
EN 62233: 2008
EN 55014-1: 2017
EN 55014-2: 2015
EN 61000-3-2: 2014
EN 61000-3-3: 2013
EN 50581: 2012

Authorized Signatory
Date: 18.10.2019

Signature: 
Place: Saint Cyr Sur Loire
Name: Rodolphe Dubois
General Manager

SUMEC France Sarl
59 bis Rue du Mûrier
37540 Saint Cyr Sur Loire, France

