

Original User's Instructions

# 450W Electric Grass Trimmer

SKU: 90598

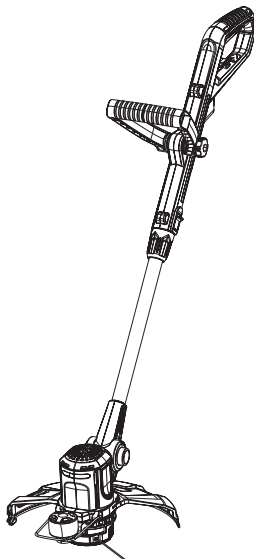

## WHAT'S IN THE BOX

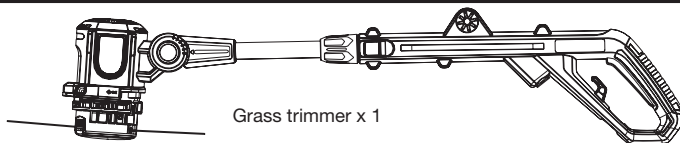

Spare spool  
x 2



Support wheel  
x 1



Plant protector  
x 1

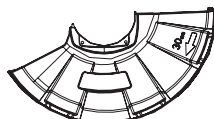

Guard x 1

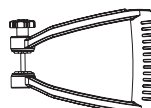

Front handle  
x 1

If you do not have all these items, please contact:

[www.coreservice.co.uk](http://www.coreservice.co.uk)

Hotline: +44 01904 947568

Email [www.coreservice.co.uk](mailto:www.coreservice.co.uk)

**PLEASE KEEP THESE INSTRUCTIONS FOR FURTHER REFERENCE**

## TOOLS REQUIRED

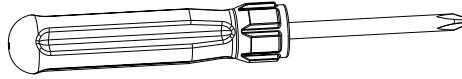

## SPECIFICATION

Technical Data	
Model	DT4302
Input voltage rating	230-240V~/50Hz
Input power	450W
No load speed	10000min
Dual line	Ø1.4 mm, length 2X5m
Cutting width	300mm
Protection class	II / □
Protection category	IP20
Angle adjustment	0°~90°
Weight	2.5kg
Measured sound pressure level	$L_{pA,eq}$ : 80.4dB(A) Uncertain $K_{pA}$ =3.0dB(A)
Measured sound power level	$L_{wA,eq}$ : 95.8dB(A) $K=1$ dB(A)
Guaranteed sound power level	$L_{wA,d}$ : 96dB(A)
Vibration at the main handle Vibration at the auxiliary handle	$a_{h1}$ : max. 2.5 m/s <sup>2</sup> , $K=1.5$ m/s <sup>2</sup>
Cord	PVC 2x0.75mm <sup>2</sup> , 10m, BS plug

The sound values have been determined according to noise test code given in EN 786, using the basic standards EN ISO 11201 and EN ISO 3744.

The sound intensity level for the operator may exceed 80 dB(A) and ear protection measures are necessary.

The declared vibration value has been measured in accordance with a standard test method (according to EN 786) and may be used for comparing one product with another. The declared vibration value may also be used in a preliminary assessment of exposure.



## WARNING!

Depending on the actual use of the product the vibration values can differ from the declared total! Adopt proper measures to protect yourself against vibration exposures! Take the whole work process including times the product is running under no load or switched off into consideration!

Proper measures include among others regular maintenance and care of the product and cutting attachments, keeping hands warm, periodical breaks and proper planning of work processes!

## INTENDED USE

The product is intended for cutting weed, grass or similar soft vegetation in areas that are hard to reach, e.g. under bushes, on slopes and edges. It may not be used to work on unusual thick, dry or wet grass, e.g. pasture grass, or to shred leaves.

For safety reasons it is essential to read the entire instruction manual before first operation and to observe all the instructions therein.

This product is intended for private domestic use only, not for any commercial trade use. It must not be used for any purposes other than those described.

## EXPLANATIONS AND SYMBOLS, CAUTIONS AND WARNINGS



Symbol warning of a warning



Read and refer to these operating instructions



Wear hearing protection.



Wear eye protection.



Wear respiratory protection.



Wear safety shoes



Do not expose the product to rain or wet conditions (moisture).



Objects thrown by the product could hit the user or other bystanders. Always ensure that other people and pets remain at a safe distance from the product when it is in operation. In general, children must not come near the area where the product is.



Disconnect from the mains plug if the cord is damaged or entangled. **DO NOT TOUCH THE CORD BEFORE DISCONNECTING THE SUPPLY.**

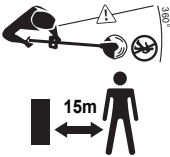

**Keep other people out of working area during operation. A distance of at least 15 m must be observed.**



Switch the product off and disconnect it from the power supply before assembly, cleaning, adjustments, maintenance, storage and transportation.



This product is of protection class II.



Guarantee sound power level



The product complies with the applicable European directives and an evaluation method of conformity for these directives was done.



WEEE symbol. Waste electrical products should not be disposed of with household waste. Please recycle where facilities exist. Check with your Local Authority or local store for recycling advice.



A product placed on the United Kingdom market meets the UKCA Marking requirements

## HEALTH AND SAFETY

This product is not intended for use by persons (including children) with reduced physical, sensory or mental capabilities, or lack of experience and knowledge, unless they have been given supervision or instruction concerning use of the product by a person responsible for their safety.

Children should be supervised to ensure that they do not play with the product.



**WARNING! Read all safety warnings and all instructions. Failure to follow the warnings and instructions may result in electric shock, fire and/or serious injury. Save all warnings and instructions for future reference. The term "power tool" in the warnings refers to your mains-operated (corded) power tool or battery-operated (cordless) power tool.**

### Work area safety

1. Keep work area clean and well lit. Cluttered or dark areas invite accidents.
2. Do not operate power tools in explosive atmospheres, such as in the presence of flammable liquids, gases or dust. Power tools create sparks which may ignite the dust or fumes.
3. Keep children and bystanders away while operating a power tool. Distractions can cause you to lose control.

### Electrical safety

1. Power tool plugs must match the outlet. Never modify the plug in any way. Do not use any adapter plugs with earthed

- (grounded) power tools. Unmodified plugs and matching outlets will reduce risk of electric shock.
2. Avoid body contact with earthed or grounded surfaces, such as pipes, radiators, ranges and refrigerators. There is an increased risk of electric shock if your body is earthed or grounded.
  3. Do not expose power tools to rain or wet conditions. Water entering a power tool will increase the risk of electric shock.
  4. Do not abuse the cord. Never use the cord for carrying, pulling or unplugging the power tool. Keep cord away from heat, oil, sharp edges or moving parts. Damaged or entangled cords increase the risk of electric shock.
  5. When operating a power tool outdoors, use an extension cord suitable for outdoor use. Use of a cord suitable for outdoor use reduces the risk of electric shock.
  6. If operating a power tool in a damp location is unavoidable, use a residual current device (RCD) protected supply. Use of an RCD reduces the risk of electric shock.

## **Personal safety**

1. Stay alert, watch what you are doing and use common sense when operating a power tool. Do not use a power tool while you are tired or under the influence of drugs, alcohol or medication. A moment of inattention while operating power tools may result in serious personal injury.
2. Use personal protective equipment. Always wear eye protection. Protective equipment such as dust mask, non-skid safety shoes, hard hat, or hearing protection used for appropriate conditions will reduce personal injuries.
3. Prevent unintentional starting. Ensure the switch is in

the off-position before connecting to power source and/or battery pack, picking up or carrying the tool. Carrying power tools with your finger on the switch or energising power tools that have the switch on invites accidents.

4. Remove any adjusting key or wrench before turning the power tool on. A wrench or a key left attached to a rotating part of the power tool may result in personal injury.
5. Do not overreach. Keep proper footing and balance at all times. This enables better control of the power tool in unexpected situations.
6. Dress properly. Do not wear loose clothing or jewellery. Keep your hair, clothing and gloves away from moving parts. Loose clothes, jewellery or long hair can be caught in moving parts.
7. If devices are provided for the connection of dust extraction and collection facilities, ensure these are connected and properly used. Use of dust collection can reduce dust-related hazards.

### **Power tool use and care**

1. Do not force the power tool. Use the correct power tool for your application. The correct power tool will do the job better and safer at the rate for which it was designed.
2. Do not use the power tool if the switch does not turn it on and off. Any power tool that cannot be controlled with the switch is dangerous and must be repaired.
3. Disconnect the plug from the power source and/or the battery pack from the power tool before making any adjustments, changing accessories, or storing power tools. Such preventive safety measures reduce the risk of starting the power tool accidentally.

4. Store idle power tools out of the reach of children and do not allow persons unfamiliar with the power tool or these instructions to operate the power tool. Power tools are dangerous in the hands of untrained users.
5. Maintain power tools. Check for misalignment or binding of moving parts, breakage of parts and any other condition that may affect the power tool's operation. If damaged, have the power tool repaired before use. Many accidents are caused by poorly maintained power tools.
6. Keep cutting tools sharp and clean. Properly maintained cutting tools with sharp cutting edges are less likely to bind and are easier to control.
7. Use the power tool, accessories and tool bits etc. in accordance with these instructions, taking into account the working conditions and the work to be performed. Use of the power tool for operations different from those intended could result in a hazardous situation.

## **Service**

1. Have your power tools serviced by a qualified repair person using only identical replacement parts. This will ensure that safety of the power tool is maintained.

## **ELECTRICALLY POWERED GRASS TRIMMER SAFETY WARNINGS**

### **IMPORTANT**

### **READ CAREFULLY BEFORE USE**

### **KEEP FOR YOUR REFERENCE**





**WARNING!** When using the product the safety rules must be followed. For your own safety and that of bystanders please read these instructions before operating the product. Please keep the instructions safe for later use.

## **Training**

1. Read the instructions carefully. Be familiar with the controls and the proper use of the product.
2. Never allow people unfamiliar with these instructions or children to use the product. Local regulations can restrict the age of the operator.
3. Keep in mind that the operator or user is responsible for accidents or hazards occurring to other people or their property.

## **Preparation**

1. Never operate the product while people, especially children, or pets are nearby.
2. Wear eye protection and stout shoes at all times while operating the product

## **Operation**

1. Use the product only in daylight or good artificial light.
2. Never operate the product with damaged guards or shields or without guards or shields in place.
3. Keep hands and feet away from the cutting attachment at all times and especially when switching on the motor.
4. Before use check the controls and proper use of the product.

5. Before using the product and after any impact, check for signs of wear or damage and repair as necessary.
6. Always disconnect the product from the power supply (i.e. remove the plug from the power supply or the battery pack)
  - whenever leaving the product unattended;
  - before clearing a blockage;
  - before checking, cleaning or working on the product
  - after striking a foreign object;
  - whenever the product starts vibrating abnormally.
7. Take care against injury to feet and hands from the cutting attachment.
8. Always ensure that the air vents are kept clear of debris.
9. Take care against injury from any device fitted for trimming the filament line length, if applicable. After extending new cutter line always return the product to its normal operating position before switching on.
10. Never fit metal cutting elements.
11. Never replace non-metallic cutting means with metallic cutting means.
12. Never use replacement parts or accessories not provided or recommended by the manufacturer.
13. The product should be supplied via a residual current device (RCD) with a tripping current of not more than 30 mA.
14. Avoid using the product in bad weather conditions especially when there is a risk of lightning.
15. Position the cord so that it will not be caught by the cutting

attachment during operation.

16. Disconnect from the power supply when the cord becomes damaged or tangled.
17. If the cord becomes damaged during use, disconnect the cord from the supply immediately. **DO NOT TOUCH THE CORD BEFORE DISCONNECTING THE SUPPLY.**
18. Do not use the product if the cord is damaged or worn.
19. Warning! The cutting elements continue to rotate after the product is switched off.
20. Keep the extension cord away from cutting elements.
21. Only use an extension cord not lighter than:
  - if rubber insulated, ordinary tough rubber sheathed flexible cord (code designation 60245 IEC 53);
  - if polyvinyl chloride insulated, ordinary polyvinyl chloride sheathed flexible cord (code designation 60227 IEC 53).
22. Do not expose the product to rain.

## **MAINTENANCE AND STORAGE**

1. Disconnect the product from the power supply (i.e. remove the plug from the power supply or the battery pack) and check for damage after use.
2. Disconnect the product from the power supply (i.e. remove the plug from the power supply or the battery pack) before carrying out maintenance or cleaning work.
3. Use only the manufacturer's recommended replacement parts and accessories.
4. Inspect and maintain the product regularly. Have the product repaired only by an authorised service centre or similar qualified specialist.

5. When not in use, store the product out of the reach of children.

## **VIBRATION AND NOISE REDUCTION**

To reduce the impact of noise and vibration emission, limit the time of operation, use low-vibration and low-noise operating modes as well as wear personal protective equipment.

Take the following points into account to minimize the vibration and noise exposure risks:

1. Only use the product as intended by its design and these instructions.
2. Ensure that the product is in good condition and well maintained.
3. Use correct cutting device for the product and ensure they in good condition.
4. Keep tight grip on the handles/gripping surface.
5. Maintain this product in accordance with these instructions and keep it well lubricated (where appropriate).
6. Plan your work schedule to spread any high vibration tool use across a longer period of time.

## **EMERGENCY**

Familiarise yourself with the use of this product by means of this instruction manual. Memorise the safety directions and follow them to the letter. This will help to prevent risks and hazards.

1. Always be alert when using this product, so that you can recognise and handle risks early. Fast intervention can prevent serious injury and damage to property.

2. Switch off and disconnect from the power supply if there is any malfunction. Have the product checked by a qualified specialist and repaired, if necessary, before you put it into operation again.

## **RESIDUAL RISKS**

Even if you are operating this product in accordance with all the safety requirements, potential risks of injury and damage remain. The following dangers can arise in connection with the structure and design of this product:

1. Health defects resulting from vibration emission if the product is being used over long periods of time or not adequately managed and properly maintained.
2. Injuries and damage to property due to broken application tools or the sudden impact of hidden objects during use.
3. Danger of injury and property damage caused by flying objects.



**WARNING!** This product produces an electromagnetic field during operation! This field may under some circumstances interfere with active or passive medical implants! To reduce the risk of serious or fatal injury, we recommend persons with medical implants to consult their doctor and the medical implant manufacturer before operating this product!

## ASSEMBLY AND USE

### 1. Assembly

#### a. Safety guard and support wheel assembly

- 1) Remove four mounting screws from motor housing.



**Note:** They are pre-mounted on the motor housing by factory to help end-user find them quickly. And send a message to end-user, where these four screws should be used for.

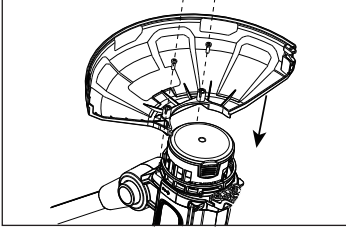

- 2) Fit the safety guard onto the motor housing.
- 3) Fix the safety guard in place by using these 2 screws.
- 4) Fix the edging wheel in place by using 2 screws.

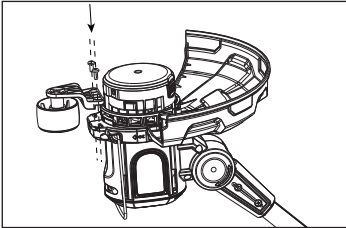

#### b. Front handle assembly

- 1) Loosen the knob and remove it together with the bolt from the auxiliary handle.
- 2) Align the auxiliary handle to the support and place it onto the grass trimmer.
- 3) Insert the bolt from the right through the opening. Ensure that the bolt head sits properly in the recessed shape in the support then tighten the knob.

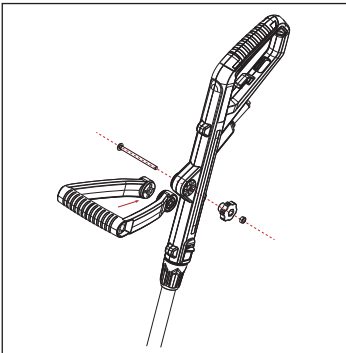

#### c. Plant protector assembly

Assemble the plant protector into the slots at front .

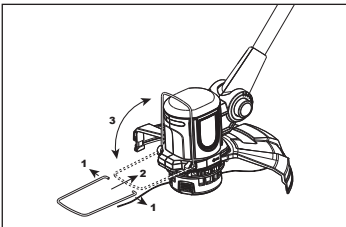

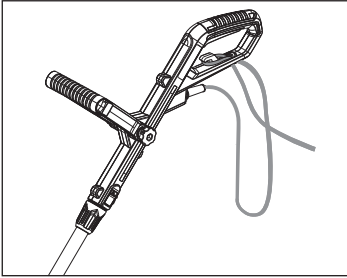

#### **d. Cord strain relief**

- 1) Make sure the on/off switch is in its off position.
- 2) Double the cord, about 3cm from the end. Lead the loop through the hole on the rear safe guard and hook the loop over the cord strain relief. Gently pull on the cord to ensure that it is firmly attached.

### **2. Operation**

#### **a. General operation**

- 1) Check the product, its power cord and plug as well as accessories for damage before each use. Do not use the product if it is damaged or shows wear.
- 2) Double check that accessories or cutting device are properly fixed.
- 3) Always hold the product on its handles. Keep the handles dry to ensure safe support.

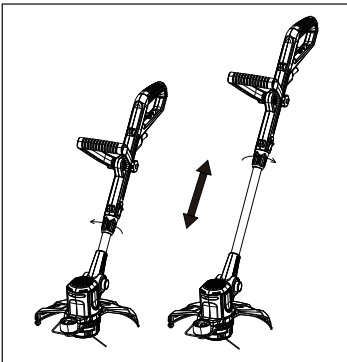

#### **b. Height adjustment**

- 1) Loosen the locking sleeve counter clockwise.
- 2) Adjust the pole length to fit your body height.
- 3) Tighten the locking sleeve anti-clockwise.

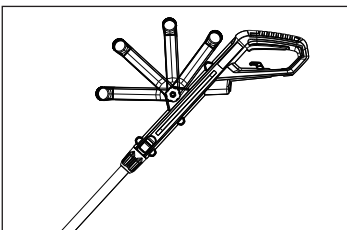

#### **c. Handle adjustment**

Adjust the angle of the auxiliary handle to ease operation and prevent loss of control.

- 1) Loosen the knob and move the handle up or downward.
- 2) Tighten the knob to secure the auxiliary handle in the adjusted position.

#### **d. Tilt adjustment**

Adjust the vertical angle of the trimmer head to fit the trimming conditions.

- 1) Press the tilt adjustment buttons at the both sides of trimmer.

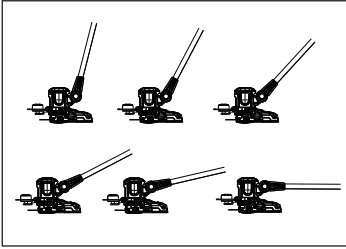

- 2) Adjust the angle of the pole, up or down.
- 3) Release the unlock button and keep moving the pole until it locks in place.



**NOTE: Always ensure that the unlock snaps into place after adjusting the trimmer in one of the 6 positions!**

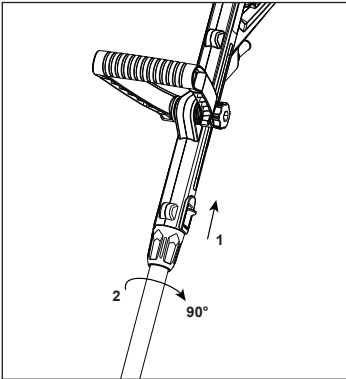

### e. Edging

- 1) Adjust the vertical angle of trimmer head to 0 degree by pressing the tilt adjustment button.
- 2) Adjust the trimmer head to 90 degrees for edging by pressing the locking button.
- 3) Uplift the plant protector to an angle of 90°.

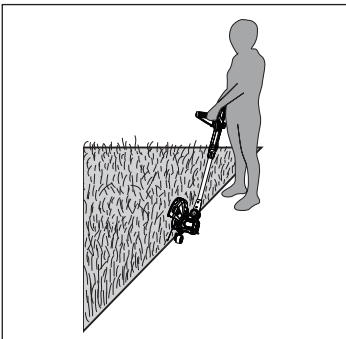
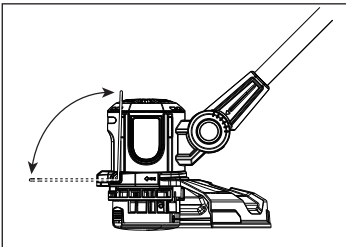



#### **f. Automatic line feeding**

The equipment features a fully automatic dual line system. The lines will automatically elongate every time you turn on the appliance. To support proper line elongation, ensure that the coil has stopped moving completely before turning on the appliance again.

The lines are automatically cut to the correct length by the line cutter.

#### **g. Plant protector**

Use the plant protector to keep distance to plants like flowers, trees or other objects that could be hit by the cutting device.

- 1) Fold the plant protector out for trimming / edging operation.
- 2) Fold the plant protector in for storage.



**WARNING! Adjust the plant protector position only when the product is switched off and the cutting device is at a complete stop!**

#### **h. Switching on/off**

- 1) Connect the plug to the mains socket- this product runs on 240V.
- 2) Press the on/off switch to turn the product on.
- 3) Release the on/off switch to turn the product off.

#### **i. Trimming**

- 1) Ensure the knife protector label is removed before use. Ensure you wear gloves when removing this label.
- 2) Adjust the trimmer head angle to a proper position for trimming operation.
- 3) Hold the grass trimmer firmly, keeping your balance with feet slightly apart. Alter the height of the product if needed to ensure an upright posture.
- 4) Hold the trimmer head just above the ground at an angle of approximately 30°.
- 5) Move the product slowly from side to side in a swinging motion.
- 6) Ensure the cutting device remains clean and free from off-cuts that may cause it to jam. Check regularly. Release the on/ off switch and disconnect the product from the power supply before checking.
- 7) Trim longer grass in stages; do not cut long grass in one cut. For the best results, cut longer grass in steps.
- 8) Place the trimmer along the edge of the lawn.
- 9) Turn product on and push the trimmer forward slowly.

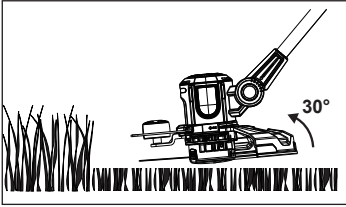

**WARNING!**

Always fit the guard before using the product  
When cutting longer/ higher grass, please make sure that you cut this down in 2 to 3 stages.

**DO NOT** cut long grass in one cut, as this will damage your grass trimmer and make your warranty invalid.

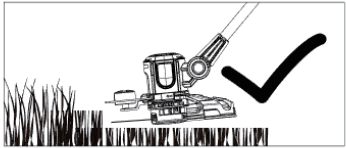

**j. Tips**

- 1) For best results, do not cut wet grass as it tends to stick to the cutting head and guard, prevents proper discharge of grass trimmings, and could cause you to slip and fall.
- 2) Do not allow the spool cover to drag on the ground or other surfaces.
- 3) Pay special attention when performing the work close to trees and bushes. The cutting head could damage sensitive bark, and damage fence posts.
- 4) Fold the plant protector out to avoid bringing the cutting device into contact with hard objects such as walls and kerbstones.

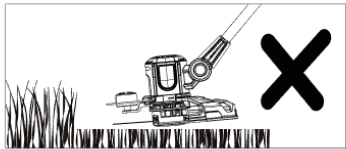

**NOTE:** The trimming line will wear faster and require more feeding if the cutting or edging is done along sidewalks or other abrasive surfaces or heavier weeds are being cut.

## CARE AND CLEANING

### 1. Maintenance



**Note.** This product does not contain any parts that can be repaired by the consumer. Contact an authorised service centre or a similarly qualified person to have it checked and repaired.

#### a. Replacing the spool



**NOTE:** Before replacing the spool, make sure the mains plug is disconnected from the unit.

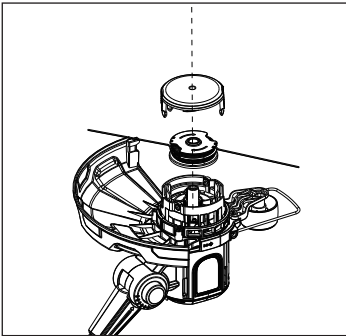

- 1) Press together both locking device tabs on the spool cover and remove the cover.
- 2) Remove the old spool from the spool cover.
- 3) Clean out any dirt or grass residue.
- 4) Put the new spool in the spool housing, thread the line into the hole.

#### b. Winding the line



**NOTE:** Should you wish to wind the line yourself, the instructions are provided below:

**Self-winding, however, is NOT recommended because if the line is not wound properly it can cause the trimmer's feed system to malfunction.**

**For this reason, users are strongly urged to purchase the pre-wound spool.**

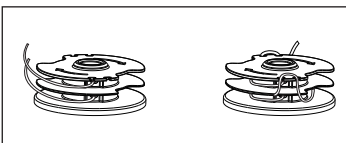

- 1) Hold the loose ends of the line together with one hand, find the center of the line with the other hand and hook this center loop into the groove on the spool.
- 2) Wind the line following the directional arrows on the spool housing and hook the two ends into the side grooves.

## 2. Storage

- a. Store the product and its accessories in a dry, frost-free place.
- b. Always store the product in a place that is inaccessible to children. The ideal storage temperature is between 10°C and 30°C.

## 3. Transportation

- a. Switch the product off and disconnect from power supply before transporting it anywhere.
- b. Protect the product against scratching and secure it to avoid damage from impact.

## 4. After use

- a. Switch the product off, disconnect it from the power supply and let it cool down.
- b. Fold the plant protector in.
- c. Check, clean and store the product as described below.

# TROUBLE SHOOTING

Use this section to help you to try and solve any problems you may have:

PROBLEM	POSSIBLE CAUSES	REMEDIES
1. Product does not start	<ul style="list-style-type: none"><li>• Not connected to power supply</li><li>• Power cord or plug is defective</li><li>• Other electrical defect to the product</li></ul>	<ul style="list-style-type: none"><li>• Connect to a proper power supply.</li><li>• Call after sales support at +44 01904 947568</li></ul>
2. Product does not reach full power	<ul style="list-style-type: none"><li>• Extension cord is not suitable for this product</li><li>• Power source (e.g. generator) has too low a voltage</li><li>• Air vents are blocked</li></ul>	<ul style="list-style-type: none"><li>• Use a proper extension cord</li><li>• Connect to another proper power supply</li><li>• Clean the air vents</li></ul>
3. Unsatisfactory result	<ul style="list-style-type: none"><li>• Line spool does not have sufficient line</li><li>• Line has not been conducted out of the spool or only one side</li></ul>	<ul style="list-style-type: none"><li>• Lengthen cutting line or exchange a new spool</li><li>• Remove spool and place line through opening outwards</li></ul>

# DECLARATION OF CONFORMITY / PERFORMANCE



**Product Code: 90598(DT4302)**

**Product Description: Hawksmoor 450W 30cm Electric Grass Trimmer**

1. Toolstation Limited, Express Park, Bristol Road, Bridgwater, Somerset TA6 4RN

This declaration of conformity is issued under the sole responsibility of Toolstation

2. Object of the declaration

The object of the declaration described above is in conformity with the relevant Community harmonization legislation:

Supply of Machinery (Safety) Regulations 2008

2006/42/EC

Electromagnetic Compatibility Regulations 2016

2014/30/EU

Electrical Equipment (Safety) Regulations 2016

2014/35/EU

The Restriction of the Use of Certain Hazardous Substances in Electrical and Electronic Equipment Regulations 2012

2011/65/EU&(EU)2015/863

Noise Emission in the Environment by Equipment for use Outdoors Regulations 2001

2000/14/EC amended by 2005/88/EC

2000/14/EC amended by 2005/88/EC:

-Conformity Assessment Procedure as per Annex VI

-Measured Sound Power Level 92 dB(A)

-Declared Guaranteed Sound Power 96 dB(A)Level

3. References to the relevant standards used (or references to the specifications in relation to which conformity is declared:

BS EN 60335-1, BS EN 50636-2-91, BS EN 62233, BS EN ISO 3744, BS EN 55014-1,

BS EN 55014-2, BS EN 61000-3-2, BS EN 61000-3-3

4. Additional information:

Signed for and on behalf of Toolstation Limited

## ENVIRONMENTAL INFORMATION



When your product comes to the end of its life or you choose to update or upgrade it by replacing it, please do not dispose of it with your normal household waste. Please recycle where facilities exist. When you need to dispose of this product, check with your retailer or local authority for suitable options. Regulations encourage the recycling of Waste from Electrical and Electronic Equipment (DIRECTIVE 2012/19/EU OF THE EUROPEAN PARLIAMENT AND OF THE COUNCIL of 4 July 2012 on waste electrical and electronic equipment (WEEE)).

## GUARANTEE

Toolstation products deliver reliable service for normal, household use in domestic settings. All Toolstation products are individually tested before leaving the factory.

If you are a consumer and you experience a problem with your Toolstation product, which is found to be defective due to faulty materials or workmanship within the Guarantee Period, this Toolstation Guarantee will cover repair or - at the discretion of Toolstation - replacement with a functionally equivalent Toolstation product.

Your product is under guarantee for 2 year from the date of purchase or the date of delivery of the product, if later.

The guarantee is subject to the following provisions:

- The guarantee does not cover accidental damage, misuse, cabinet parts, knobs, or consumable items.
- The product must be correctly installed and operated in accordance with the instructions contained in this manual.
- It must be used solely for domestic purpose.
- The guarantee will be retendered invalid if the product is re-sold or has been damaged by inexpert repair.
- Specifications are subject to change without notice.
- The manufacturer disclaims any liability for the incidental or consequential damages.
- The guarantee is in addition to, and does not diminish your statutory or legal rights.

## CUSTOMER SUPPORT

[www.coreservice.co.uk](http://www.coreservice.co.uk)

Call us +44 01904 947568

Email: [support@coreservice.co.uk](mailto:support@coreservice.co.uk)

Made in China