

Original User's Instructions

33cc 42cm Petrol Brush Cutter

SKU: 51405

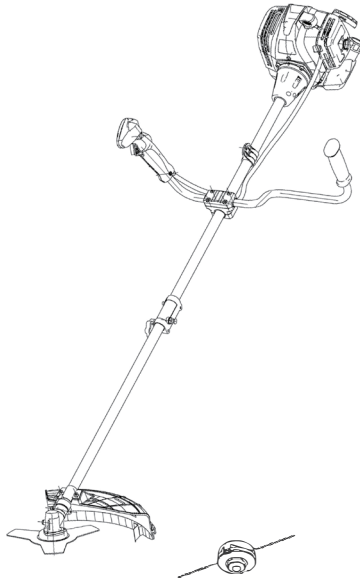

WHAT'S IN THE BOX

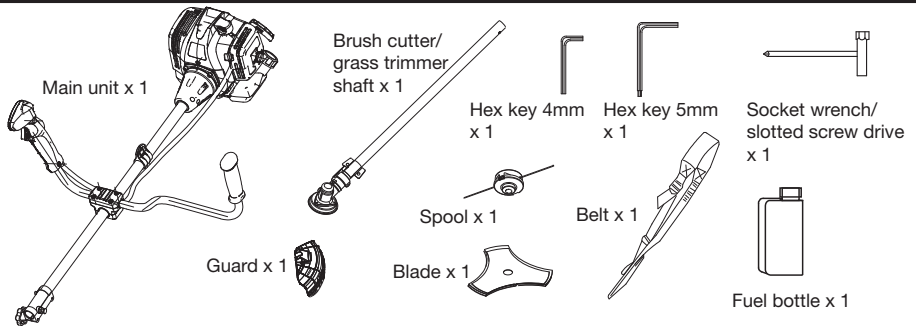

If you do not have all these items, please contact:
www.coreservice.co.uk
Hotline: +44 01904 947568
Email support@coreservice.co.uk

PLEASE KEEP THESE INSTRUCTIONS FOR FURTHER REFERENCE

SPECIFICATION

Technical Data	
Model	CG330FHB
Engine Type	2-Stroke Euro V
Displacement	33 cm ³
Max. Cutting speed	6500 rpm(grass trimmer)/7000 rpm (brush cutter)
Rated Power	0.9 kw
Metal Blade size	1.4 x 255 x 25.4 mm
Nylon Line Cutting Head (Max. Cut)	420mm(grass trimmer)/255mm(brush cutter)
Nylon Line size	2 mm
Fuel Capacity	0.7 L
Fuel/Oil Ratio	40:1
Easy Start	Yes
Net Weight	7.2 kg
Spark plug	RCJ6IY
Value of Vibration	a front_hv,eq: max. 10.0 m/s ² ,K=1,5m/s ² a rear_hv,eq: max. 9.0 m/s ² ,K=1,5m/s ²
Sound Power	L _{WA,eq} :108.7dB(A) K=3dB(A)
Sound Pressure Uncertain K	L _{pA,eq} : 93dB(A) Uncertain K _{pA} =3,0dB(A)

EXPLANATIONS AND SYMBOLS, CAUTIONS AND WARNINGS



Symbol warning of a warning



Read and refer to these operating instructions



Wear safety equipment that includes a helmet, protective helmet and protective goggles



Guarantee sound power level



Keep all children, bystanders and helpers 15 meters away from the machine.



The machine shall not be used in any position that causes any part to come within 10 m of overhead electrical lines.



Beware of blade trust. Blade is continually in motion.



Caution! Risk of injury due to running blades!



Beware of recoil!



Caution! Risk of suffocation!



Fire, naked flames and smoking are prohibited!



Warning! Do not use circular saw blades for the cutting blade function.



Protect the appliance from rain and moisture!



Beware of thrown objects



Maximum cutting speed with blades



Maximum cutting speed with string



Wear respiratory protection.



Wear protective gloves



Wear protective foot wear.



The port to refuel the "MIX GASOLINE"
Position: FUEL TANK CAP



The direction to close the choke
Position: TOP COVER



The direction to open the choke
Position: TOP COVER



Keep all parts of your body away from hot surfaces



The product complies with the applicable European directives and an evaluation method of conformity for these directives was done.



A product placed on the United Kingdom market meets the UKCA Marking requirements

SAFETY INSTRUCTIONS

TRAINING

- A. Read the instructions carefully. Get familiar with the controls and proper use of the tool.
- B. Only use the tool for the purpose for which it was designed. Any other use can be hazardous and may also cause damage to the tool.
- C. Never allow children or people unfamiliar with these instructions to use the tool. Local regulations may restrict the age of the operator.
- D. Never use the tool:
 - When people, especially children, or pets are nearby.
 - If the operator has taken medicine or substances that can affect his ability to react and concentrate.
- E. Remember that the operator or user is responsible for accidents or hazards occurring to other people or their property.



WARNING! Proper safety precautions must be observed. Like all power equipment this tool must be handled carefully. DO NOT EXPOSE YOURSELF OR OTHERS TO DANGER. Follow these general rules. Do not permit others to use this tool unless they are trained in its operation.



WARNING! THIS TOOL CAN CAUSE SERIOUS INJURIES. Read the instructions carefully for the correct handling, preparation, maintenance, starting and stopping of the tool. Be familiar with all controls and the proper use of the tool.

GENERAL SAFETY INSTRUCTIONS

- A. Never allow children to use the tool.
- B. Beware of overhead power lines.
- C. Do not use the tool while people or children are nearby. Keep at least 15 metres away.
- D. Dress properly! Do not wear loose clothing or jewellery, which can be caught in moving parts.
- E. Use of sturdy gloves, nonskid footwear hearing protection and safety glasses.
- F. Use extra care when handling fuels. They are ammable and the vapours are explosive.
- G. The following points should be observed:
 - Use only an approved fuel container.
 - Never remove the fuel cap or add fuel with the engine running.
 - Allow engine and exhaust components to cool down before refuelling.
 - Do not smoke.
 - Never refuel indoors.
 - Never store the tool or fuel container inside where there is an open ame, such as near a water heater.
 - If fuel is spilled, do not attempt to start the engine, move the tool away from the spillage before starting.
 - Always replace and securely tighten the fuel cap after refuelling.
- H. If the tool starts making any unusual noise or vibration. Turn OFF the engine and allow the tool to stop and take the following steps:
 - Inspect for damage:
 - Check for and tighten any loose parts;

- Have any damaged parts replaced repaired with parts having equivalent specifications

WHEN USING THE TOOL

- A. Stop the engine before:
 - Cleaning or when clearing a blockage.
 - Checking, carrying out maintenance or working on the tool.
 - Adjusting the working position of the cutting device.
 - Leaving the tool unattended.
- B. Ensure that the tool is correctly located in a designated working position before starting the engine.
- C. While operating the tool always ensure that the operating position is safe and secure, especially when using steps or a ladder.
- D. To reduce fire hazards keep the engine and silencer free of debris, leaves and excessive lubricant.
- E. Always ensure that all handles and guards are fitted when using the tool. Never attempt to use an incomplete tool or one fitted with an unauthorised modification.
- F. Always be aware of your surroundings and stay alert for possible hazards of which you may not be aware due to the noise of the tool.
- G. Keep fuel in a suitable container specially made for this purpose.

ADDITIONAL SAFETY RULES FOR PETROL BRUSH CUTTER



WARNING! Beware of kickback.

KICKBACK

Take care using the metal blade with the tool. Kickback is a reaction that occurs when the blade hits objects that it can not cut. This can

make the blade push away from the object or run along the object. This reaction can be intense enough to lose control of the tool and can occur without a warning.

The operator should cut from right to left to minimize the chance of kickback.



WARNING! Dress appropriately.

- A. Always use the brush cutter with the shoulder strap.
- B. Do NOT use saw blades. Use only blades designed for use with brush cutters.
- C. Do not operate with loose clothing or long hair. These can be sucked into the air intake of the tool.
- D. While using, always wear sturdy footwear and long trousers. Do not operate the equipment with bare feet or open sandals.
- E. Do not operate in a hazardous location. Such areas include where there is a risk of explosion of fumes, leaking gas or explosive dust.
- F. Do not operate in a confined area. Exhaust gases, smoke or fumes could reach dangerous concentrations.
- G. Protect your tool. This tool is NOT WEATHERPROOF and should not be exposed to direct sunlight, high ambient temperature and damp, wet or high humidity conditions.
- H. Do not smoke or use a mobile phone while refuelling. This is potentially dangerous as it may ignite the fuel and cause an explosion.
- I. Take care not to spill fuel. When refuelling the tool ensure that the engine has been switched off. Prevent the spilling of fuel as this may also ignite with the hot engine. Never refuel whilst the engine is running.
- J. Be careful where you store the tool. Store the tool in a dry area away from ammable liquids.

- K. Keep your distance. The tool emits exhaust fumes.
- L. Ensure you use fuel oil mix. Ensure that you mix 40 parts unleaded fuel to 1 part two stroke oil, if not the engine will overheat and cause damage to your tool.
- M. Never fill fuel tank indoors.
- N. Never fill fuel tank when engine is running or hot.
- O. Stop the engine before re-fuelling.
- P. Stop the engine and disconnect the spark plug wire If the tool starts to vibrate abnormally (find and remove the cause of the vibration immediately).
- Q. Reduce the throttle before turning off the engine.
- R. The user is responsible for the safety of other people, animals and objects in the working area. Keep people, children and domestic

ASSEMBLY AND USE

BEFORE THE BRUSH CUTTER CAN BE USED IT REQUIRES SOME ASSEMBLY.

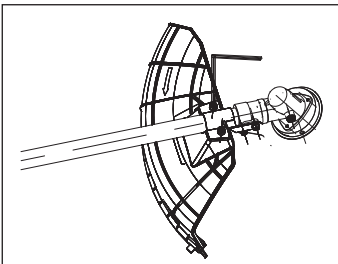

INSTALLING THE GUARD

- With the 5 mm Hex key. Remove the two screws from the top of the guard.
- Hold the Guard underneath the bracket, insert the two screws through the bracket in to the holes in the guard and retighten firmly.

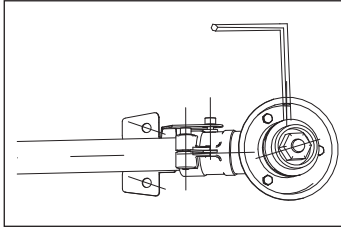

FITTING THE BLADE

- Lock the shaft by Inserting the 5mm hex key through the hole and into the blade mounting boss as shown.

NOTE: The flange nut has a left hand thread.

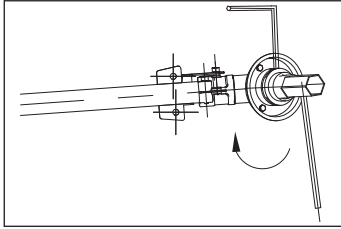

- Remove the flange nut using the Spark plug spanner by turning it in a clockwise direction.

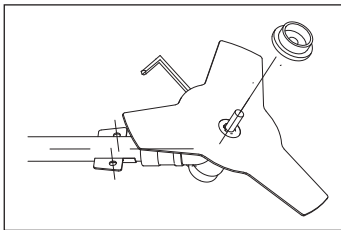

- Remove the top flange and mount the blade on the centre boss.
- Replace the flange and make sure that the blade stays correctly mounted.

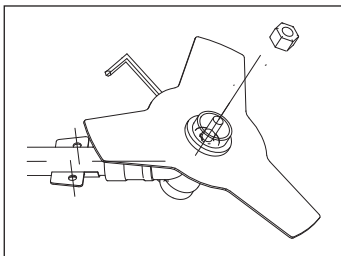

- Replace the flange nut.

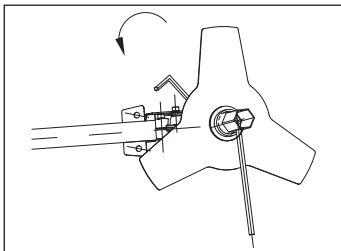

- Tighten the flange nut firmly anti-clockwise.
- Remove the Hex key to unlock the shaft.

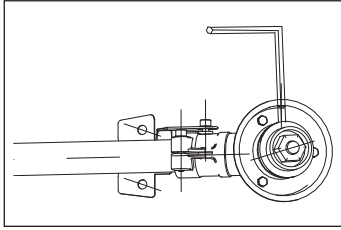

TO USE THE LINE TRIMMER HEAD

- Lock the shaft by Inserting the 5mm hex key through the hole and into the blade mounting boss as shown.

NOTE: The flange nut and spindle have left hand threads.

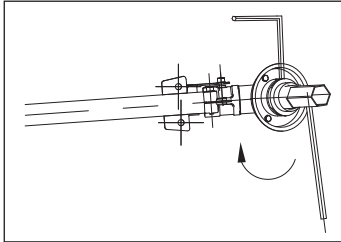

- Remove the flange nut using the Spark plug spanner (J) by turning it in a clockwise direction.
- Remove the top flange.

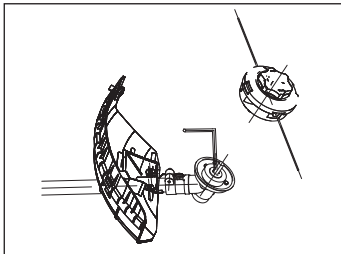

- Mount the line trimmer head onto the spindle.

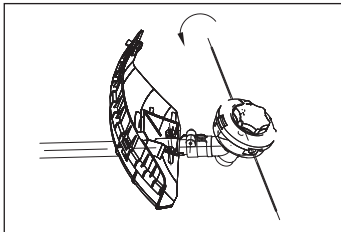

- Tighten the line trimmer head in an anti-clockwise direction.

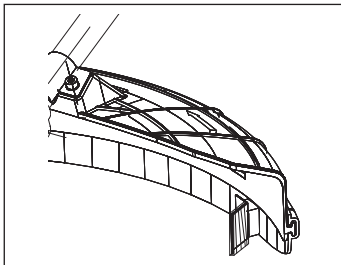

- On the underside of the guard, remove the protective cover on the line cutting blade.
- Remove the hex key to unlock the shaft.
- Store the top flange and flange nut in a safe place in case they are needed for later use.

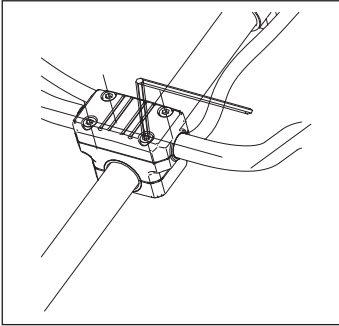

INSTALL THE HANDLES

- Using the 4 mm hex key, loosen the four screws on the handle bar clamp.
- Pass the right hand handle under the upper shaft and insert the right handle approximately 30 mm into the clamp.

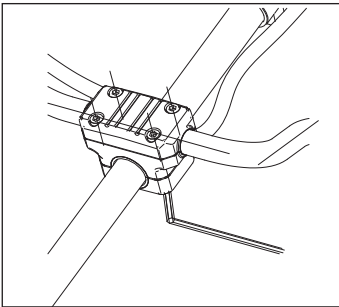

- Insert the left handle bar into the clamp approximately 30 mm.
- Gently tighten the clamp screws.
- Adjust the position of the handles to be comfortable for operation.
- Firmly tighten all the handlebar clamp screws.

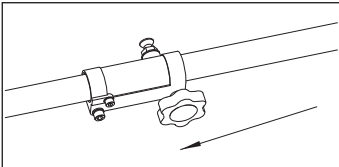

JOIN THE UPPER AND LOWER SHAFTS

- Line up the button on the lower shaft with the hole in the shaft clamp and insert the lower shaft into the clamp until the button clicks into the hole in the clamp.

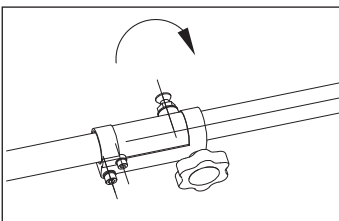

- Firmly tighten the knob on the clamp.

NOTE: Whilst inserting the shaft into the joining clamp the lower shaft may need to be rotated a bit so the internal shaft components can engage correctly.



WARNING! Always use the brush cutter with the shoulder belt.

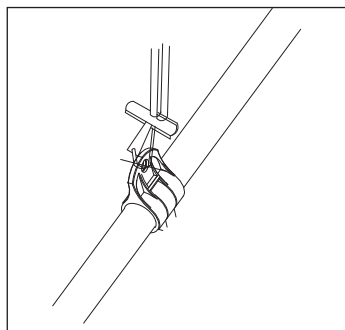

ATTACH THE SHOULDER BELT

The brush cutter must always be used with the shoulder belt.

- Clip the hook on shoulder strap to the strap attachment point (5).

FUEL

USE FRESH UNLEADED FUEL (PETROL), 90 OCTANE OR BETTER – Do NOT use E10 or Ethanol blends. Mix with a premium grade air cooled 2 stroke oil at a ratio of 40:1

Mix fuel with 2 stroke oil in an approved container. Shake gently and ensure a thorough mix.



WARNING! Fuel is very flammable. Use extreme care when mixing, storing or handling fuel or serious personal injury may result.



CAUTION! Never use raw fuel without oil in your unit. This will cause permanent engine damage and void the warranty for that product.

Never use a fuel mixture that has been stored for over 90 days.



CAUTION! The 2 stroke oil must be a premium grade oil for 2-cycle air cooled engines and must be mixed at a 40:1 ratio with the fuel.

Mixing the fuel at a greater ratio than 40:1 provides insufficient lubrication and will cause engine damage and voids your warranty.

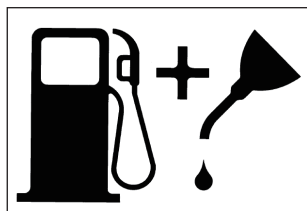

Mixed 40:1

Unleaded Plus 2 stroke oil.

FUELING



WARNING! Always shut off engine before fuelling. Never add fuel to a machine with a running or hot engine.

Do not SMOKE! Failure to heed this warning could result in serious personal injury.



WARNING! Always ensure there is adequate ventilation when handling fuel.

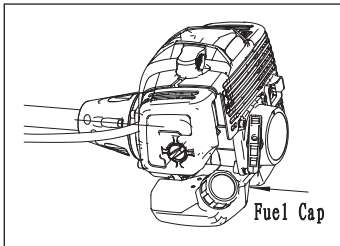

- Place the brush cutter upright on the ground or on a sturdy bench and wipe any debris from around the fuel cap.
- Unscrew the fuel tank cap and pour the mixture into the tank using a funnel (not supplied).
- Be careful not to spill any mixture. If this happens, wipe the spill with a clean rag.
- Start the engine at least three metres away from the area where the fuel tank has been filled up in order to reduce risk of fire.

A factory-new machine should run at moderate speed for the first 2-3 hours of work, as different components need to settle with each other during the process of running in the engine.

The engine can reach its maximum power after this running in period.

After the first 2-3 hours of works, stop and make sure that all nuts and screws are securely fastened, and tighten them if necessary.

NOTE. It is normal for smoke to be emitted from a new engine during and after first use.

STARTING THE BRUSH CUTTER

- Press the primer bulb located at the bottom of the air filter until the primer bulb fills with the fuel mixture.

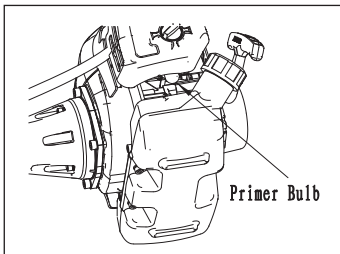

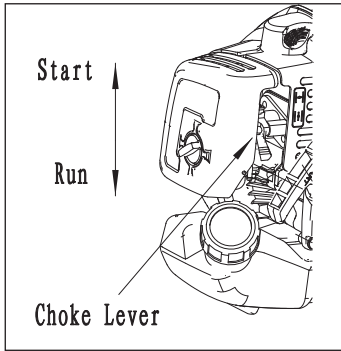

- Move the choke lever to the start position.

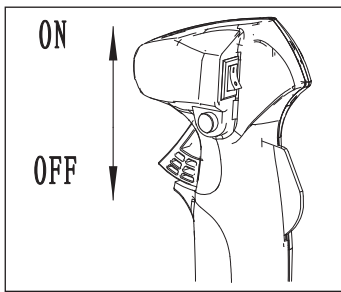

- Set the ON/OFF switch (14) to the ON position.

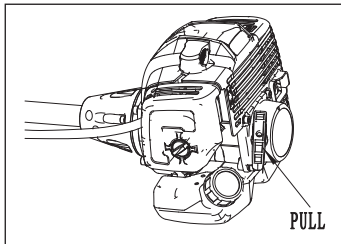

- Briskly pull the starter until the engine splutters. (This may take up to 10 pulls).
- Immediately move the choke lever to the run position.
- Pull the starter again until the engine starts.

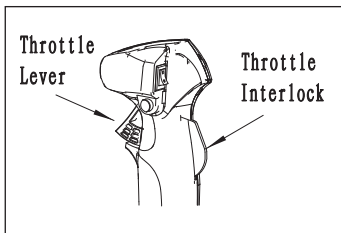

- Grasp the right handle with your right hand to depress the throttle interlock (15) and squeeze the throttle lever (16) to increase the speed of the engine.



WARNING! If the brush cutter vibrates excessively. STOP the engine immediately and investigate the cause.

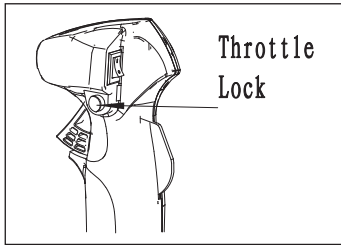

- When the throttle lever is depressed approximately 50% the throttle lock button (13) can be pressed if required. This will hold the throttle at this point.
- To disengage the throttle lock squeeze the throttle lever fully and release.

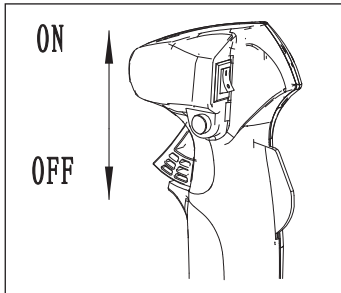

TO STOP THE ENGINE.

- Move the ON/ OFF switch to the OFF Position.



WARNING! Read and understand all of the safety warning in this manual before operating the brush cutter.



WARNING! Beware of kickback.



WARNING! Always position the brush cutter on the operator's right hand side when using.



WARNING! The operator must keep at least 15 metres away from bystanders when using the brush cutter.

USING THE BRUSH CUTTER WITH THE BLADE.

- Hold the brush cutter with the right hand on the throttle lever and the left hand on the left handle.
- Keep a firm grip with both hands while in operation. Brush cutter should be held at a comfortable position with the right handle about hip height.
- Maintain your grip and balance on both feet. Position yourself so that you will not be drawn off balance by the kick-back reaction of the cutting blade.
- Adjust the shoulder strap to position the brush cutter at a comfortable operating position and to assure that the shoulder strap will reduce the risk of operator contact with the blade.
- Inspect and clear the area of any hidden objects such as glass, stones, concrete, fencing, wire, wood, metal, etc.
- Never use blades near footpaths, fencing, posts, buildings or other immovable objects.

The brush cutter should be used like a scythe, cutting from the right to the left in a broad sweeping action.

- The blade is suited only for weeds and vines. When the blade becomes dull, it can be turned over to extend the life of the blade.

Do not sharpen the blade.

USING THE TOOL AS A LINE TRIMMER.

- Keep the trimmer tilted toward the area being cut. This is the best cutting area.
- Cut from right to left and from the top down. This reduces the amount of debris thrown at the operator and reduces the risk of the entanglement.

NOTE. If grass becomes wrapped around the spool, stop the engine, and remove the grass.

FEEDING THE LINE

The line trimmer has a bump feed mechanism which releases the line without having to stop the engine.

- To release additional line, lightly tap the line trimmer spool on the ground while operating the unit at high speed. Never bump the spool head on concrete as it may crack the spool housing.

NOTE. Always keep the line fully extended. Line release becomes more difficult as the cutting line becomes shorter. Each time the line trimmer spool is bumped it releases approximately 2cm of line. Release the line until it strikes the line cutting blade. This may require several taps.

CARE AND CLEANING

BEFORE EACH USE

- Remove dirt and debris from the tool exterior.
- Check all screws for tightness and tighten if necessary.
- Check blade flange nut is tight and tighten if necessary.
- Check the blade for damage. Replace if damaged or cracked.
- Inspect the engine, tank and hoses for possible fuel leaks, and repair as necessary.
- Inspect the engine cooling fins for accumulations of dirt or debris, and clean as necessary.

EVERY 10~15 HOURS OF USE

- Loosen and remove the air filter cover and filter element.
- Inspect the element. If the filter element is distorted or damaged, replace it with a new one.
- Wash the filter element in clean fuel, and squeeze or blow dry.
- Reinstall the filter element and air filter cover to the tool.
- Use the spark plug wrench to remove the spark plug (turn anticlockwise to remove).
- Clean and adjust the spark plug gap to 0.6-0.7 mm. Replace any damaged or visibly worn plug with a RCJ6Y spark plug or equivalent.
- Reinstall the spark plug by hand, then tighten it firmly with the spark plug wrench.

EVERY 50 HOURS OF USE

- **INSPECTION** Inspect the entire tool and tubes for damage including loose or missing components and repair as necessary.
- **SPARK PLUG** Replace the spark plug with a RCJ6Y spark plug or equivalent.
Gapped to (0.6-0.7) mm.
- **FUEL FILTER** Use a wire hook to extract the fuel filter from inside the fuel tank, and then remove and wash the filter element in clean fuel. Before reinstalling the filter, inspect the condition of the fuel line.

If damage or deterioration is noted, the tool should be removed from service until it can be inspected by a trained service technician.

STORAGE (30 DAYS OR LONGER)

- **CLEANING** - Thoroughly clean the tool exterior.
- **INSPECTION** - Inspect the entire tool for damage, including loose or missing components and repair as necessary.
- **FUEL** - Drain the fuel tank and then clear the carburettor and lines by running the tool until it stops from lack of fuel.
- **LUBRICATION** - Remove the spark plug and then pour approximately a teaspoon of 2 stroke oil into the cylinder through the spark plug hole. Before reinstalling the spark plug, pull the starter 2 or 3 times to distribute the oil over the cylinder walls.
- **AIR FILTER** - Remove, clean and reinstall the filter element.
- **STORAGE** - Store the tool in a clean, dry, dust-free environment.

TROUBLE SHOOTING

Use this section to help you to try and solve any problems you may have:

PROBLEM	POSSIBLE CAUSE	REMEDY
Engine fails to start.	No fuel in tank.	Fill fuel tank.
	Fuel system not primed.	Press primer bulb 3-5 times until fuel system is full of fuel.
	Choke not engaged.	Use choke when starting.
	Spark plug is fouled.	Replace spark plug.
	No Spark.	Turn ignition switch to ON position.
	Engine is flooded.	Remove the spark plug and leave for 1 hr. Replace the spark plug and try again.
Engine hard to start.	Water in fuel or stale fuel.	Drain fuel and replace with fresh fuel.
	Spark plug.	Service spark plug.
Engine lacks power.	Air filter clogged.	Clean the air filter.
Engine run hot.	Incorrect fuel mixture.	Replace fuel with correct mix 40:1.

NOTE: IF YOU EXPERIENCE A PROBLEM WITH YOUR PRODUCT, PLEASE DO NOT ATTEMPT TO OPEN OR REPAIR THE PRODUCT YOURSELF. DOING SO MAY VOID THE WARRANTY AND COULD CAUSE DAMAGE OR PERSONAL INJURY. IF THE PROBLEM STILL PERSISTS, PLEASE CONTACT US BY REFERRING TO THE SERVICE & SUPPORT INFORMATION ON THE FOLLOWING PAGE.

DECLARATION OF CONFORMITY / PERFORMANCE



Product Code: 51405/CG330FHB

Product Description: Hawksmoor 33cc 42cm Petrol Brush Cutter

1. Toolstation Limited, Express Park, Bristol Road, Bridgwater, Somerset TA6 4RN

This declaration of conformity is issued under the sole responsibility of Toolstation

2. Object of the declaration

The object of the declaration described above is in conformity with the relevant Community harmonization legislation:

Supply of Machinery (Safety) Regulations 2008

2006/42/EC

Electromagnetic Compatibility Regulations 2016

2014/30/EU

The Restriction of the Use of Certain Hazardous Substances in Electrical and Electronic Equipment Regulations 2012

2011/65/EU&(EU)2015/863

Noise Emission in the Environment by Equipment for use Outdoors Regulations 2001

2000/14/EC amended by 2005/88/EC:

- | | |
|--|-----------|
| - Conformity Assessment Procedure as per | Annex V |
| - Max. Sound Pressure Level | 97 dB(A) |
| - Declared Guaranteed Sound Power Level | 114 dB(A) |

3. References to the relevant standards used (or references to the specifications in relation to which conformity is declared:

BS EN ISO 11806-1, BS EN ISO 14982

4. Additional information:

Signed for and on behalf of Toolstation Limited

ENVIRONMENTAL INFORMATION



When your product comes to the end of its life or you choose to update or upgrade it by replacing it, please do not dispose of it with your normal household waste. Please recycle where facilities exist. When you need to dispose of this product, check with your retailer or local authority for suitable options. Regulations encourage the recycling of Waste from Electrical and Electronic Equipment (DIRECTIVE 2012/19/EU OF THE EUROPEAN PARLIAMENT AND OF THE COUNCIL of 4 July 2012 on waste electrical and electronic equipment (WEEE)).

GUARANTEE

Toolstation products deliver reliable service for normal, household use in domestic settings. All Toolstation products are individually tested before leaving the factory.

If you are a consumer and you experience a problem with your Toolstation product, which is found to be defective due to faulty materials or workmanship within the Guarantee Period, this Toolstation Guarantee will cover repair or - at the discretion of Toolstation - replacement with a functionally equivalent Toolstation product.

Your product is under guarantee for 2 year from the date of purchase or the date of delivery of the product, if later.

The guarantee is subject to the following provisions:

- The guarantee does not cover accidental damage, misuse, cabinet parts, knobs, or consumable items.
- The product must be correctly installed and operated in accordance with the instructions contained in this manual.
- It must be used solely for domestic purpose.
- The guarantee will be rendered invalid if the product is re-sold or has been damaged by inexpert repair.
- Specifications are subject to change without notice.
- The manufacturer disclaims any liability for the incidental or consequential damages.
- The guarantee is in addition to, and does not diminish your statutory or legal rights.

CUSTOMER SUPPORT

www.coreservice.co.uk

Call us +44 01904 947568

Email: support@coreservice.co.uk

Made in China