

Original User's Instructions

33cc Petrol Multi-Tool

SKU: 62625

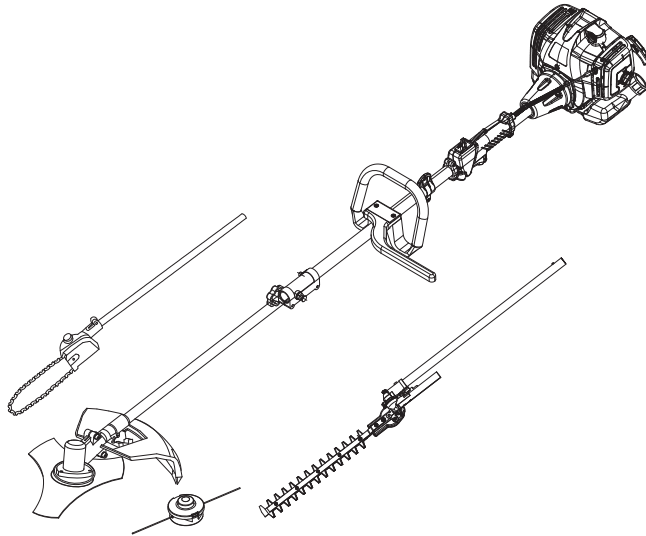

WHAT'S IN THE BOX

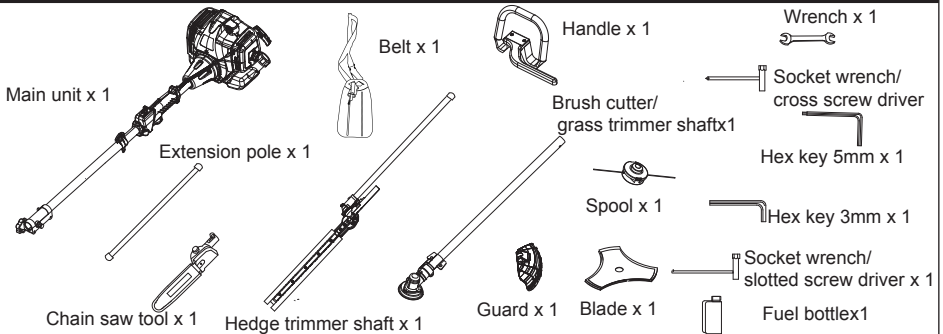

If you do not have all these items, please contact:

www.coreservice.co.uk

Hotline: +44 01904 947568

Email support@coreservice.co.uk

PLEASE KEEP THESE INSTRUCTIONS FOR FURTHER REFERENCE

SPECIFICATION

Technical Data	
Model	DGJ330H
Type of engine	1E36FN (air cooled 2-stroke engine)
Idle speed of the engine	2800 min ⁻¹
Engine speed with cutter running	4000 min ⁻¹
Maximum power	0.9 KW
Displacement	33 cm ³
Maximum engine power speed	7000 min ⁻¹
Maximum engine speed	13000 min ⁻¹
Weight (empty tank, without accessories)	11.35kg
Brush cutter:	
Metal Blade size	1.4X255X25.4mm
Cutting dia.	255mm
Grass trimmer:	
Line dia.	2.5mm
Line length	2x2m
Trimming dia:	420mm
Pole saw:	
Type of chain	Oregon 91P040X
Type of guide bar	100SDEA318
Cutting length	25cm(10")
Chain pitch	9,525mm(0,375")
Gauge of chain	1,27(0,05")
Sprocket (number of teeth x pitch)	7 x 8,255 mm
Maximal speed of the chain	21,2m/s
Hedge Trimmer:	
Metal Blade size	400mm teeth space 30.5
Cutting width	2cm
Angle adjustable:	12 angle setting
Spark plug	RCJ6Y

Sound Pressure Uncertain K	$L_{pA,eq}$: 97dB(A) Uncertain K_{pA} =3,0dB(A)
Sound power	$L_{WA,eq}$: 108dB(A) K=3 dB(A)
Guaranteed power level	$L_{WA,d}$: 117dB(A) (2000/14/EC)
Value of vibration	a front_hv,eq: max. 7,06 m/s ² ,K=2,8m/s ² a rear_hv,eq: max. 9.78 m/s ² ,K=3,9m/s ²

Specifications are subject to change without notice.

EXPLANATIONS AND SYMBOLS, CAUTIONS AND WARNINGS



Symbol warning of a warning



Read and refer to these operating instructions



Wear safety equipment that includes a helmet, protective helmet and protective goggles



Guarantee sound power level



Keep all children, bystanders and helpers 15 meters away from the machine.



The machine shall not be used in any position that causes any part to come within 10 m of overhead electrical lines.



Beware of blade trust. Blade is continually in motion.



Caution! Risk of injury due to running blades!



Beware of recoil!



Caution! Risk of suffocation!



Fire, naked flames and smoking are prohibited!



Warning! Do not use circular saw blades for the cutting blade function.



Protect the appliance from rain and moisture!



Beware of thrown objects



Maximum cutting speed with blades



Maximum cutting speed with string



Wear respiratory protection.



Wear protective gloves



Wear protective foot wear.



The port to refuel the "MIX GASOLINE"
Position: FUEL TANK CAP



The direction to close the choke
Position: TOP COVER



The direction to open the choke
Position: TOP COVER



Keep all parts of your body away from hot surfaces



The product complies with the applicable European directives and an evaluation method of conformity for these directives was done.



A product placed on the United Kingdom market meets the UKCA Marking requirements

HEALTH AND SAFETY

- **WARNING!** When using this type of power tool, basic precautions should always be followed to reduce the risk of fire, electric shock and injury.
- Read all instructions carefully before attempting to use this product and retain these instructions. Be familiar with all the operations described in these operating instructions. This product must be operated and operated by experienced users.
- If you are giving this machine to others, please also provide them with this instructions manual.
- Also read all markings on the product. The symbols on the tools are explained in the manual.
- Use this machine as described in this instruction manual. It is strictly forbidden to use this tool for applications other than those described in this manual.
- Failure to follow these instructions can result serious injuries and, in some cases, death.
- This product is intended for private domestic use only: cutting high grass, undergrowth and light scrub; for cutting grass and small weed; trimming branches in trees; the cutting and trimming of hedges, bushes and flowering shrubs in the home environment. Do not use it for commercial purposes. Any other use which is not expressly permitted in these operating

instructions may damage the appliance and represents a serious risk for the user.

- Never let people unfamiliar with these instructions or children use this product.
- National regulations may limit the use of the machine.
- People under the age of 18 must not use this product
- Keep in mind that the operator or user is responsible for accidents or risks to other persons or their property.
- Do not use the tool if you are drunk, tired, under the influence of drugs or ill. Do not use the tool if you are not in an adequate physical condition.
- This tool is intended for outdoor use. Never use it indoors.
- Always use the machine together with the shoulder harness supplied. Holding with both hands, left hand on the control handle, right hand on the tube grip handle.
- When transporting the machine:
 - Secure the machine during transport to prevent loss of fuel, damage or injury.
 - Use a carrying case to protect the cutter during transport.
- Keep people and animals away from the work area. Children and people who do not know how to use this tool should not touch it and handle it.
- Keep them at least 15 m from the machine during operation,
- Use the product only under daylight or under good artificial light.
- When using the machine, always wear full protective equipment including a helmet, protective mask, ear protection, gloves, non-slip footwear and protective clothing.
- Wear appropriate clothing. Do not wear loose or unbuttoned shirts. Do not wear jewelry that may come in contact with moving parts. If you have long hair, tie them down and wear an appropriate safety helmet.

- Do not operate the product with damaged guards or shields not in place.
- Keep hands and feet of the appliance at all times and especially when turning the appliance off and on.
- Do not use the tool in an area where ventilation is poor. Gas emissions can cause injury.
- Do not work when it rains and in bad weather. Do not use the tool in damp locations.
- Do not use the tool in the presence of flammable liquids or gases.
- Caution: The machine releases gases when it is used. Avoid coming into contact with these gases.
- Keep the work area clear. Before working, inspect the work area and remove any materials or objects that could cause accidents.
- Do not force the tool.
- Use only the accessories supplied or recommended by the manufacturer. Use of other accessories may result in an accident. Read the "Technical Data" section of this instruction manual or ask your dealer for advice.
- Do not lean. Keep a good seating and balance at all times.
- To maintain tools and accessories carefully, keep cutting tools sharp and clean for better and safer performance. Follow the instructions in this manual to lubricate and change accessories.
- Always inspect the machine before and after operation. If the tool is damaged or faulty, stop using the tool and bring it to an authorized service for inspection and repair.
- Turn off the tool after use, when you leave it unattended, when changing these accessories and before servicing.
- Keep handles dry, clean and free from oil and grease.
- Be concentrated when using the tool. Look at what you do, make sense and do not use the tool when you are tired.

- Remove the blade guard before using the tool.
- A damaged guard or other part must be properly repaired or replaced by an authorized service center, unless otherwise specified in this instruction manual.
- Do not use the tool if the starter is not working (if it cannot be turned ON and OFF).
- Place the equipment in a well-lit area on a flat, stable, dry and well-ventilated surface, away from flammable materials and with plenty of space for sparking and sharpening waste.
- Do not allow anyone, especially children, to come within a radius of at least five meters around the work area when all work is in progress.
- Immediately stop the tool in the event of a malfunction of the motor or the ON/OFF button or in case of unusual noise.
- Do not use the tool if the starter is damaged.
- Do not move the chain with your hand with the wheel moving.
- Do not stop the chain with your hands or other objects.
- Treat the chain teeth with caution during operation, they can cause severe cuts.
- When not in use, the machine must be stored in a dry, locked place out of the reach of children.
- Before using the product and after any shock, please check it for signs of wear or damage. Please carry out repairs if necessary.
- Always switch off the machine:
 - Every time you leave the device unattended;
 - Before releasing an obstruction;
 - Before checking, cleaning or working on the product;
 - After hitting a foreign object;
 - Every time the product starts to vibrate abnormally.
- Pay attention to foot and cutting injuries.

- Routines for checking that the cutting attachment stops turning, when the engine idles.
- Inspect and regularly service the product. Repairs should be carried out only by an authorized service center or a similar qualified specialist.
- When not in use, store the product out of the reach of children.
- Children should not play with plastic bags, sheets and small parts! Keep them out of the reach of children. There is a danger of suffocation!
- When transporting the tool, always add the blade guard to the blade. Always carry the tool by holding the handle, never the blade.
- Do not use the product on a slippery surface.
- Do not use the product on steep, slippery slopes.
- When planning your work schedule, allow enough time for rest. Limit continuous use of the device, e.g. use 30 ~ 40 minutes per session, and take 10 ~ 20 minutes of rest between work sessions. Work a maximum of two hours per day
- If the machine has struck foreign objects, check if the tool is damaged and bring it to repair if necessary.
- Do not place any part of the body on the chain when the chainsaw is operating. Before starting the chain saw, make sure that the chain is not in contact with anything. A moment of inattention during use may cause your clothing or body part to stick to the chain.
- Always hold the chainsaw back handle with your right hand and the front handle with your left hand. Hold the chainsaw by inverting your hands increases the risk of personal injury and should never be used.
- When cutting a branch that is under stress, pay attention to the risk of elastic return. When the tension of the wood fibers is released, the spring-loaded limb may strike the operator and / or

project the chain saw out of control.

- Exercise extreme caution when cutting brush and young shrubs. Fine materials can grip the cutting chain and be thrown as a whip in your direction, or you lose balance under the effect of traction.
- Follow the instructions for lubrication, tension and chain change accessories. A chain whose tension and lubrication are incorrect can either break or increase the risk of rebound.
- Stick your feet well, keep a good balance and do not climb on the tree trunk.
- Keep handles dry, clean and free of oil and grease. Oily, greasy grips are slippery and cause loss of control.
- Cut only branch, as well as for pruning and cutting. Do not use the chain saw for any other purpose. For example: do not use it to cut plastic, masonry or construction materials other than wood. Using the chain saw for operations other than those specified may result in hazardous situations.
- Beware of overhead power lines when operating, Maintain a minimum distance of 10 m to overhead power lines.
- Never use the appliance while standing on a ladder.
- Be careful when using the machine during stormy weather. Do not use the machine during lightning, thunderstorms or in bad weather in general.
- To minimise the risk of fire, ensure that the engine and the silencer are free of residues, leaves or leaked lubricant.
- To avoid injuries due to falling branches, do not stand under the branches that you want to cut off. Be aware of branches that may spring back and cause injuries. Work at an angle of approximately 60°.

KICKBACK

- Take care using the metal blade with the tool. Kickback is a reaction that occurs when the blade hits objects that it can not cut. This can make the blade push away from the object or run along the object. This reaction can be intense enough to lose control of the tool and can occur without a warning. The operator should cut from right to left to minimize the chance of kickback.
- If the saw chain jams in the upper edge of the guide rail, the rail can kick back violently towards the operator.
- Any such reaction can lead to you losing control over the saw and possibly injuring yourself. Do not rely solely on the chainsaw's built-in safety devices. As the user of a chainsaw, you can take a number of measures to avoid accidents and injury. A kickback is caused by incorrect use or misuse. It can be avoided by taking proper precautions as given below.
- Hold the unit firmly with both hands, with your thumb and fingers around the handles. Hold your body and arms in a position in which you can withstand kickback forces. If suitable measures are taken, the operator can control the recoil forces. Never let go of the chainsaw.
- This will prevent inadvertent contact with the tip of the rail and allows a better control of the chainsaw in unexpected situations.
- Always use the replacement rails and saw chains specified by the manufacturer. Incorrect replacement rails and saw chains can lead to a tearing of the saw chain and/or kickback.
- Follow the manufacturer's instructions for sharpening and maintenance of the saw chain. Setting the depth stop too low can increase the risk of kickback.
- Do not saw with the tip of the blade. This can lead to kickback.
- Ensure that there are no objects on the ground that you can trip over.

- Kickbacks can occur if the tip of the guide rail touches an object or if the wood bends and the saw chain gets caught in the cut.

Fuel Handling

- Be very careful when handling fuels. They are flammable and the vapors are explosive.
- Use only an approved container.
- Never remove the fuel cap or add fuel while the machine is on or hot. Turn off the unit and allow the engine and exhaust components to cool before refueling.
- Do not smoke near the fuel or the engine.
- Petrol is highly flammable. Store petrol only in the containers provided.
- Never refuel inside a room, refuel outside only.
- Never store the tool and the fuel tray indoors where there is a naked flame spark or pilot light, such as near a water heater.
- If fuel has spilled, do not attempt to start the machine, but rather move it away from the spill before starting to use it. Clean any spills.
- Replace and tighten the fuel tank cap after refueling.
- Do not get fuel on your body, it can cause injury. If you get fuel on your body, use a soap and water to remove the fuel.
- Follow the instructions in this manual for filling the tool with fuel.

During maintenance and storage

- Stop the tool and wait until it stops, pull the spark plug connector off the spark plug, make sure all moving parts have come to a standstill.
- Allow the machine to cool before performing inspection, adjustments, maintenance, servicing and storage.
- Store the tool where fuel vapor will not reach a flame or spark.

- When transporting and storing, always place the tool in its transport guard and protective device on it.
- In the event that any part must be replaced or any maintenance or repair work not described in this manual, please contact a representative from the store nearest authorized servicing dealer for assistance, or cause safety consequences.

Causes of rebounds and prevention by the operator

- Bounce may occur when the spout or end of the chain guide touches an object, or when the wood tightens and pinches the cutting chain in the cutting section.
- The contact of the tip may in some cases cause a sudden reverse reaction by bouncing the chain guide up and back towards the operator.
- Pinching of the cutting chain on the upper part of the chain guide can force the chain guide to the operator abruptly.
- Either of these reactions can result in loss of control of the saw likely to result in a serious personal injury. Do not rely exclusively on safety devices built into your saw. As a chain saw user, all measures should be taken to eliminate the risk of accident or injury during cutting.
- Bounce results from improper use of the tool and / or incorrect operating procedures or conditions and can be avoided by taking the appropriate precautions specified below:
- Hold the machine with both hands firmly with the thumbs and fingers encircling the handles of the unit and place your body and arms to allow you to withstand the rebound forces. The rebound forces can be controlled by the operator, if appropriate precautions are taken. Do not allow the unit to start.
- Do not stretch the arm too far and do not cut above the shoulder height. This helps prevent unintentional end contacts and allows better control of the chain saw in unforeseen situations.

- Use only the manufacturers specified replacement guides and chains. Incorrect replacement guides and chains may cause chain breakage and / or rebound.
- Follow manufacturer's instructions for sharpening and servicing the chain saw. A decrease in the depth gauge level can lead to an increase in rebounds.

Residual risks

Even if you use this product in compliance with all safety requirements, the potential risks of injury and damage remain. The following hazards may arise in the structure and design of this product:

- Always be vigilant when using this product, so you can recognize and manage the risks rather.
- Rapid intervention can prevent serious injury and property damage.
- Turn off and unplug the tool if there are any malfunctions. Have it checked by a qualified professional and have repairs carried out, if necessary, before using it again.
- There are harmful health consequences resulting from the emission of vibrations if the product is used for long periods of time or not properly managed and properly maintained.
- There is risk of injury and property damage due to attachments or broken the sudden impact of hidden objects when using cutting.
- Risk of injury to persons and property caused by flying objects.
- Prolonged use of this product exposes the operator to vibration and can produce so-called "white finger" disease. To reduce the risk, wear gloves and keep your hands warm.
- If any of the symptoms of "white finger syndrome" occur, seek immediate medical attention. Symptoms of the "white finger" include numbness, loss of sensitivity, tingling, tingling, and

pain, loss of strength, color changes or skin condition. These symptoms usually appear on the fingers, hands or wrists. Risk increases at low temperatures.

Intended use

- This 4 in 1 petrol multi-tool is designated with an engine displacement of 33cm³. Depending on the attached accessory this product is intended to be used as:
 - a). Brush Cutter: With the cutter blade attached the product is intended to cut heavier weeds, brush and similar vegetation.
 - b). Grass trimmer: With the line spool attached the product is intended to cut smaller types of weed, lawn grass or similar soft vegetation. It must not be used to work on unusually thick, dry or wet grass, e.g. pasture grass, or to shred leaves.
 - c). Pole hedge trimmer: With the hedge trimmer blade attached the product is intended for trimming wide and high hedges, bushes and shrubs.
 - d). Pruner: With the saw chain/guide bar assembly attached the product is intended for cutting limbs with a thickness of max. 180 mm. The product may only be used with the guide bar/saw chain combination stated in these instructions. It is not permitted to use other types or sizes.
- The product must not be used for cutting other materials, such as plastic, stone, metal or wood that contains foreign objects and must not be used outside of domestic premises.
- Observe the technical data for the maximum cutting capacity according to the application (see “Technical Data”). Do not cut plants exceeding the stated maximum capacity.
- This product is intended for private domestic use only, not for any commercial trade use. It must not be used for any purposes other than those described.

COMPONENT LIST

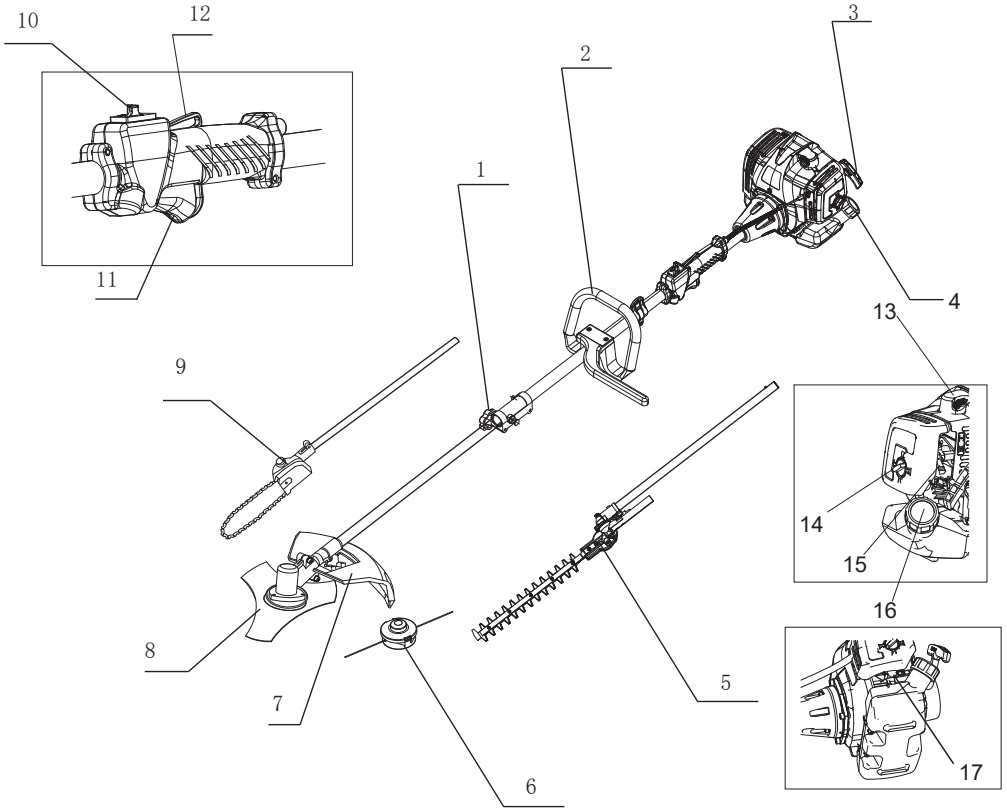

- | | |
|------------------------|------------------------|
| 1. Knob | 10. Switch |
| 2. Handle | 11. Throttle Interlock |
| 3. Starter | 12. Throttle lever |
| 4. Fuel cap | 13. Magneto stator |
| 5. Hedge trimmer shaft | 14. Air filter knob |
| 6. Spool | 15. Chock lever |
| 7. Guard | 16. Fuel cap |
| 8. Blade | 17. Primer bulb |
| 9. Chain saw shaft | |

Not all the accessories illustrated or described are included in standard delivery.

ASSEMBLY AND USE

1. Unpack

- a. Unpack all parts and lay them on a flat, stable surface.
- b. Remove all packing materials and shipping devices if applicable. Make sure the delivery contents are complete and free of any damage. If you find that parts are missing or show damage do not use the product but contact your dealer. Using an incomplete or damaged product represents a hazard to people and property.
- c. Ensure that you have all the accessories and tools needed for assembly and operation. This also includes proper personal protective equipment.
- d. Disconnect the spark plug connector from the spark plug.



WARNING! Be careful with small parts that are removed during assembly or when making adjustments. Make sure you do not lose them.

2. Assembly

a. AUXILIARY HANDLE ASSEMBLY

- 1) Loosen the outer pre-assembled screws on the auxiliary handle.
- 2) Align the step guard with the screw to one of the holes in the shaft and insert the shorter screw into the hole. Tighten it with the cross head screwdriver.
- 3) Place the handle onto the shaft from the top and secure it with the longer screws. Tighten them with the hex key.

NOTE: There are holes on the bottom side of the upper shaft above the clamp to adjust the position of the handle.

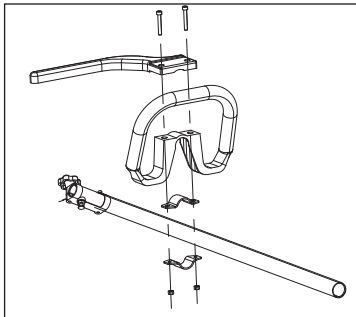

b. Adjusting The Handle

- 1) Loosen the bolts on the auxiliary handle and adjust the position.
- 2) Afterward tighten the bolts.

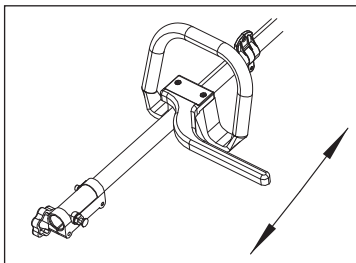

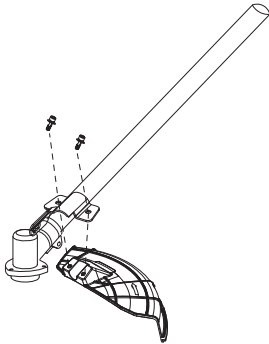

c. Brush cutter/grass trimmer guard assembly

Note. The safety guard for the brush cutter and grass trimmer comes in two separate parts, to be adapted dependent on purpose.

1. Remove the two screws from the guard.
2. Align the screw hole in the mounting bracket with the screw hole in the grass guard.
3. Insert the screws through the mounting bracket and into the grass guard.
4. Tighten the screw securely.

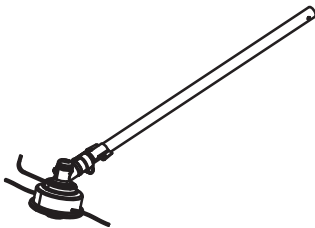

d. Brush cutter blade or string head assembly

1. Align the slot in the flanged washer with the slot in the gear head.
2. Place the hex wrench through the slot in the flanged washer and gear head.
3. Remove the string head assembly.
4. Remove the cupped washer and flanged washer, and then retain it for the blade installation.
5. Place the flanged washer over the gear head shaft with the hollow side toward the gear head.
6. Center the blade on the flanged washer, making sure the blade fits flat and the raised hub of the flanged washer goes through the hole in the blade.
7. Install the cupped washer with the raised center away from the blade.
8. Place the blade nut onto the gear head shaft.
9. Place the hex wrench through the slot in the flanged washer and gear head.
10. Install the blade nut by turning it counterclockwise (left handed threads).
11. Tighten the blade nut securely

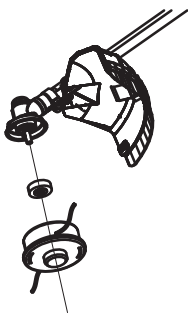

NOTE! if change from brush cutter to grass trimmer, operate in reverse order.

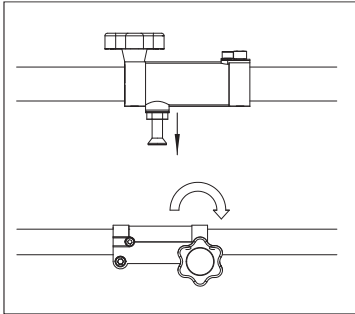

e. Two-piece shaft assembly

- 1) Align the lower shaft with the clamp so that the hole in the extension is orientated to the locking pin.
- 2) Pull out the locking pin and insert the lower shaft into the clamp . Release the locking pin and ensure it engages in the hole.
- 3) Secure the connection by tightening the locking knob clockwise

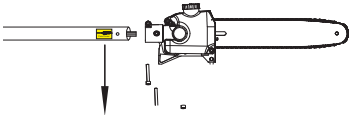

f. Pole pruner assembly

- 1) Loosen the two bolts on the joint and then align the hole of the pole pruner shaft. Instructed by warning sticker.
- 2) Insert the shaft and secure the connection with the bolts by using the hex key.

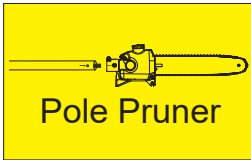

Assembly instruction sticker

g. Saw chain tensioning

Always check the saw chain tension before use, after first cuts and regularly during use, approx. every five cuts. After initial operation, new chains can lengthen considerably. This is normal during the break-in period and the interval between future adjustments will lengthen quickly.



WARNING! Always switch the product off and disconnect the spark plug connector before adjusting the saw chain tension! The cutting edges of the saw chain are sharp. Always wear protective gloves when handling the chain! Always maintain proper chain tension! A loose chain increases the risk of kickback! A loose chain may jump out of the guide bar groove! This may injure the operator and damage the chain! A loose chain will cause rapid wear to the chain, guide bar and sprocket!

Tensioning the chain too tightly will overload the engine and cause damage, and insufficient tension can cause chain derailing, whereas a correctly tightened chain provides the best

cutting characteristics and prolonged working life! The chain life mainly depends upon sufficient lubrication and correct tensioning!

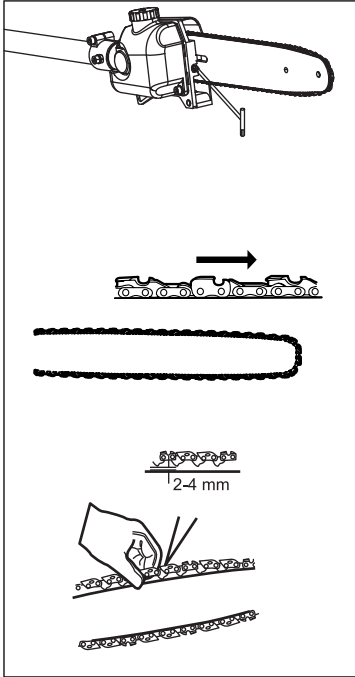

- 1) Loosen the locking nut. Lift the tip of the guide bar and keep it there as you adjust the tension.
- 2) Turn the tension screw clockwise until the chain "tie straps" are just touching the bottom edge of the guide bar.
- 3) Check the chain tension using one hand to lift the saw chain against the weight of the product. The correct chain tension is achieved when the saw chain can be lifted by approx. 2-4mm from the guide bar in the centre.
- 4) Turn the locking nut to tighten the cover completely.

h. Chain lubrication



WARNING! The product is not filled with chain oil. It is essential to fill the product with chain oil before using it! Never operate the product without chain oil as this will result in extensive damage to the product!!

Operating the saw chain dry or with too little chain oil will decrease cutting efficiency, shorten the product life span and cause rapid wear to the saw chain and guide bar from overheating! Insufficient chain oil is evident by smoke or bar discoloration!

Adequate lubrication of the saw chain during cutting operations is essential to minimise friction with the guide bar!

- 1) Set the product on any suitable surface with the chain oil tank cap facing upwards.
- 2) Unscrew and remove the tank cap, then add the lubricant into the tank. We recommend using environmentally-

friendly chain oil specifically intended to be used with this product.

3) Use a proper funnel with a filter to prevent debris entering the tank and to avoid spilling and overfilling the tank. Do not overfill and leave approximately 5 mm of space to the lower edge to allow the lubricant to expand.

4) Wipe up spilled fuel with a soft cloth and refit the chain oil tank cap.

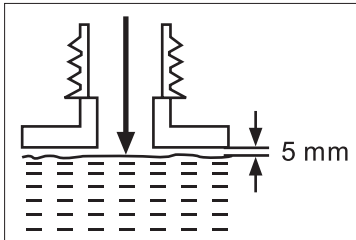

NOTE: Always dispose of lubricant, used oil and objects contaminated with them in accordance with local regulations.

5) Check the chain lubrication before each use.

Note: This product is equipped with an automatic oiling system! The oiling system automatically delivers the proper amount of oil to the bar and chain! Checking the lubrication requires starting the engine. Before checking the product must be fully assembled and all instructions must have been read.

- Make sure the guide bar and the saw chain are in place when you check the oil delivery.
- Start the engine; keep it running at medium power and check if the chain oil is delivered as shown in the figure.

i. Attachments

- Assemble the relevant attachment to suit the intended application.



WARNING! Read all the instructions carefully! Do not start the product until it is completely assembled! Always wear gloves during assembly!

NOTE: This product can be used with different cutting heads for different applications. Follow the assembly steps for respective application.

m. Harness



WARNING! Always attach the product to the harness.



1) Adjust the length of the harness so that the hook is approximately 15 cm below your waist; locate the product to the harness by using the securing clip ensuring that the angle of the cutting head is parallel to the surface being cut.

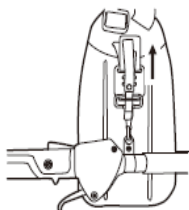

2) In case of emergency, pull the rope of the quick release mechanism. The metal locking bar will be released from the securing clip automatically because of the weight of the machine, and the machine will drop away from you.

3. Operation

a. Fuel and engine oil

This product is equipped with a 2-stroke engine, the fuel and oil tank are combined and it is essential to fill a fuel-oil mixture before operating this product. Observe the technical specifications for suitable fuel and engine oil.



WARNING! This product is not supplied with fuel-oil mixture in the engine! Before operating this product it is essential to fill it with fuel!



WARNING! Fuel and oil are highly inflammable! Fumes will explode if lit! Ensure that there are no naked flames around the product! Do not smoke while filling fuel and oil!

- 1) Place the product on a stable, level surface. We recommend laying a non-flammable sheet under the product.
- 2) Mix a regular-grade unleaded petrol and a quality engine oil for air cooled 2 stroke engines in a suitable container.
- 3) Use an anti-oxidant added quality oil expressly labelled for air-cooled 2 stroke engine use (JASO FC GRADE OIL or ISO EGC GRADE). Do not use BIA or TWC (2 stroke water cooling type) mixed oil.

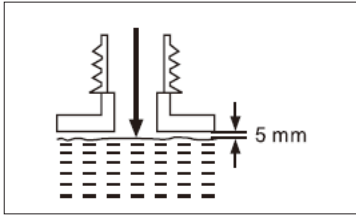
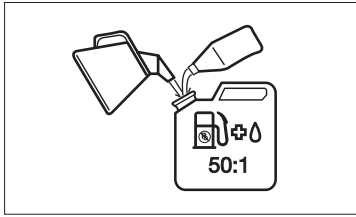

- 4) The recommended mixing ratio for petrol : oil is 50:1.
- 5) Unscrew and remove the fuel tank cap.
- 6) Fill correctly mixed fuel/oil into the tank using a fuel funnel (NO SUPPLIED) fitted with a filter to avoid debris entering the tank. Do not overfill. Leave a minimum 5 mm of space between the top of the fuel and the inside edge of the tank to allow for expansion.
- 7) Avoid spilling and overfilling the tank. Wipe up spilled fuel with a soft cloth and refit the fuel tank cap.
- 8) Always dispose of fuel, used oil and soiled objects according to local regulations (see section "ENVIRONMENTAL INFORMATION").

NOTE: Fuel and oil deteriorate over time. It may be difficult to start the engine if you use fuel which has been kept for more than 30 days. Towards the end of the season, it is advisable to put only as much fuel in the tank as you need for each mowing of the lawn, since it should be completely used up before storing the product. Empty remaining fuel from the tank when storing the product for over 30 days.

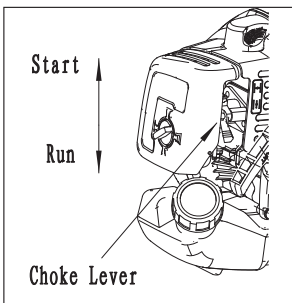
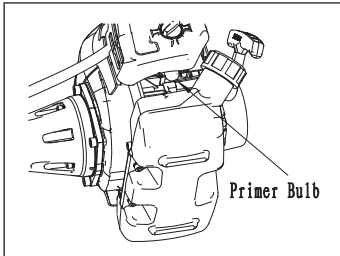

b. Starting instructions

1. Cold start

- Place the product on a flat, stable surface. Ensure that the attachment in use does not touch the ground or any objects.
- Set the ignition switch to its on position "I".
- Press the primer 5-6 times until the fuel is visible. Move the choke lever to the start position.
- Hold the product stable and pull the recoil starter handle firmly; repeat until the engine starts. Allow the recoil starter rope to return slowly and controlled after each pull!
- Allow the product to run at idle speed for 10 to 15 seconds to let it warm up; move the choke lever to its " " position once the engine is warm.
- Once the engine is running correctly, carefully lift the product and securely hold it by its handles

NOTE: During idle running the cutting blade should not move. Contact a qualified technician if you find that the cutting blade is moving.

2. Warm start

Place the product on a flat, stable surface. Ensure that the attachment in use does not touch the ground or any objects. Set the ignition switch to its on position "I".

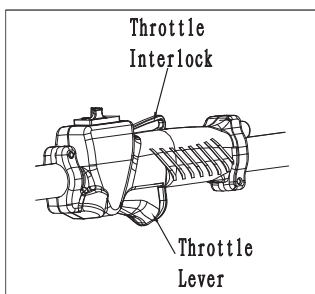
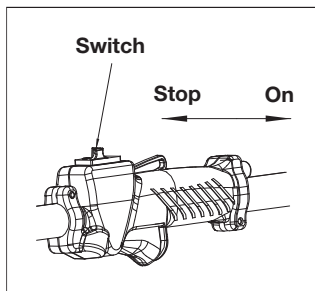

Move the choke lever to the “ ” position, do not press the primer.

Hold the product stable and pull the recoil starter handle firmly; repeat until the engine starts. Allow the recoil starter rope to return slowly and controlled after each pull!



WARNING! Make sure that the cutting blade is not touching the ground or other objects when starting the product!

3. Control

- Press the throttle interlock, hold it in position and then press the throttle trigger to engage the attachment.
- Release the throttle trigger, this tool will be set at idle speed status.

4. Stopping

- Release the throttle trigger and let the product run at idle speed for 10-15 seconds.
- Set the ignition switch to its off position "STOP".



WARNING! The attachment will continue to move for some time even after the engine has been switched off! Wait until the attachment has come to a complete stop before placing the product on the ground!

5. general behaviour

- Check the product as well as accessories for damage before each use. Do not use the product if it is damaged or shows wear.
- Double check that accessories, safety guards and blades are properly fixed.
- Always hold the product the product by its handles. Keep the handles dry to ensure safe support.
- Ensure that the air vents are always unobstructed and clean. Clean them if necessary with a soft brush. Blocked air vents may lead to overheating and damage the product.
- Switch the product off immediately if you are disturbed while working with it and when other people enter the working area. Always let the product come to complete stop before putting it down.
- Do not overwork yourself. Take regular breaks to ensure you can concentrate on the work and have full control over the product.

6. Brush Cutter



WARNING! To avoid hazards never cut heavier weeds, brush and similar vegetation with a thickness of over 20mm. Avoid contact with stones, wire, glass etc. that may cause injury to the user! Inspect the blade regularly for damage, cracks or breaks! Always replace a damaged blade!



WARNING! When working with the cutter blade there is always a risk of kickback if the cutting head comes into contact with a hard object! Kickback will cause the sudden stalling of the cutting head, which in turn results in the cutting head being forced in the opposite direction to the rotation of the cutter blade! Ensure that you retain a firm grip with both hands at any sign of such kickback, pay attention and retain a firm stance to avoid injuries!

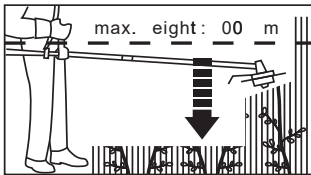

- Use the cutter blade to cut heavier weeds, brush and similar vegetation with a thickness of up to 20mm.
- Hold the product firmly so that it sits with a gap between the product and your right side.
- Stand upright, do not lean forward and pay attention to posture. Keep both feet apart to help retain your balance.
- Never hold the cutting head higher than your hip; the higher you hold the cutting head will increase the risk of objects being thrown.
- Carefully plunge the blade from above when cutting long undergrowth.
- Move the cutting head towards the base of young trees or thicker vegetation.

7. Grass Trimmer

- Use the trimmer head to cut smaller types of weed, lawn grass or similar soft vegetation.
- Remove the protection cap from the line cutter.
- Hold the product firmly so that it sits with a gap between the product and your right side.
- Stand upright, do not lean forward and pay attention to posture. Keep both feet apart to help retain your balance.
- Hold the trimmer head just above the ground at an angle of approximately 30°.

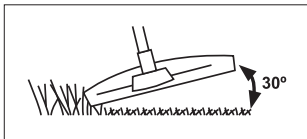

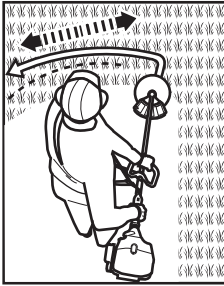

- Move the product with slow and regular arc from left to right before moving it back to the starting position before trimming the next area.

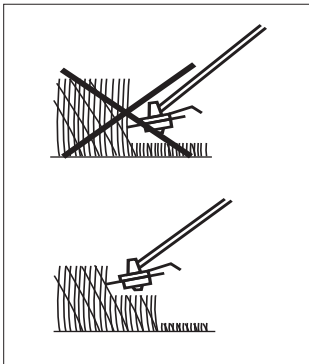

- Ensure the cutting head remains clean and free from off-cuts that may cause it to jam. Check regularly. Stop the engine, switch the ignition switch to “STOP” and remove the spark plug connector before checking.
- Trim longer grass in stages, do not cut long grass in one cut. For the best results, cut longer grass in steps.

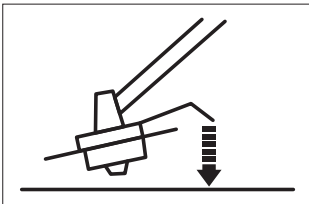

- The trimmer head is equipped with a bumper helping to cut the trimming line while operating. Simply tap the bumper on a firm surface and the spool will release fresh trimming line.

- A line cutter is integrated with the trimming guard and this will cut the line to the necessary length.



**WARNING! The cut line will be thrown out!
Danger of injury especially for bystanders!**

- For best results, do not cut wet grass because it tends to stick to the cutting heads and guard, prevents proper discharge of grass trimmings, and could cause you to slip and fall.

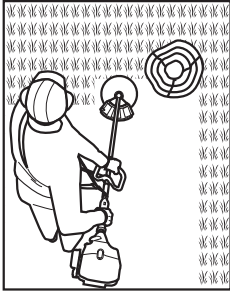

- Pay special attention when performing the work close to trees and bushes. The cutting heads could damage sensitive bark, and damage fence posts.

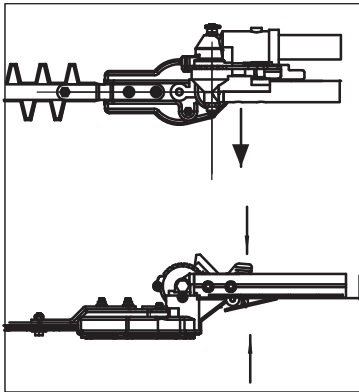

8. Hedge trimmer angel adjustment

- Pull the locking pin out.
- Depress the unlock levers with one hand and hold them in position.

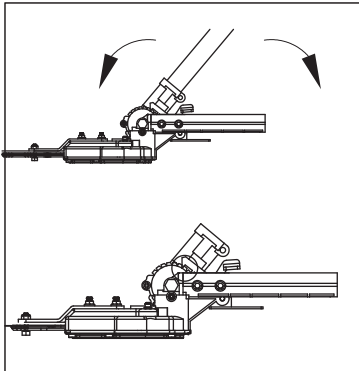

Move the hedge trimmer shaft with the other hand until the desired angle is adjusted.

Release the unlock levers when the desired angle is adjusted. Ensure that the hook engages between two teeth of the tooth wheel.

- Make sure the unlock pin engages automatically and the joint is secured.



9. Hedge trimming

- Prepare the product to required length attaching the pole extensions and/or the hedge trimmer shaft.
- Cut and remove branches exceeding the cutting capacity of this product using a proper pruner before operation.
- Always hold the product firmly with both hands on gripping surface and handle grip. Never operate this product using only one hand.
- Cut both sides from the bottom cutting upwards to the top. This will prevent any of the cuttings falling into the path of the area still to be cut.



- After cutting the sides proceed to the top.
- When cutting wide hedges with the cutting area in sight move the cutting blade lightly through the cutting surface in a sweeping motion following the shape of the hedge or shrub.
- A slight tilt downwards of the cutting blade in the direction of motion is recommended for optimum cutting performance.



- Move the product with slow motion forward when cutting higher hedge and the cutting area out of sight

- Do not to rush and do not attempt to cut too much with one stroke of the cutting blade.

NOTE: Try to keep the cutting blade angled at approximately 15° to the cutting surface.

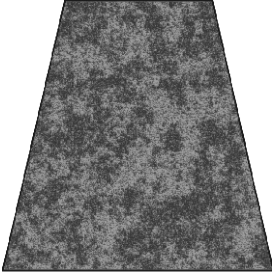

- Cut in a number of stages if the area being cut is particularly long to achieve a better result; smaller cuttings will allow for easy composting.

NOTE: When shaping it is advisable to achieve a trapezoidal shape. A trapezoidal cut corresponds to the natural growth of plants and results in optimal hedge growth, as it will expose more light to the bottom of the hedge.

10. Pruner

Kickback



WARNING! Beware of kickback! Kickback can lead to dangerous loss of control of the product and result in serious or fatal injury to the operator or anyone standing close by! Always be alert because rotational kickback and pinch kickback are major product operational dangers and the leading cause of most accidents!

- Kickback is the sudden backward/upward motion of the product, occurring when the chain (at the tip of the chain bar) comes in contact with a log or wood, or when the chain becomes jammed.
- When kickback occurs the product reacts unpredictably and can cause severe injuries to the operator or bystanders.
- With a basic understanding of 'kickback', the element of surprise can be reduced or eliminated. Sudden surprise contributes to the majority of accidents.
- You should read all the safety warnings and user instructions carefully before attempting to operate this product.

To avoid kickback:

- Never work with a loose, overstretched or worn out chain
- Ensure chain is sharpened correctly
- Never work with the tip of the guide bar
- Always hold the tool firmly with both hands
- Always use a low kickback chain
- Ensure correct chain tension

11. Pruning

Always hold the product firmly with both hands on gripping surface and handle grip. Never operate this product using only one hand.

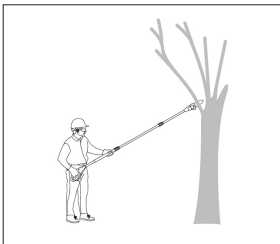

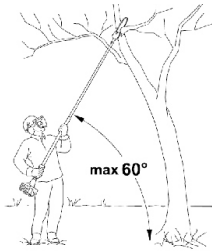

- Maintain a firm grip with your thumbs and fingers encircling the handles. A firm grip will help you reduce 'kickback' and maintain control of the product.
- Always hold the product at an angle of not more than 60° from the horizontal level. Otherwise safe operation is not possible.

- Never stand directly under the limb you are sawing. Objects may fall different than expected. Always position yourself out of the path of falling limbs.
- Keep other persons away from cutting end of product and at a safe distance from the work area. Maintain a minimum distance of 10m to bystanders.



WARNING! Never climb into a tree to prune! Do not stand on ladders, platforms, logs, or in any position which may cause you to lose your balance or control of the product! When pruning trees, it is important not to make the flush cut next to main limb or trunk until you have cut off the limb further out to reduce the weight! This prevents stripping the bark from the main member!

- Never stand on a ladder or other type of unstable support while using the product. Insecure stand invites hazards.



WARNING! This product has not been designed to provide protection from electric shock in the event of contact with overhead electric lines! Therefore do not use product near cable, electric power or telephone lines. Keep a minimum distance of 10 m to all electric lines.

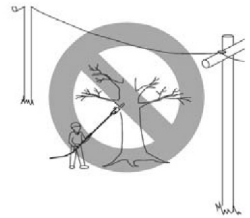

- Use the product only with secure footing. Hold the product at the right-hand side of your body.
- Do not operate the product with arms fully extended or attempt to cut areas which are difficult to reach.
- Keep a firm, steady pressure on the product while working

with it. Do not try to force the product through the wood, let the cutting device do the work, using the gripping teeth to apply minimal leverage pressure.

- Beware when reaching the end of the cut. The weight of the product may change unexpectedly as it cuts free from the wood. Accidents can occur to the legs and feet. Always remove the product from a wood cut while it is running.

NOTE: The chain must be running at full speed before it comes into contact with the wood.

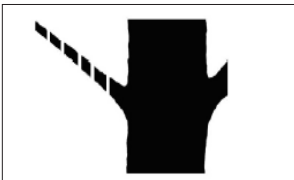

- Cutting Thin Branches

Thin branches can be cut off with one single cut. To prevent the branch from splintering and buckling the branch should be cut off in several pieces.

- Cutting Thick Branches

When cutting larger branches, three cuts are necessary as shown below:

NOTE: Remove the branches lying on the floor regularly to avoid stumbling hazards. Check the oil level regularly and fill up if necessary. Switch the power off and disconnect from power source when leaving the product.

- First cut into the branch from below, outside of the location where you intend to cut off the branch. The cut should go one third to halfway through the branch.
- Cut into the branch from the top, outside from where the branch is to be sawn.
- Last, cut off the stump with one clean cut from top to bottom. You might want to seal the cut with a suitable compound.
- You might want to seal the cut with a suitable compound.



NOTE: Remove the branches lying on the floor regularly to avoid stumbling hazards. Check the oil level regularly and fill up if necessary. Switch the power off and disconnect from power source when leaving the product.

12. After Use

- Switch the product off, allow the engine to cool down and then remove the spark plug connector.
- Check, clean and store the product as described below.

Care and Cleaning



WARNING! Always switch the product off, let the product cool down and disconnect the spark plug connector before performing inspection, maintenance and cleaning work!



WARNING! Only perform repairs and maintenance work according to these instructions! All further works must be performed by a qualified specialist!



WARNING! Wear safety gloves when working on the attachment heads and close to it! Use appropriate tools to remove debris, e.g. a brush or wooden stick! Never use your bare hands! Keep the product clean. Remove debris from it after each use and before storage. Regular and proper cleaning will help ensure safe use and prolong the life of the product. Inspect the product before each use for worn and damaged parts. Do not operate it if you find broken and worn parts.

a. General cleaning

NOTE: Do not use chemical, alkaline, abrasive or other aggressive detergents or disinfectants to clean this product as they might be harmful to its surfaces.

- 1) Clean the product with a slightly damp cloth and mild soap. Use a brush for areas that are hard to reach.
- 2) In particular clean the air vents after every use with a cloth and brush.
- 3) Remove stubborn dirt with high pressure air (max. 3 bar).
- 4) Check for worn or damaged parts. Replace worn parts as necessary or contact an authorised service centre for repair before using the product again.

b. Blade (Brush Cutter)

- 1) Keep the cutting blade (B5) clean and free of debris. Remove clippings.
- 2) Keep the cutting blade (B5) sharp to retain a good cutting performance. Replace a worn or damaged cutting blade with a new one of the same type.

c. Trimmer Head

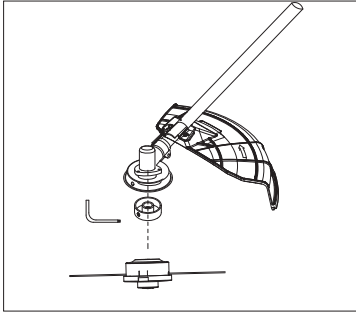

- 1) Keep the trimmer head clean and free of debris. Remove trimmings.
- 2) If the line is used up the spool must either be replaced by one of the same type or the trimming line must be refilled.
- 3) To refill the trimming line lay the product on a flat stable surface with its trimmer head facing upwards.
- 4) Rotate the backing flange until one of the notches is aligned with the hole in the gear head.
- 5) Insert the spindle lock rod into the hole to lock the spindle.
- 6) Remove the trimmer head by unscrewing clockwise.
- 7) To replace the spool simply remove from the trimmer head and replace with a new one of the same type.

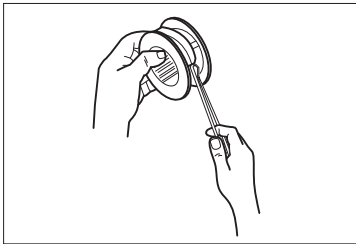
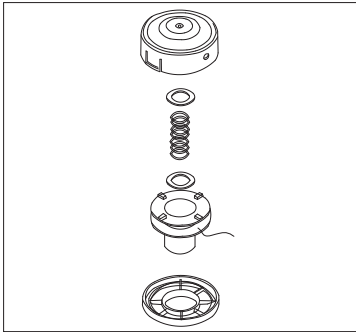

- 8) To replace the trimming line, press the release latch of the trimmer head housing to open the cover.
- 9) Cut a new 6 m long trimming line with a diameter of 2 mm. Form a loop at the middle of the line and insert this loop into the hook on the spool.

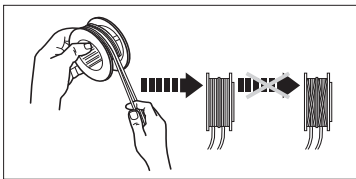

- 10) Wind the two parts of the trimming line in clockwise direction firmly around the spool each part in the guide on the spool.

- 11) Insert each end of the threads in the respective holes. The threads should stick out 150 mm on each side.

- 12) Screw the bumper anti-clockwise until it is completely and safely locked.
- 13) Remove the spindle lock rod.



WARNING! After changing the trimming line, run the product under no load for at least a minute to make sure that the line and the product are operating correctly!



WARNING! Never use steel thread! Always use cutting means in perfect condition, free of damage!

d. Blade (Hedge Trimmer)

- 1) Keep the hedging blade clean and free of debris. Remove trimmings.
- 2) Keep the hedging blade sharp to retain a good cutting performance. Replace a worn or damaged cutting blade with a new one of the same type.
- 3) Lubricate the hedging blade after each use to prolong the life span of cutting blade and product. Apply light machine oil along the edge of the cutting blade.

e. Blade (hedge trimmer)

- 1) Keep the hedging blade clean and free of debris. Remove trimmings.
- 2) Keep the hedging blade sharp to retain a good cutting performance. Replace a worn or damaged cutting blade with a new one of the same type.
- 3) Lubricate the hedging blade after each use to prolong the life span of cutting blade and product. Apply light machine oil along the edge of the cutting blade.

f. Replace chain and guide bar

- 1) Use only the guide bar and saw chain according to the technical data of the product.



WARNING! Always use a saw chain designed as “low-kickback” or a saw chain which meets the low-kickback requirements! A standard saw chain (a chain which does not have the kickback reducing guard links) should only be used by an experienced professional operator! Nevertheless, a low-kickback saw chain does not completely eliminated kickback! A low-kickback or “safety” chain should never be regarded as complete protection against injury!

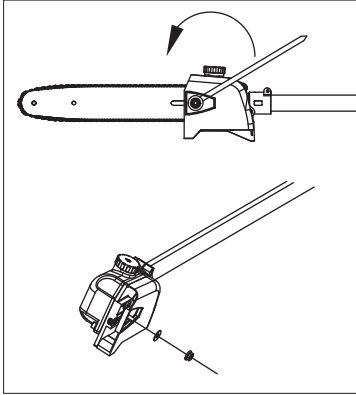

- 2) Place the product on a suitable flat surface with the cover facing upwards.
- 3) Loosen locking nut with the socket wrench anticlockwise and remove it together with the spring washer and cover.

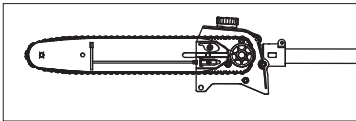

- 4) Turn the tension screw clockwise with the slotted screw driver and make sure the tension pin is adjusted to its closer position.

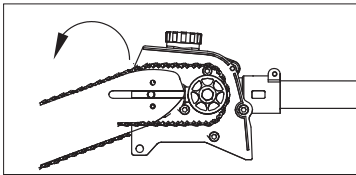

- 5) Take off the guide bar and chain.

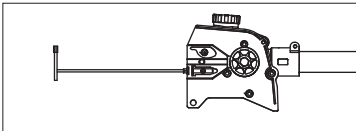

- 6) Ensure that the tension pin is adjusted to its far right position before assembly the checked or the new chain and guide bar. If not, turn the tension screw anticlockwise with the slotted screwdriver.

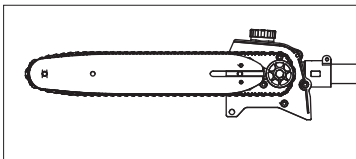

- 7) Spread the saw chain around the guide bar. Slide the chain into the groove around the guide bar. Pay attention to the cutting direction.
- 8) Align the saw chain around the drive sprocket and place one corner of the guide bar into a gap of the sprocket.
- 9) Make sure the tension pin is inserted into the lower hole on the guide bar.

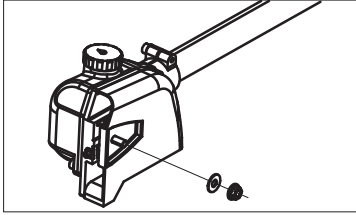

10) Put it together with the spring washer and cover ,and tighten locking nut with the socket wrench clockwise .

NOTE: The saw chain has not yet been tensioned. Tension the chain as described under “Saw chain tensioning”.
After operating the product for approx. 30min, adjust the chain.

g. Guide bar

Most guide bar problems can be prevented merely by keeping the product well maintained. Incorrect filling and non-standard cutter and depth gauge settings are the causes of most guide bar problems, primarily resulting in uneven bar wear. As the bar wears unevenly, the rails widen, which may cause the chain to clatter and make it difficult to complete straight cuts. If the guide bar is insufficiently lubricated and the product is operated with a saw chain which is too tight, this will contribute to rapid bar wear. To help minimise bar wear, maintenance of the guide bar as well as the saw chain is recommended.

1) Disassemble the guide bar and saw chain in reversed order from assembly.

2) Check the oiling port for clogging and clean if necessary to ensure proper lubrication of the guide bar and saw chain during operation. Use a soft wire small enough to insert into the oil discharge hole.

3) Check the drive sprocket. If it is worn or damaged due to strain, have it replaced by an authorised service agent.

4) Clear residue from the rails on the guide bar using a screwdriver, putty knife, wire brush or other similar tool. This will keep the oil passages open to provide proper lubrication to the guide bar and saw chain.

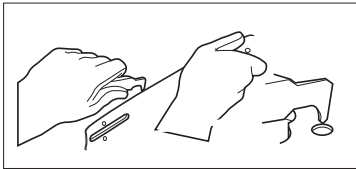

5) Check the guide bar 'rail' for wear: Hold a ruler (straight edge) against the side of the guide bar and 'cutter side plates'. If there is a gap between the ruler and guide bar the guide bar 'rail' is normal. If there is no gap (ruler flush against the side of the guide bar) the guide bar 'rail' is worn and needs to be replaced with a new one of the same type.

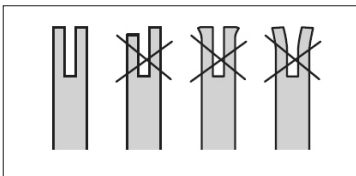

6) Turn the guide bar 180° to allow even wear, thereby extending the life span of the guide bar.

7) Check the saw chain for possible wear and damages. Replace it with a new one if required. Experienced user can sharpen a dull saw chain (see section “Saw chain sharpening” below).

8) Refit the saw chain and the guide bar as described under “Assembly”.

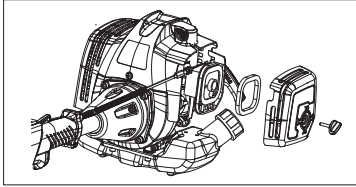

h. Air filter

1) Inspect the air filter regularly. Replace it with a new one if necessary.

2) Open the air filter case with the cross-head screwdriver, and remove the filter.

3) Tap the filter on a stable surface to remove dust. Use compressed air (max. 3 bar) to remove stubborn dust.

4) Apply a small amount of air filter oil on the filter to increase the performance of the filter.

5) Wring out surplus oil and put the filter into the case.

6) Close the air filter cover.

i. Fuel tank

1) Empty the fuel tank when storing the product over 30 days to prevent the fuel from deteriorating.

2) Unscrew and remove the fuel tank cap and use a proper fuel pump to empty the fuel into a suitable container.

j. Fuel filter

The fuel tank of this product is fitted with a filter located at the free end of the fuel pipe. Ask an authorised service centre or similar qualified person to check and where necessary replace it at regular intervals.

k. Spark plug

NOTE! This engine uses a RCJ6Y spark plug with 0.6-0.7mm electrode gaps. Use a suitable replacement and replace once a year.

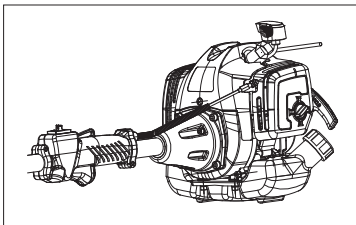

1) Inspect the spark plug at least every 25 hours or prior to long-term storage over 30 days if the use has not been this high. Clean or replace with a new spark plug if necessary.

2) Unplug the spark plug connector. Loosen the spark plug with the spark plug wrench anticlockwise and carefully remove it.

3) Check the spark plug for damage and wear. The colour of the electrode should be light brown coloured.

4) Remove debris from the electrode with a soft wired brush; avoid heavy cleaning of the electrode.

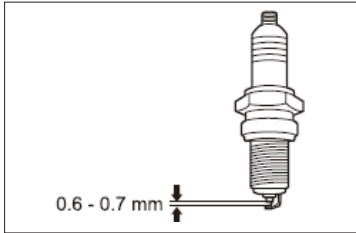

- 5) Dry the spark plug with a soft cloth if it is wet from fuel.
- 6) Check the spark plug gap; it should be 0.6 - 0.7 mm.

- 7) Replace with a new spark plug if either the electrode or the insulation is damaged
- 8) When replacing the spark plug, first screw it in hand tight and then lightly tighten it with the spark plug wrench.



WARNING! Do not over-tighten the spark plug to avoid any damage!

i. Bevel gear

The bevel gear is filled with grease. Ask an authorised service centre or similar qualified person to check the quantity regularly and fill up using proper grease if necessary.

m. Carburettor

The carburettor is pre-set by the manufacturer. Should it be necessary to make any changes please contact an authorised service centre or a similarly qualified person. Do not attempt to make any adjustments by yourself.

n. Repair

This product does not contain any parts that can be repaired by the consumer. Contact a qualified specialist to have it checked and repaired.

o. Storage

- 1) Clean the product as described above.
- 2) Store the product and its accessories in a dry, frost-free, well-ventilated place.
- 3) Always store the product in a place that is inaccessible to children. The ideal storage temperature is between 10 and 30°C.
- 4) We recommend using the original package for storage or covering the product with a proper cloth or enclosure to protect it against dust.

p. Transportation

- 1) Switch the product off and disconnect the spark plug connector before transporting it anywhere.
- 2) Attach transportation guards for cutting means of hedge trimmer, brush cutter and pruner.
- 3) Always carry the product by its handles.
- 4) Protect the product from any heavy impact or strong vibrations which may occur during transportation in vehicles.
- 5) Secure the product to prevent it from slipping or falling over.

q. Environmental protection

- 1) Waste products should not be disposed of with household waste. Please recycle where facilities exist. Check with your Local Authority or local store for recycling advice.
- 2) Petrol, oil, old oil, a mixture of oil and petrol and objects soiled with oil e.g. cleaning cloths do not belong in the household rubbish. Dispose of oily items in accordance with local guidelines and hand them in at recycling centres.
- 3) The product comes in a package that protects it against damages during shipping. Keep the package until you are sure that all parts have been delivered and the product is function properly. Recycle the package afterwards.



WARNING

Make sure that the engine has stopped and is cool before performing any service to the machine. Contact with moving cutting head or hot muffler may result in a personal injury.

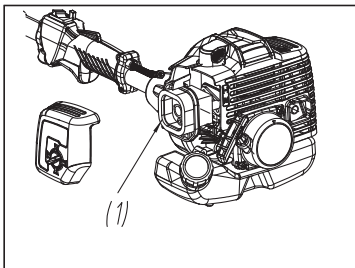

AIR FILTER

- The air filter, if clogged, will reduce the engine performance. Check and clean the filter element in warm, soapy water as required. Dry completely before installing. If the element is broken or shrunk, replace with a new one.

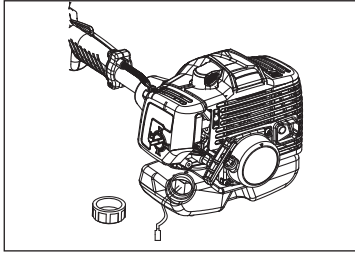

FUEL FILTER

- When the engine runs short of fuel supply, check the fuel cap and the fuel filter for blockage.

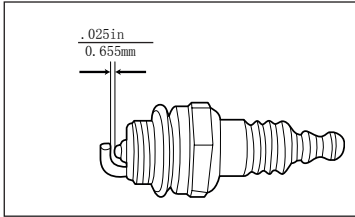

SPARK PLUG

- Starting failure and misfiring are often caused by a fouled spark plug. Clean the spark plug and check that the plug gap is in the correct range. For a replacement plug, use the correct type specified.



IMPORTANT

- **Note that using any spark plug other than those designated may result in the engine failing to operate properly or in the engine becoming overheated and damaged.**
- **To install the spark plug, first turn the plug until it is finger tight, then tighten it a quarter turn more with a socket wrench.**

TIGHTENING TORQUE: (9.8-11.8N.m.)

MUFFLER



WARNING

- Inspect periodically, the muffler for loose fasteners, any damage or corrosion. If any sign of exhaust leakage is found, stop using the machine and have it repaired immediately.
- Note that failing to do so may result in the engine catching on fire.

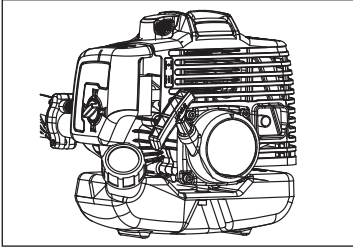

SPARK ARRESTER

- The muffler is equipped with a spark arrester to prevent red hot carbon from flying out of the exhaust outlet.
- Periodically inspect and clean as necessary with a wire brush.

INTAKE AIR COOLING VENT



WARNING

- Never touch the cylinder, muffler, or spark plugs with your bare hands immediately after stopping the engine. The engine can become very hot when in operation, and doing so could result in severe burns.
- When checking the machine to make sure that it is okay before using it, check the area around the muffler and remove any wood chips or leaves which have attached themselves to the brushcutter. Failing to do so could cause the muffler to become overheated and that in turn could cause the engine to catch on fire. Always make sure that the muffler is clean and free of wood chips, leaves, and other waste before use.
- Check the intake air cooling vent and the area around the cylinder cooling fins after every 25 hours of use for blockage, and remove any waste which has attached itself to the brushcutter. Note that it is necessary to remove the engine cover shown in order to be able to view the upper part of the cylinder.

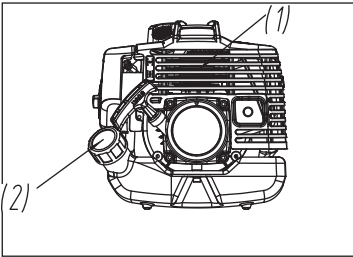

IMPORTANT

- If waste gets stuck and causes blockage around the intake air cooling vent or between the cylinder fins, it may cause the engine to overheat, and that in turn may cause mechanical failure on the part of the brushcutter.

PROCEDURES TO BE PERFORMED AFTER EVERY 100 HOURS OF USE

1. Remove the muffler, insert a screwdriver into the vent, and wipe away any carbon buildup on the muffler exhaust vent and cylinder exhaust port at the same time.
2. Tighten all screws, bolts, and fittings.
3. Check to see if any oil or grease has worked its way in between the clutch lining and drum, and if it has, wipe it away using oil-free, lead-free gasoline.

Maintenance (BC-EX only)

REFILLING TRIMMING LINE

1. For replacement line, use a diameter of 2 -2.5mm. Avoid using a larger line as it may cut down the trimming performance.



WARNING
For safety reasons, do not use metal reinforced line.

2. Pinch the slotted area on the both sides of the spool housing to unhook the bottom cap.
3. Take out the spool and pull off the old line. Put one end of new line through the spool holes and pull it until the length is equal between each part of the line.
4. Wind up the line in the correct direction as indicated on the spool.
5. Hook each end of the line, in the slot, on the edge of the spool, and then put the ends through the eyelets on the housing. Make sure that the spring and the washers are in place.
6. While holding the spool against the housing, pull the line ends to release them from the slot.
7. Line up the slot on the bottom cap with the hook on the housing; press the cap against the housing until it clicks.

GEAR CASE

- The reduction gears are lubricated by multipurpose, lithium-based grease in the gear case. Supply new grease every 25 hours of use or more often depending on the job condition.
- Remove the cutter holders before installing new grease to arrange for old grease to exit.

Maintenance (LRT-EX only)

BLADES

- When refilling the tank or resting, it is often a good idea to use the time to oil the cutting blades.
- If a gap exists between the upper and lower blades, follow the procedure below to adjust them so that they fit more closely together.

1. Loosen lock nut (A) as shown in the diagram.
2. Tighten screw (B) fully, and then turn one-third to one half of a rotation backward.
3. While holding onto the screw to keep it in position, tighten the lock nut.
4. Check to make sure that the flat washer is loose enough so that it may be turned by pressing on it with a finger.

NOTE

Screwing in the screw too tightly may make it impossible for the blades to move. Conversely, not screwing in the screw tightly enough may make the blades of the trimmer feel dull and cause leaves and branches to become caught in the blades of the trimmer.

GEAR CASE

The reduction gears are lubricated by multipurpose, lithium-based grease in the gear case. Supply new grease every 25 hours of use or more often depending on the job condition.

GUIDE BAR

Remove sawdust in the bar groove and the oiling port.(Type: Sprocket nose)

Grease the nose sprocket from the feeding port on the tip of the bar.

The bar rail should always be a square. Check for wear of the bar rail. Apply a ruler to the bar and the outside of a cutter. If a gap is observed between them, the rail is normal. Otherwise, the bar rail is worn. Such a bar needs to be corrected or replaced.

SPROCKET

Check for extensive wear, and replace it when the teeth are worn over 0.3mm

SAW CHAIN



WARNING

It is very important for smooth and safe operation to keep the cutters always sharp.

Your cutters need to be sharpened when:

- Sawdust becomes powder-like.
- You need extra force to saw in.
- The cut way does not go straight.
- Vibration increase.
- Fuel consumption increase.

Cutter setting standards:



WARNING

Be sure to wear safety gloves.

Before filling:

- Make sure the saw chain is held securely.
- Make sure the engine is stopped.
- Use a round file of proper size for your chain.

Place your file on the cutter and push straightforward. Keep the file position as illustrated. After every cutter has been set, check the depth gauge and file it to the proper level as illustrated.

- (1) Appropriate gauge checker
- (2) Make the shoulder round
- (3) Depth gauge standard



WARNING

Be sure to round off the front edge to reduce the chance of kickback or tie-starp breakage.

Make sure every cutter has the same length and edge angles as illustrated.

GEAR CASE

The reduction gears are lubricated by multipurpose, lithium-based grease in the gearcase. Supply new grease every 25 hours of use or more often depending on the job condition. When adding lubricant, use a grease gun to insert lubricant into the three grease nipples located on the gearcase.

NOTE

- **When removing and installing the cutter holder (a), use care not to allow any dirt and dust entering in to the gear case.**

Aged fuel is one of major causes of engine starting failure. Before storing the unit, empty the fuel tank and run the engine until it uses all the fuel left in the fuel line and the carburettor. Store the unit indoor taking necessary measures for rust prevention.

TROUBLE SHOOTING

Use this section to help you to try and solve any problems you may have:

Case 1. Starting failure

CHECK	PROBABLE CAUSES	ACTION
Fuel tank	Incorrect fuel	Drain it and use correct fuel
Fuel filter	Fuel filter is clogged	Clean
Carburettor adjustment screw	Out of normal range	Adjust to normal range
Sparking (no spark)	Spark plug is fouled/wet Plug gap is incorrect	Clean /dry Correct (GAP:0.6-0.7)
Spark plug	Disconnected	Retighten

Case 2. Engine starts but does not keep running/hard re-starting

CHECK	PROBABLE CAUSES	ACTION
Fuel tank	Incorrect fuel or staled fuel	Drain it and use correct fuel
Carburettor adjustment screw	Out of normal range	Adjust to normal range
Muffler, cylinder(exhaust port)	Carbon is built-up	Wipe away
Air cleaner	Clogged with dust	Wash
Cylinder fin, fan cover	Clogged with dust	Clean

NOTE: IF YOU EXPERIENCE A PROBLEM WITH YOUR PRODUCT, PLEASE DO NOT ATTEMPT TO OPEN OR REPAIR THE PRODUCT YOURSELF. DOING SO MAY VOID THE WARRANTY AND COULD CAUSE DAMAGE OR PERSONAL INJURY. IF THE PROBLEM STILL PERSISTS, PLEASE CONTACT US BY REFERRING TO THE SERVICE & SUPPORT INFORMATION ON THE FOLLOWING PAGE.

DECLARATION OF CONFORMITY / PERFORMANCE



Product Code: 62625/DGJ330H

Product Description: Hawksmoor 33cc Petrol Multi-Tool

1. Toolstation Limited, Express Park, Bristol Road, Bridgwater, Somerset TA6 4RN

This declaration of conformity is issued under the sole responsibility of Toolstation

2. Object of the declaration

The object of the declaration described above is in conformity with the relevant Community harmonization legislation:

Supply of Machinery (Safety) Regulations 2008

2006/42/EC

Electromagnetic Compatibility Regulations 2016

2014/30/EU

The Restriction of the Use of Certain Hazardous Substances in Electrical and Electronic Equipment Regulations 2012

2011/65/EU&(EU)2015/863

Noise Emission in the Environment by Equipment for use Outdoors Regulations 2001

2000/14/EC amended by 2005/88/EC:

- Conformity Assessment Procedure as per Annex V
- Max. Sound Pressure Level 97 dB(A)
- Declared Guaranteed Sound Power Level 117 dB(A)

3. References to the relevant standards used (or references to the specifications in relation to which conformity is declared:

BS EN ISO 11806-1, BS EN ISO 10517, BS EN ISO11681-1, BS EN ISO 14982

4. Additional information:

Signed for and on behalf of Toolstation Limited

ENVIRONMENTAL INFORMATION

Old products are potentially recyclable and do not, therefore, belong in your household rubbish. You are requested to assist us and our contribution to saving resources and protecting the environment by handing in this product at an equipped collection centre (if there is one available).

Petrol, oil, used oil, a mixture of oil and petrol and objects soiled with oil e. g. cleaning cloths do not belong in the household rubbish. Dispose of oil-contaminated items in accordance with the local guidelines and hand them in at recycling centres.

The product comes in a package that protects it against damage during shipping. Keep the package until you are sure that all parts have been delivered and the product is function properly. Recycle the package afterwards.

GUARANTEE

Toolstation products deliver reliable service for normal, household use in domestic settings. All Toolstation products are individually tested before leaving the factory.

If you are a consumer and you experience a problem with your Toolstation product, which is found to be defective due to faulty materials or workmanship within the Guarantee Period, this Toolstation Guarantee will cover repair or - at the discretion of Toolstation – replacement with a functionally equivalent Toolstation product.

Your product is under guarantee for 2 year from the date of purchase or the date of delivery of the product, if later.

The guarantee is subject to the following provisions:

- The guarantee does not cover accidental damage, misuse, cabinet parts, knobs, or consumable items.
- The product must be correctly installed and operated in accordance with the instructions contained in this manual.
- It must be used solely for domestic purpose.
- The guarantee will be rendered invalid if the product is re-sold or has been damaged by inexpert repair.
- Specifications are subject to change without notice.
- The manufacturer disclaims any liability for the incidental or consequential damages.
- The guarantee is in addition to, and does not diminish your statutory or legal rights.

CUSTOMER SUPPORT

www.coreservice.co.uk

Call us +44 01904 947568

Email: support@coreservice.co.uk

Made in China