



YARD FORCE®

FOR LIFE ON THE GO

SA650B

(GB) ROBOTIC MOWER **(FR) ROBOT-TONDEUSE**
Original Instructions Notice originale

(DE) MÄHROBOTER **(NL) ROBOTMAAIER**
Originalbetriebsanleitung Originele handleiding

(CZ) ROBOSEKAČKA **(PL) ROBOT KOSZĄCY**
Originální návod Oryginalna instrukcja





Read this manual carefully prior to assembling and operating the Robotic Mower. It is dangerous to operate this product without being familiar with these instructions. Keep this manual in a safe place and have it ready for future reference.

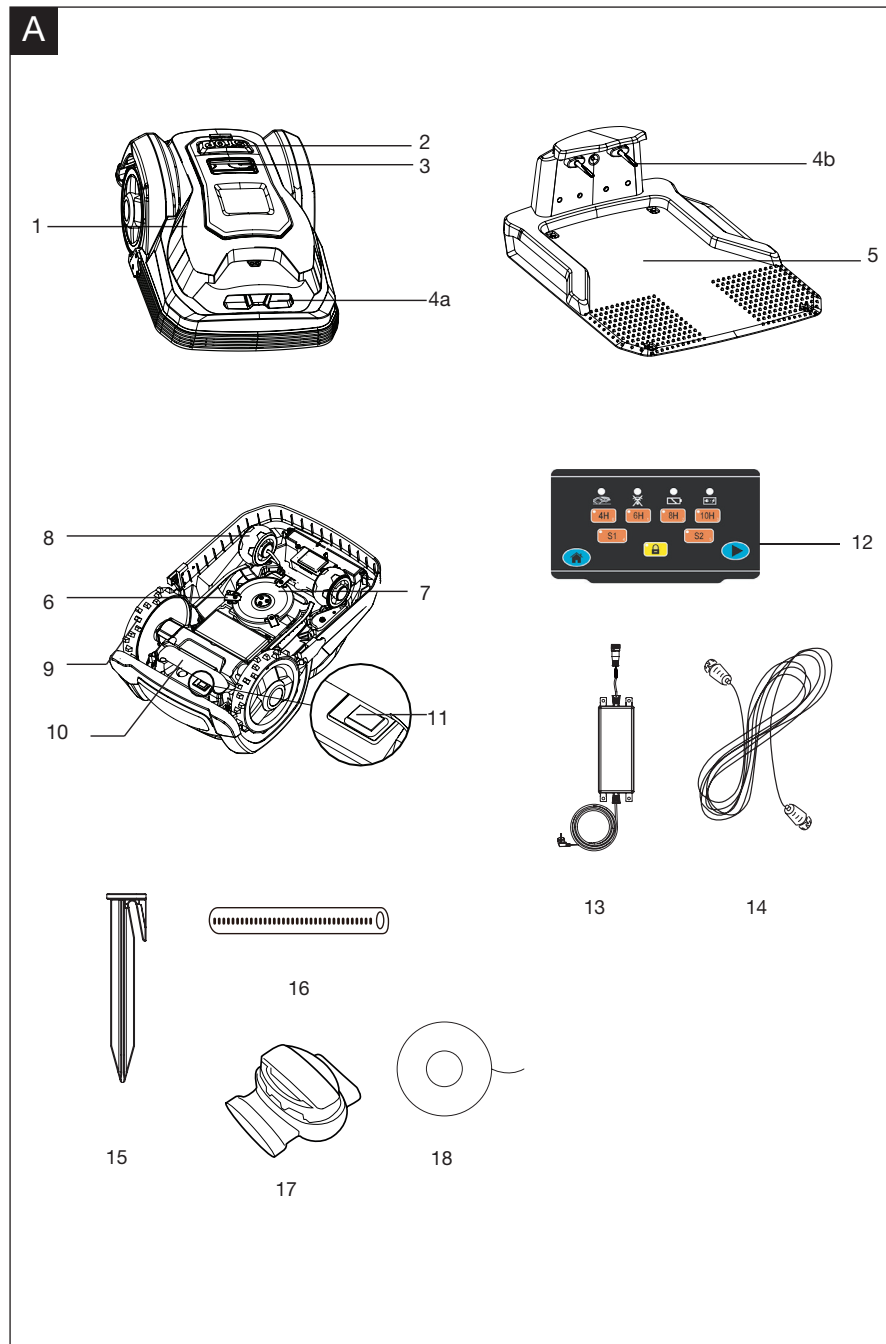

CONTENT

Introduction	05
Intended purpose	05
General description	05
Technical Data	07
Safety precautions	08
Assembly instructions	28
Operation	42
Cleaning/maintenance	48
Troubleshooting	53
Declaration of conformity	55

INTRODUCTION

Congratulations on the purchase of your new machine. During production, this device has been checked for quality and subject to a final inspection. The functionality of your equipment is therefore guaranteed. It cannot be ruled out that residual quantities of water or lubricants will remain on or in the equipment/hose lines in isolated cases. This is not a fault or defect and it represents no cause for concern.



The operating instructions constitute part of this product. They contain important information on safety, use and disposal.

Before using the product, familiarise yourself with all of the operating and safety instructions. Use the product only as described and for the applications specified. Keep this manual in a safe place and in the event that the product is passed on, hand over all documents to the third party.

The Robotic Mower is exclusively designed for mowing lawns. It is only intended for private use and is not suitable for commercial use.

INTENDED PURPOSE

Any other use that is not specifically approved in these instructions can result in damage to the Robotic Mower and could be a serious danger to the user.

This appliance **MUST NOT** be used by children and persons with reduced physical, sensory or mental capabilities or lack of experience and knowledge, unless they have been given supervision or instruction concerning use of the appliance by a person responsible for their safety.

Children should be supervised to ensure that they do not play with the appliance.

The owner or operator is responsible for accidents or harm to other people and their property.

The manufacturer cannot be held liable for damage caused by incorrect operation of the Robotic Mower or if it is not used in line with its intended purpose.

GENERAL DESCRIPTION**Scope of delivery**

Carefully unpack the mower and check that all the subsequently listed parts are present:

- Robotic Mower
- Docking station
- Switching power supply
- Extension cord
- Boundary wire
- Boundary wire connector B (blue)
- Fixing pegs
- Spare blades
- Measurement ruler (on the color box)
- Manual

GENERAL DESCRIPTION

Overview

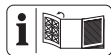





The illustration of the principal functioning parts can be found on the front and back foldout pages.

- 1 Robotic Mower x 1
- 2 STOP button
- 3 Display and keypad
- 4a: Charging contacts (Robotic Mower)
- 4b: Charging contacts (docking station)
- 5 Docking station x 1
- 6 Blade (3 of each)
- 7 Blade disc
- 8 Front wheel
- 9 Rear wheel
- 10 Carry handle
- 11 Main power switch
- 12 Control panel
- 13 Switching power supply x 1
- 14 Extension cord x 1
- 15 Fixing peg x 150
- 16 Measurement ruler (located on box) x 2
- 17 Boundary wire connector x 3
- 18 Boundary wire x 1 (120m)

Functional description

This Robotic Mower is an autonomous robot used to cut lawn grass. It will remain within an area designated by a boundary wire, start work following a programmed schedule, and return to its docking station as needed. The three sharp blades ensure clean cuts with minimal damage to the plant, leaving behind tiny snippets as natural fertilizer.

TECHNICAL DATA

Model		SA650B
Max cutting area		650 m ²
Battery		862621 / 862617 / 1990607 Lithium-Ion battery, 28 V/2.0 Ah, 56Wh
Switching power supply		FY3201500S1 / FY3201500S2 / FY3201500S3 Input 100-240V AC, 50/60 Hz Output 32 V DC, 1.5A
Typical mow time on one charge		60 min
Rated voltage		28 V DC
Rated power		50 W
No load cutting speed		3500 min ⁻¹
Cutting width		18 cm
Blade model / part number		846210
Cutting height adjustment		5 Settings
Cutting height, min-max		20 mm-60 mm
Wireless Frequency Rang/Power		2.4-2.4835 GHz/<0 dBm
Charging time		60 min
Frequency Band		0-148.5 KHz
Magnetic Field Strength		72 dBμA/m
Degree of protection:		
Robotic Mower		IP 24
Switching power supply		IP 67, PLUG IP 44
Robotic Mower weight		8.5 Kg
Docking station weight		2 Kg
Robotic Mower size, L x W x H		570 X 390 X 260 mm
Package size, L x B x H		720 X 470 X 330 mm
Gross weight		16 kg
Measured sound power level		
Measured sound pressure L _{pa}		53 dB, K=3 dB
Measured power pressure L _{wa}		64 dB, K=3 dB

* WARNING: For the purposes of recharging the battery, only use the detachable supply unit provided with this appliance.a



SAFETY PRECAUTIONS

This section covers the basic safety instructions when working with this machine.



General notes on safety

-  This machine can cause serious injury if it is not used properly. Please read these operating instructions carefully and familiarise yourself with all the control elements before operating this machine.
- Keep these operating instructions in a readily accessible place so that this information is always at your disposal.
- Please note that despite all measures to integrate safety measures into the construction, the safety devices and supplemental safety measures, a residual risk remains when using this machine.

Symbols used in the manual

-  Warning symbols with information on damage and injury prevention.
-  Warning symbol with information on the danger of electric shock.

Symbols on the machine

-  Attention!
-  These instructions must be read.

SAFETY PRECAUTIONS



Danger of injury due to flung-out material! Keep bystanders well away from the machine.



WARNING - Do not ride on the machine.
CAUTION - Do not touch rotating blade.



WARNING – Keep your hands and feet away from the rotating blades. Never place your hands or feet close to or under the body when Robotic Mower is in operation.



Return any discarded batteries to your local dealer, collector or recycle point.

It is not permitted to dispose of this product as normal household waste. Please recycle where facilities exist. Check with your local authority or retailer for recycling advice.



Class III equipment



A product placed on the United Kingdom market meets the UKCA Marking requirements

SAFETY PRECAUTIONS

Warning Symbols on the switching power supply

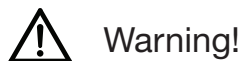

Warning!



Before use, refer to the corresponding paragraph in the manual.



Double insulation



Pole orientation



Waste electrical products should not be disposed of with household waste. Recycle where facilities exist. Check your local authority or retailer for recycling advice.



CE conformity mark



SMPS (Switch mode power supply unit) incorporating a short-circuit-proof safety isolating switching power supply



SMPS(Switch mode power supply unit)

SAFETY PRECAUTIONS

Ta:45 °C Rated maximum ambient temperature 45 °C



The charger is for indoor use only.



A product placed on the United Kingdom market meets the UKCA Marking requirements

Warning Symbols on the battery pack



Batteries contain Li-Ion and should not be disposed with general household waste. Contact your local authority for disposal advice.



Do not throw into water.



Do not throw on to fire.



Do not subject the battery to strong sunlight over long periods and do not leave it in high temperatures.(max.45 °C).



Waste electrical products should not be disposed of with household waste. Recycle where facilities exist. Check your local authority or retailer for recycling advice.

SAFETY PRECAUTIONS

Additional safety instructions for Robotic Mowers

Do not store anything heavy on the top of the Robotic Mower or docking station both during storage or when in use.

Never use the device if the main power switch (11) is damaged or does not work properly. Never modify the main power switch. Set the main power switch to OFF before storage or when the device is not in use. Use the original packaging when transporting the Robotic Mower, especially for long distances.

If you need to carry the Robotic Mower from or within the working area, first press the STOP button (2) to stop the device.

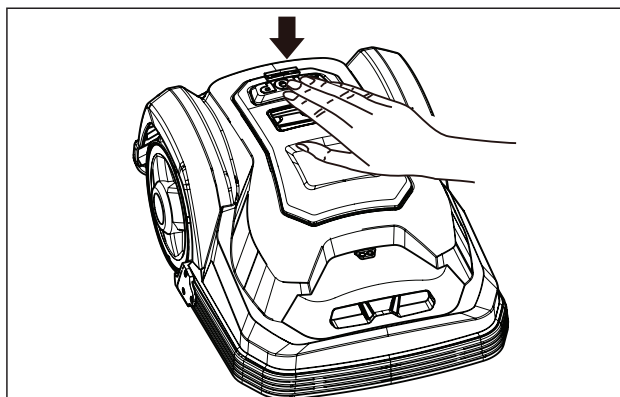

SAFETY PRECAUTIONS

Secondly, ensure that the main power switch (11) is switched OFF before you lift up the Robotic Mower.

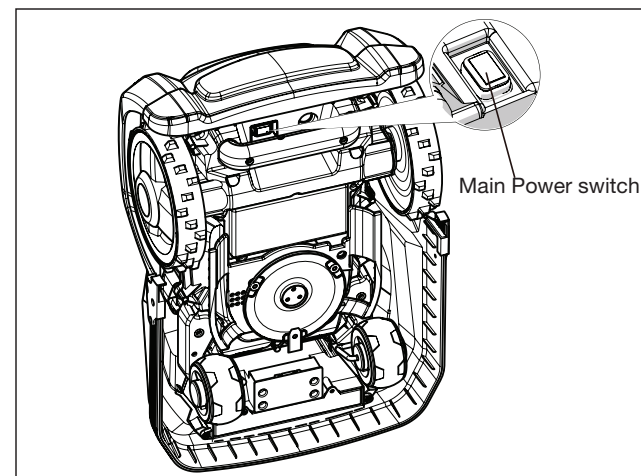

Thirdly, close the top cover, and carry the Robotic Mower using the carry handle (10) at the rear under the mower, keeping the blade disc away from your body as shown.

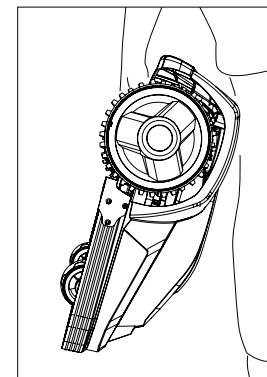

Note: The carry handle (10) includes two safety switches. Lifting the device by the carry handle will trigger the switches, deactivating the Robotic Mower.

SAFETY PRECAUTIONS

Lightning Protection

In order to prevent lightning damage to the machine, do not place the docking station under tall trees.

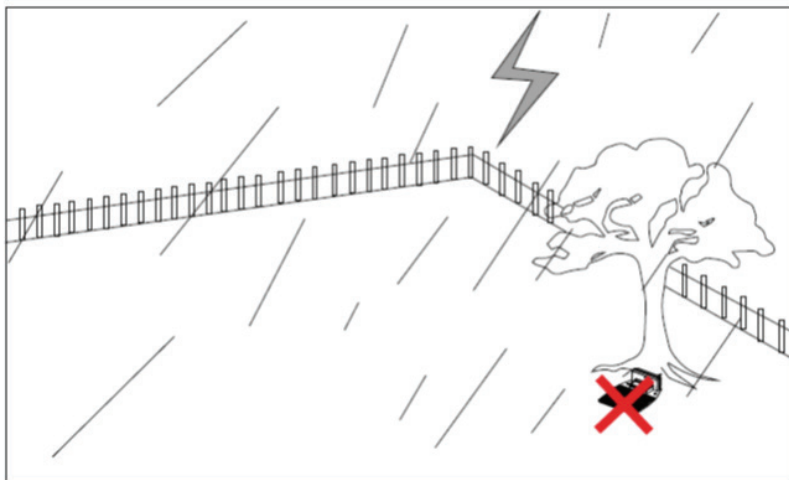

Operating the machine:

 **WARNING!** This machine can cause serious injury. Follow instructions below to reduce risk of accident and injury.

IMPORTANT
READ CAREFULLY BEFORE USE
KEEP FOR FUTURE REFERENCE

Preparation:

- Read the instructions carefully and make sure you understand them fully. Be familiar with the controls and the proper use of the machine.

SAFETY PRECAUTIONS

- Never allow children, persons with reduced physical, sensory or mental capabilities or lack of experience and knowledge or people unfamiliar with these instructions use the machine.
- Local regulations may restrict the age of the operator. Children should be supervised to ensure that they do not play with the appliance.
- The operator or user is responsible for accidents or hazards occurring to other people or their property.
- Ensure the correct installation of the perimeter boundary system as instructed.
- Periodically inspect the area where the machine is to be used and remove all stones, sticks, wires, and other debris which could cause damage to the machine or be unsafe.
- Periodically inspect to see that the blades, blade bolts and cutter assembly are not worn or damaged. Replace worn or damaged blades and bolts in sets to preserve balance.
- On multi-spindle machines, take care as rotating one blade can cause other blades to rotate.
- Never leave the machine unattended while other people such as children and pets are in the area.
- Never use the machine to level out uneven patches.
- If the blades no longer cut correctly or if the motor is overloaded, check all the parts of your equipment and replace the worn parts. If a more extensive repair is required, contact the customer service centre.

SAFETY PRECAUTIONS

Use:

- Never operate the machine with defective guards or without safety devices, for example deflectors and/or grass catchers, in place.
- Do not put hands or feet near or under rotating parts.
- Never pick up or carry the machine while the motor is running.
- Turn OFF / Power OFF the machine
 - before clearing any blockages.
 - before checking, cleaning or maintaining the machine.
- Start the Robotic Mower according to the instructions. When the main power switch (11) is in the ON position, make sure you keep your hands and feet away from the rotating blades.
- Never lift the Robotic Mower or carry it around with the mains switch is in the ON position.
- Do not let people use the mower who do not know how it works or behaves.
- Do not put anything on top of the Robotic Mower or its docking station.
- Do not use the Robotic Mower with defective blade discs, body, defective blades, screws, nuts etc.
- Avoid operating the machine in wet grass. Doing so can cause additional wear and tear, and will increase the amount of cleaning required.

SAFETY PRECAUTIONS

Work interruptions:

- After the machine has been turned off, the cutting cylinder will continue to rotate for a few seconds. Keep hands and feet well away.
- Only remove blockages when the machine is standing completely still.
- Switch off the power when the machine is transported, lifted or tilted.
- Never leave the machine unattended. Children should be supervised to ensure that they do not play with the appliance.



CAUTION!

The following below outlines measures to avoid damage and harm to both the Robotic Mower and the people using it.

Taking care of your machine:

- Switch off the power when the machine is to be carried across uneven surfaces, for example steps.
- Inspect the machine before each use. Never operate the machine if safety devices (e.g. impact protector, parts of the cutting facility or bolts) are missing, worn out or damaged. Check the power cable. To avoid imbalance, all tools and bolts should be changed as complete sets.

SAFETY PRECAUTIONS

- Only use spare parts and accessories that have been supplied or recommended by the manufacturer. The use of alien parts results in the immediate loss of all guarantee claims.
- Ensure that all nuts, bolts and screws are firmly tightened and that the machine is in a safe working condition.
- Never try to repair the machine yourself, unless you have been trained accordingly. All work that has not been listed in these instructions must only be carried out by authorised servicing agencies.
- Treat the machine with the greatest care. Always keep the tool clean. Follow the maintenance instructions.
- Never overload the machine. Always work within the specified capacity range. Do not use low-power machines for heavy-duty work. Do not operate the machine for purposes for which it is not intended.

Electrical safety:



CAUTION!

The following states how to avoid accidents and injuries due to electric shock:

- Before each use, carry out a visual inspection of the power and extension cord for any signs of damage or ageing. Damaged mains power cables increase the risk of electric shock.
- Connect the machine to a power socket with a residual-current circuit breaker that has a rated current of no more than 30 mA.

SAFETY PRECAUTIONS

- Always keep the extension cable well away from the cutting tools. If the power cable becomes damaged during work, instantly disconnect the power cable from the mains. **DO NOT TOUCH THE POWER CABLE BEFORE IT HAS BEEN DISCONNECTED FROM THE MAINS!** Risk of electric shock.
- The supply cord cannot be replaced. If the cord is damaged the appliance should be scrapped.
- Keep extension cable away from blades and other moving parts. They may damage the cable and result in contact with live parts.
- Check that the mains voltage is the same as indicated on the rating plate.

Maintenance and storage

- Keep all nuts, bolts and screws tight to be sure the machine is in a safe working condition.
- Replace worn or damaged parts for safety.
- Ensure that only the recommended replacement cutting blades are fitted.
- Ensure that batteries are charged using the charger supplied or recommended by the manufacturer. Incorrect use may result in electric shock, overheating or leakage of corrosive liquid from the battery.
- Servicing of the machine should be carried out according to manufacturer's instructions.

SAFETY PRECAUTIONS

- In the event of leakage of electrolyte, flush with water/neutralising agent, seek medical help if it comes into contact with the eyes.
- Store the appliance with battery pack fully charged at room temperature (around 20°C).
- Every deep discharge cycle decreases the capacity of battery pack. To prolong battery life, it is recommended to charge the battery every 6 months over extended periods of time without use.

Transport

The original packaging should be used when transporting the Robotic Mower over long distances.

To safely move from or within the working areas:

- Press the STOP button to stop the mower.
- Move the main switch button to the OFF position if you intended to carry the mower.
- Carry the Robotic Mower using the handle below at the rear. Carry the mower with the blade disc away from the body.

SAFETY PRECAUTIONS

Robotic Mower basic operating principles

- The Robotic Mower chooses its working direction randomly. It will mow your garden completely without leaving behind any uncut part within the area restricted by the chosen boundary.

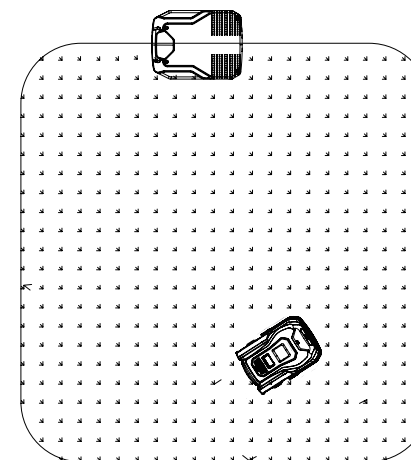

- You define the work area by installing the supplied boundary wire. Once the Robotic Mower detects the boundary wire, it will stop, move backwards and continue mowing in a different direction. It is important to ensure that the boundary is complete. Any objects you wish to protect within the boundary, such as a garden pond, trees, garden furniture or flower beds can also be protected using the boundary wire. The boundary wire must form one complete loop. If the Robotic Mower encounters an obstacle, such as a person, tree, pet or other general garden obstacles, it will stop, move backwards and continue mowing in a different direction.

SAFETY PRECAUTIONS

- If you need a narrow corridor to connect two patches of lawn within the boundary, the corridor should be at least 2 metres wide and max. 8 m long.

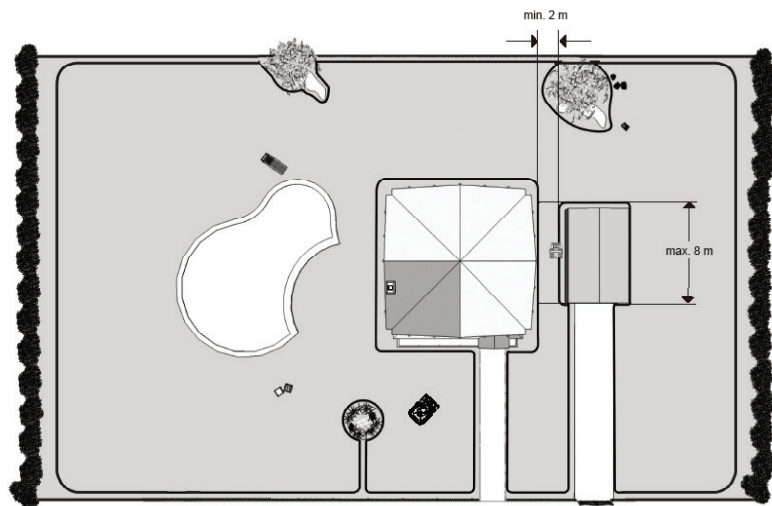

Note: If the Robotic Mower loses ground contact when hitting an obstacle, the blade disc will stop immediately to avoid any potential damage.

SAFETY PRECAUTIONS

Locating the docking station

- When the battery is running low, the Robotic Mower will automatically return to the docking station. It will approach the closest boundary wire and follow it anticlockwise (without cutting) back to the docking station. When fully charged, the Robotic Mower will automatically resume the interrupted working cycle. The launch direction from the docking station - clockwise - is hard-wired into the design and is impossible to change.

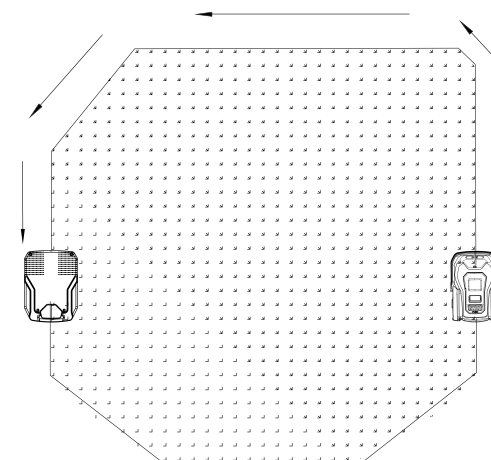

Recognising the boundary wire

- Note that before stopping and changing the direction, the Robotic Mower will overrun the boundary wire by 10 to 20 cm. Please keep this in mind when planning the boundary wire installation.

SAFETY PRECAUTIONS

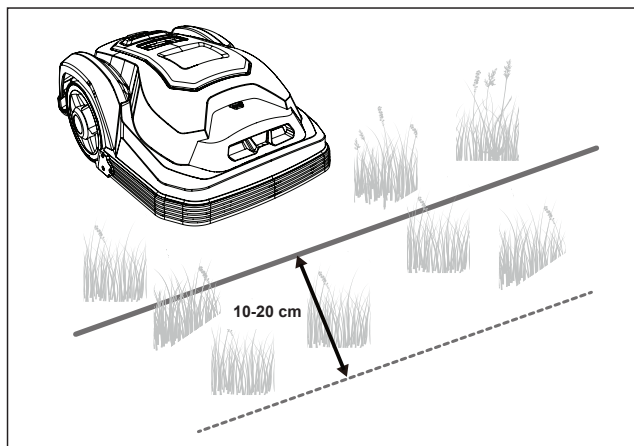

Starting and stopping while mowing

- If you want to stop the Robotic Mower at any time during cutting, press the STOP button (2). Pressing the STOP button will also open the top cover, providing access to the control interface. The Robotic Mower will not start working again until you have closed the top cover.

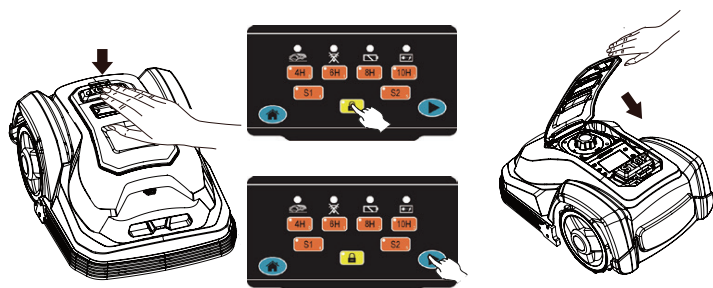

SAFETY PRECAUTIONS

Robotic Mower mowing limitations

- During first use, the Robotic Mower is set to work 7 days a week. You can adjust the daily working time to match your garden.
- In case a neighbour is using the same Robotic Mower, you will need to keep a distance of 0.5m between you and your neighbour's boundary wires. Otherwise, the two devices might interfere with each-other. Additionally, ensure that your docking station is positioned at least 10m away from your neighbour's boundary wires. Finally, ensure that the adjacent boundary wires are using different signals. Please refer to section "Signal setting" in order to select signal S1 or S2 for your installation.

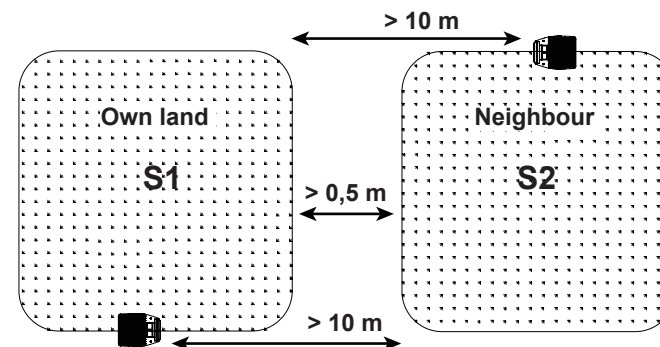

Below is a table showing the signal distances for each Robotic Mower. Please note your model and use this information as your guide when designing the boundary layout.

Model	Max field	Max. distance to wire
SA650B	650 m ²	12 m

SAFETY PRECAUTIONS

Robotic Mower cutting information

- The Robotic Mower has a cutting height setting between 20 mm to 60 mm. If the grass height exceeds 60 mm, cut it to 60 mm or below before using the Robotic Mower. Otherwise the load on the unit will be too large and the cutting efficiency will suffer, we recommend using an ordinary lawnmower or trimmer. Once the installation is complete, adjust the cutting height to the desired setting. Always start in a high cutting position and work your way down to the cutting height you want. Before adjusting the cutting height, always press the STOP button (2) to interrupt the cutting. Then turn the large dial to adjust the cutting height.

Note: Only adjust the cutting height while the Robotic Mower is switched off.

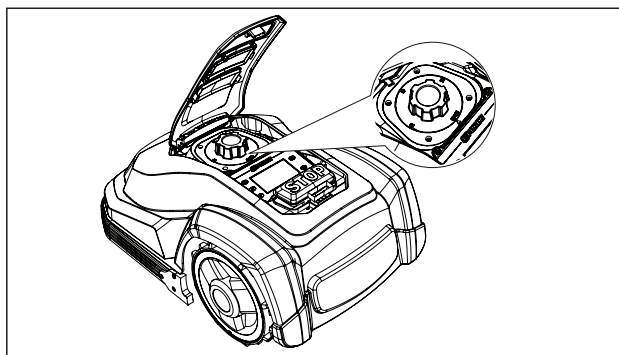

SAFETY PRECAUTIONS

- Do not use the Robotic Mower during lightning or thunder storms. In case of damage to the electronic circuitry, unplug the docking station and - if possible - disconnect the boundary wire.

The Robotic Mower cutting efficiency relies on sharp blades, so please keep these in good condition.

ASSEMBLY INSTRUCTIONS

Installation Guide

This chapter explains how to install the Robotic Mower. Please read this completely before you start the installation.

Introduction

We recommend creating a draft of your lawn, including all obstacles and how these should be protected. This makes it easier to find a good position for the docking station and how to correctly place the boundary wire around your garden perimeter protecting bushes, flower beds etc. You will also need some tools, like a hammer and wire cutters, pliers or scissors.

Cutting limitations

The Robotic Mower is equipped with collision sensors. These will detect any rigid and fixed obstacles higher than 100 mm, such as walls, fences and garden furniture. When triggered, the Robotic Mower will stop, reverse backwards and then continue mowing in a different direction. Still, protecting the obstacles using the boundary wire is the recommended long-term solution.

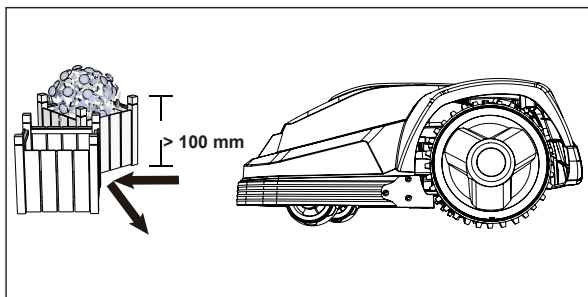
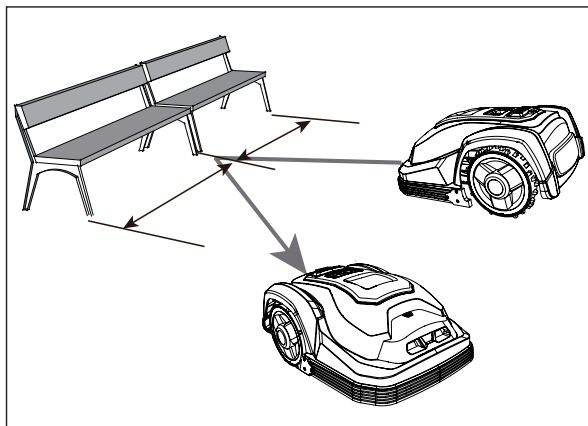

ASSEMBLY INSTRUCTIONS

Trees

The Robotic Mower treats trees as common obstacles, but if the roots of the tree are exposed and lower than 100mm, this area should be excluded using boundary wire in order to protect the tree root, cutting blades or rear wheels from damage.

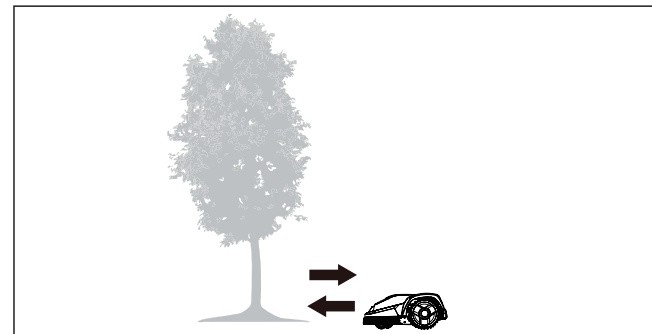

Stones

We recommend clearing the lawn of small (less than 100 mm high) rocks and stones and any stones with a round or sloped edge. The Robotic Mower might try and climb such rocks instead of recognising them as a barrier. A Robotic Mower getting stuck on such a stone requires user intervention to restart mowing. Contact with stones can result in damage to the blades.

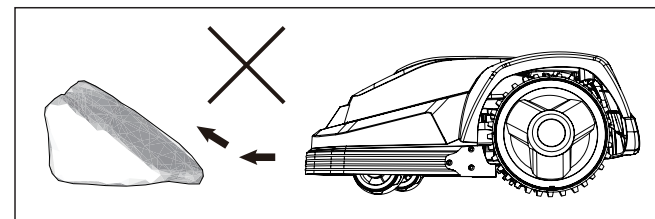

Slopes

The Robotic Mower can navigate slopes up to a maximum of 40% incline or decline.

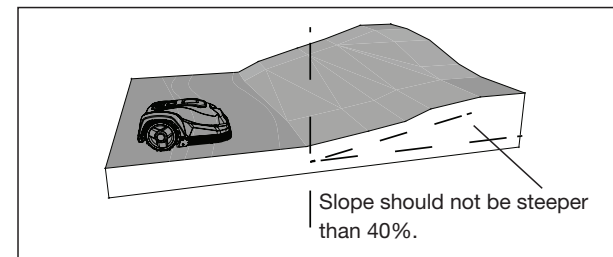

ASSEMBLY INSTRUCTIONS

The boundary wire should never run perpendicular to a gradient of more than 10°. Likewise, please allow a corridor of at least 2m between a 10° or steeper slope and the boundary wire. Otherwise, the faster downhill speed may cause the Robotic Mower to overshoot the boundary wire, especially on wet and slippery ground.

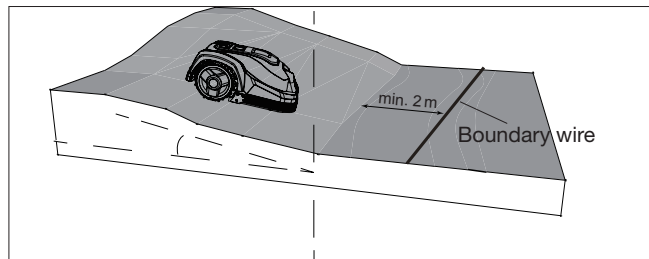

Paths, Driveways and Roads

If an elevated driveway crosses your lawn, it is advised to keep it outside of the boundary wire.

Please allow a safety distance of 40 cm between driveway and boundary wire.

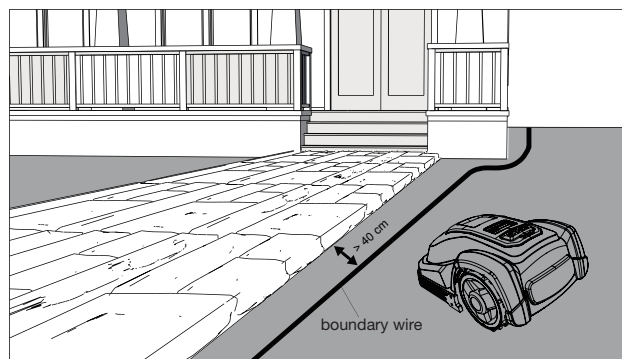

ASSEMBLY INSTRUCTIONS

If the driveway and lawn are at the same level, feel free to use the boundary wire to create a corridor. This allows your Robotic Mower to cross the driveway and reach the opposite lawn.

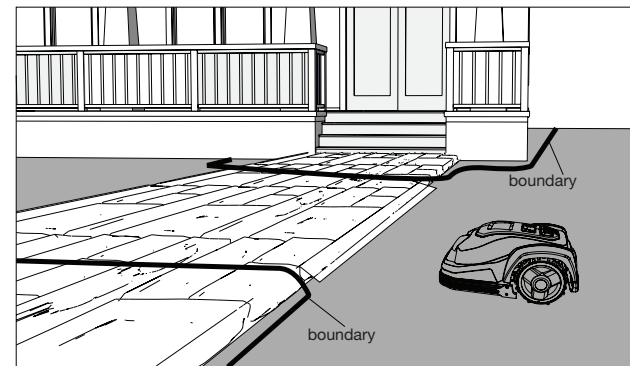

Uneven lawn surfaces

Uneven lawn areas may cause the blades to touch the ground. We recommend leveling the lawn before using your Robotic Mower or excluding uneven areas using the boundary wire.

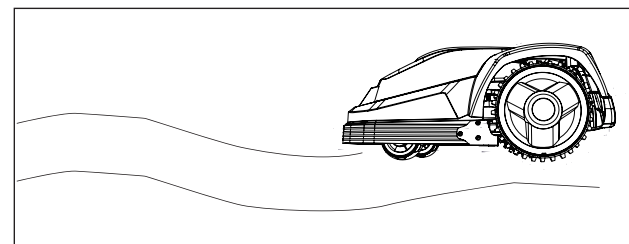

ASSEMBLY INSTRUCTIONS

Flowerbeds

Use the boundary wire to exclude any flowerbeds from the cutting area. There are two options for the two lengths of boundary wire running between the flowerbed and the outer boundary:

- 1) Keep the distance between the parallel wires above 10 cm. This way, the Robotic Mower will recognise the boundary wire as an ordinary obstacle. When cutting, it will "bounce" off it as usual. When following the boundary wire back to the docking station, it will take the detour around the flower bed.

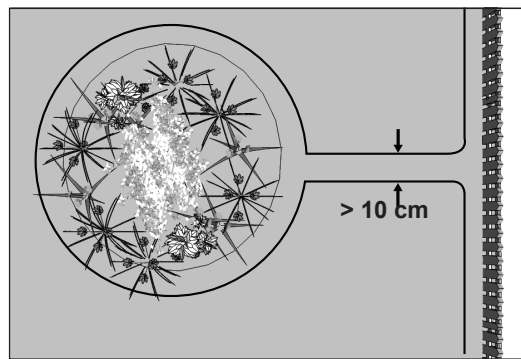

- 2) Alternatively, keep the distance between the two parallel wires below 5 mm. Do not cross the wires - see below. This way, the Robotic Mower will not recognise the wires and travel across them unhindered. This option requires placing an obstacle on the boundary wire around the flowerbed. Place the obstacle, for example a large rock or pole, near position A indicated on the below illustration. The obstacle must be surrounded by a flat area of about 1 m x 1 m, without any slopes. This obstacle will allow the machine to exit the circle.

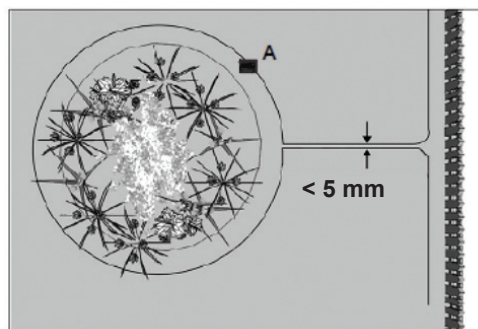

ASSEMBLY INSTRUCTIONS

Ponds and Pools

While the Robotic Mower is protected against rain and spray water, being submerged is likely to cause severe damage to the electronic parts.

Therefore, it is imperative to exclude any pools from the cutting area. For added safety, we recommend placing a fence around the pool.

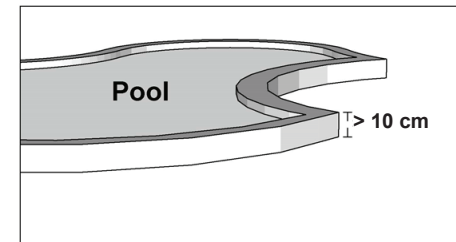

General Dos and Don'ts

Do not run the boundary wire directly above an ordinary power cable.

The power cable's electric field may distort the boundary signal.

Never cross two boundary wires! This will distort the radio signal and cause erratic behavior of the Robotic Mower.

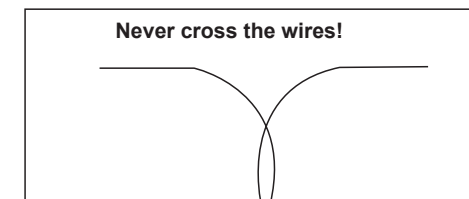

If you have created a boundary corridor inside your working area, the corridor should be at least 2 m wide and a max length of 8 m.

If a corridor is too narrow or too long, the Robotic Mower might not be able to navigate it from one end to the other.

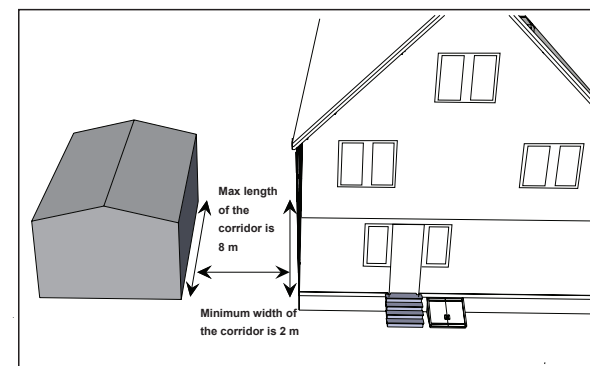

ASSEMBLY INSTRUCTIONS

Keep in mind that flowers, bushes and surrounding shrubbery will change in size over a season. Please allow sufficient space between boundary wire and other plants to avoid interference year-around.

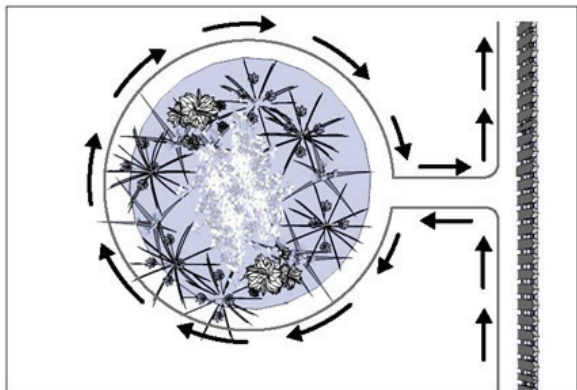

Marking out the Robotic Mower's working area

Now that you understand the basic principals of how the Robotic Mower works, the next step is to mark out the working area with boundary wire by referring to your garden plan. This is a very important part of the installation, so please take care. Starting from the docking station, the boundary wire must be set in one continuous loop without any breaks or crossings. Connecting the end to the docking stations second connector will complete the circuit.

Where appropriate, use the included ruler to check the 40 cm required distance.

First, locate the best position for your docking station. Be aware that it needs a permanent connection to the mains, so take into account the location of the nearest power outlet. The included supply cord has a length of 9 m.

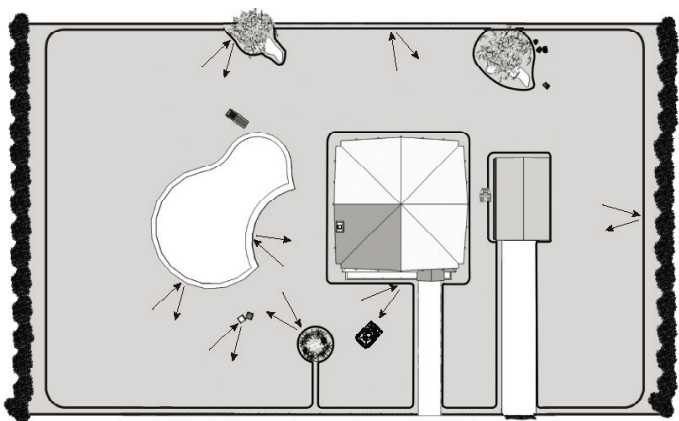

ASSEMBLY INSTRUCTIONS

The docking station (5) must be placed on a flat surface, at ground level.

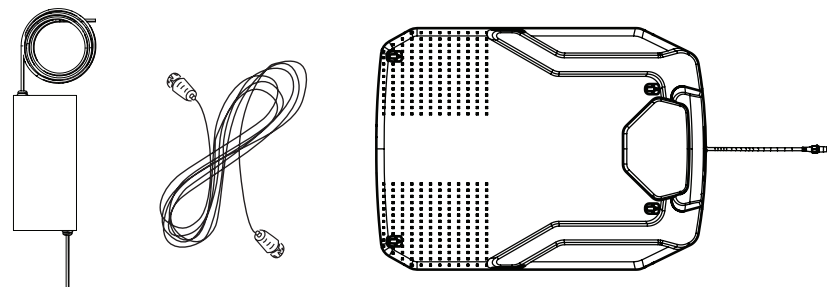

To ensure the Robotic Mower can return to the docking station smoothly, leave 2m of straight wire to the front of the docking station and 1m to the side facing the cutting area. Use a shaded location for the docking station, as a lower temperature while charging is beneficial to the battery.

Important: Place the docking station on an even, flat surface away from ponds, pools or stairs.

We recommend suitable protection from the elements, for example a robot port or garage.

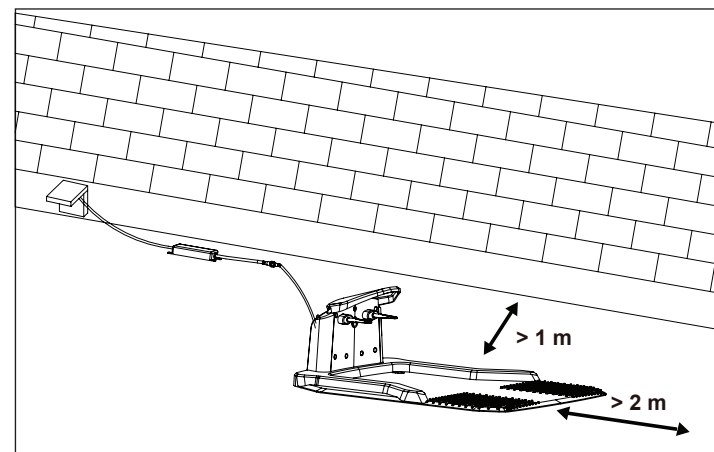

Pay attention to protect cable!

ASSEMBLY INSTRUCTIONS

Do not place the docking station too close to a slope, such as at the top of a hill or the bottom of a furrow. Avoid left and right inclination in excess of 5 degrees.

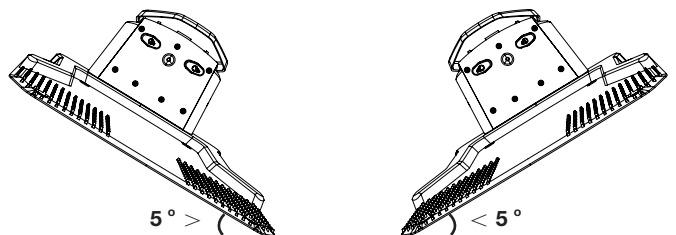
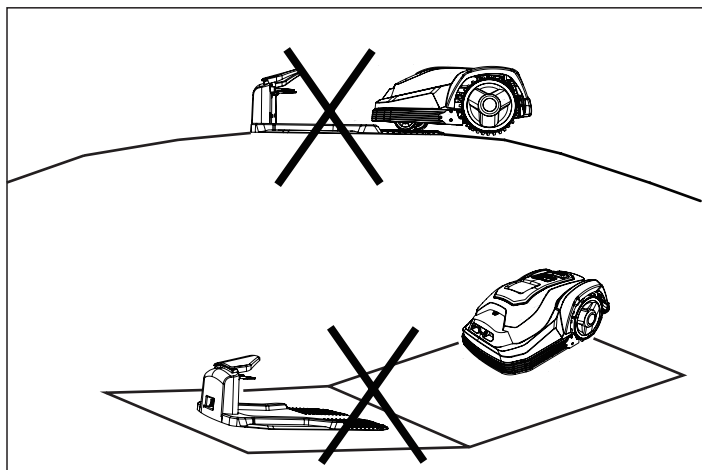

If your lawn has a soft or uneven surface, we recommend fortifying the area around the docking station with a grass protection mesh. Otherwise, the repeated stress of the rear wheels can damage the turf.

Once the position of the docking station is confirmed and mains electrical connection is laid out, do not connect to the mains power, finish all boundary layout work before connecting the docking station to the power supply.

ASSEMBLY INSTRUCTIONS

Pegging out the boundary wire

We strongly recommend mowing the lawn to 60 mm or less before laying out the boundary wire. Burying the boundary wire is entirely optional. Still, the closer to the ground you lay out the boundary wire, the lower the chance of tripping over it or damaging it when mowing the lawn.

In a very short time, the wire will be covered by grass. As the voltage is only 32 V, there is no risk of electric shock.

Unpack the boundary wire (18) and locate the free end. Mark the desired path of the boundary wire with the fixing pegs (15).

Use the included ruler (16) to ensure the required 40 cm distance between wire and obstacles.

The recommended distance between two pegs is about 80 cm in straight lines, and less in tight curves. Note that the pegs' hook and wire slit always faces the outside of the boundary. When first planting the pegs, do not drive them fully into the ground. Use a light hammer to drive them in a little bit. Also locate the fixing pegs and lay each one on the lawn at approximately the correct distance from lawn edges (40cm) and obstacles.

There is a gauge supplied for this.

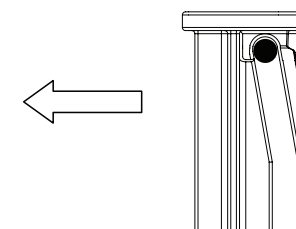
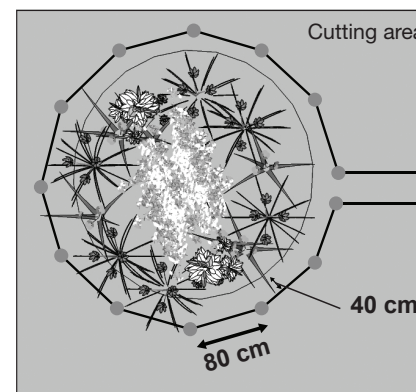

The pegs should be knocked into lawn with wire location to boundary outside like shown.

Once all pegs are in position, lay out the boundary wire. Start from the docking station. Run the wire through the peg's hook and wire slit one-by-one. Do not tighten the boundary wire too much to prevent wire damage. Carefully prevent any kinks, knots, etc. When cutting the wire, we recommend leaving at least 1 m spare wire to allow for adjustments.



Note: The pegs are not suitable for fixing the boundary wire on hard surfaces, e.g. when running the boundary wire across a driveway. Instead, use appropriate screws and plugs. Be sure to use insulation washers to protect the wire insulation.

ASSEMBLY INSTRUCTIONS

Only use the included waterproof boundary wire connectors (17) to join together two pieces of boundary wire.

See below for some further sketches giving more distance guidelines.

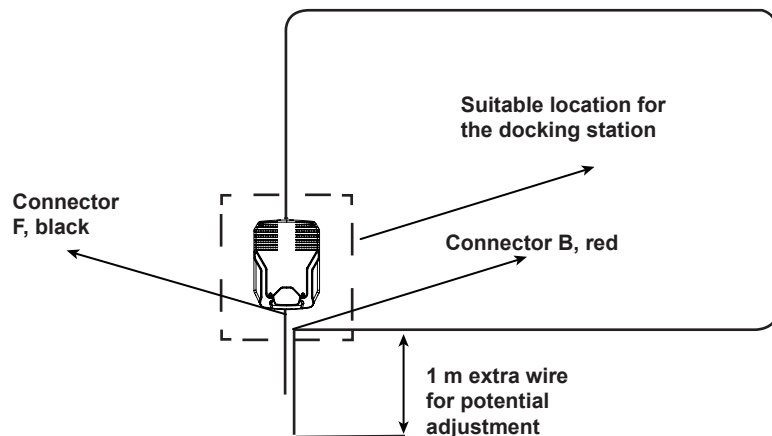

Avoid right angles when running the boundary wire around a corner. Instead, separate into two 45° angles.

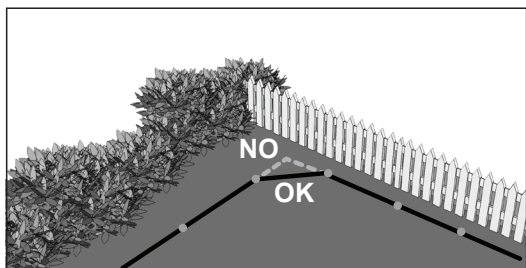

In case the included boundary wire is too short for your garden, more is available from our service team.

The wire's total length must not exceed 300 m.

ASSEMBLY INSTRUCTIONS

Prepare the boundary wire for the docking station

Use a wire stripper to remove 10-15 mm insulation from each end. Twist the threads tight.

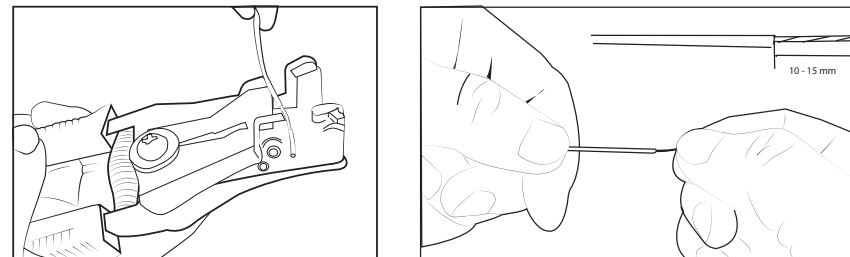

Connect the docking station to the boundary wire

Place the docking station on the end of the boundary wire so that the wire runs lengthwise below the middle of the docking station. Connect that end to the left (black) connector marked "F" (front). Connect the other end to the right (red) connector marked "B" (back).

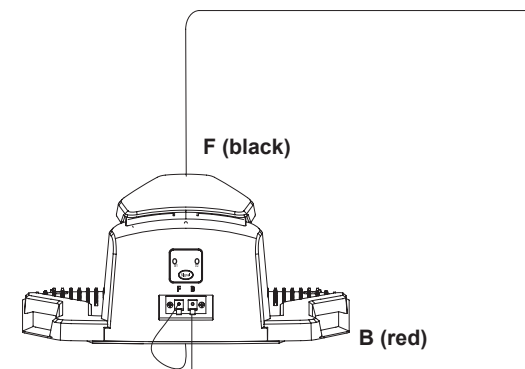

IMPORTANT INFORMATION

Double check that the charger connections are as shown below. Even if there is a blue light, if the connectors are wrongly connected the machine will not work.

ASSEMBLY INSTRUCTIONS

After connecting the "F" and "B" connectors to the docking station, the docking station can be fixed down with the boundary pegs.

Before fixing the docking station, please check again that the above mentioned conditions are met:

- Even surface within range of power supply
- 2 m straight boundary in front,
- Inclination less than 5 %
- Surplus boundary wire tucked under the docking station for protection, outside the boundary.

Once the docking station is fixed, connect the charger extension cable (14) to charging base. Now, connect the power supply to the mains outlet. After a brief self-test, one blue LED on the docking station should light up. If all LEDs stay dark, double-check the mains outlet and the power supply. If anything other than a single blue LED lights up, please refer to the chapter on trouble-shooting.

Turn on and test the installation

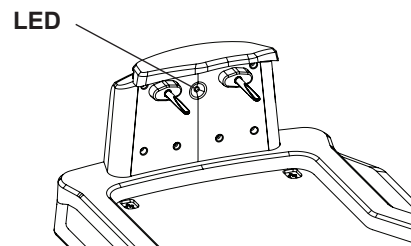

Once the blue LED confirms all is OK, test the Robotic Mower's function. Check the LED regularly to ensure fixing the boundary wire has not affected the connection. Then place the Robotic Mower in the working area, a few metres beside the docking station.

Set the main power switch (11) to "ON". The Robotic Mower will power-up and start a self-test, but will not start working at this time.

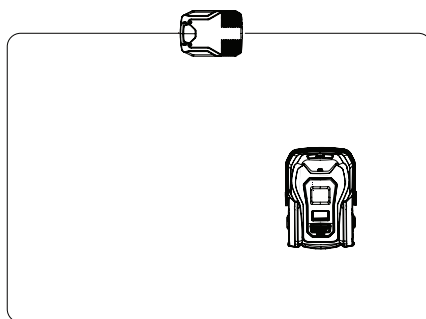

ASSEMBLY INSTRUCTIONS

Press down on the large STOP button (2) to open the top cover and access the controls. Activate the button marked " " (situated on the left part of the display) and press down the top cover to close it.

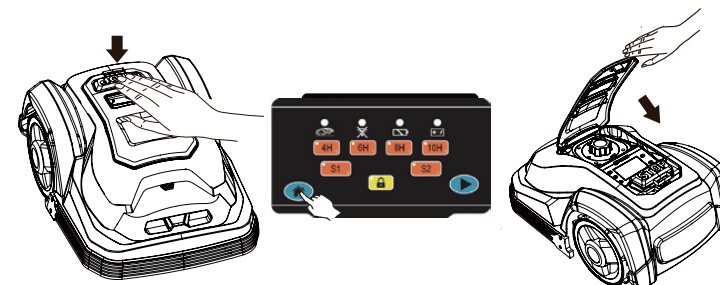

Once closed, the Robotic Mower will automatically return to the docking station by locating and following the boundary wire in anti-clockwise direction. If the Robotic Mower fails to dock correctly, move the docking station to a more suitable position.

Once the device has docked, the " " symbol will start flashing. This indicates that the battery is charging correctly.

After initial installation, the Robotic Mower will remain in the docking station until the battery is fully charged.

Successful docking and charging indicates that you have found a suitable position for the docking station. It is now time to fix it in position by fully driving the pegs into the ground. Take care not to damage or kink the surplus wire stored under the docking station.

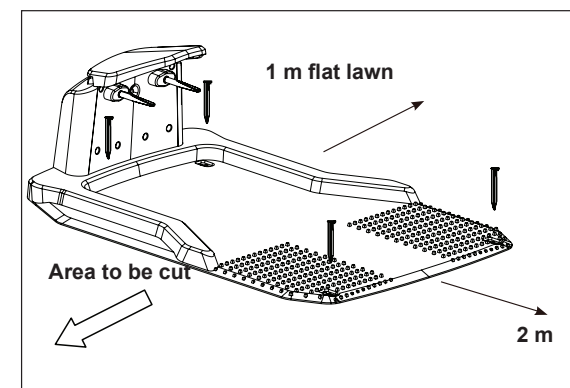

OPERATION

Control Panel

Once the Robotic Mower is fully charged, it is ready for programming.

While the default factory settings will suit the majority of users, it is worth familiarising yourself with the options available.

To start programming, press down on the large STOP button (2) to open the top cover and access the controls.

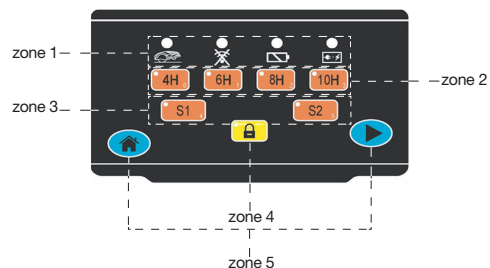

The control panel has five functional areas.

- Zone 1: Status indicator LEDs
- Zone 2: Working time setting
- Zone 3: Signal setting
- Zone 4: Locking button
- Zone 5: Home & start button

Lock and Unlock

Unlock

A blinking LED above the lock button [🔒] indicates that the control panel is locked. To unlock the control panel, enter the PIN code.

There is no factory-default PIN. Instead, press the lock button [🔒] four times.

If the LED goes out, the PIN entry was successful and the control panel was unlocked.

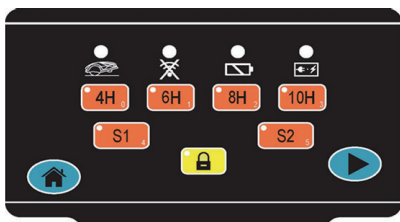

OPERATION

Lock

Control panel will be locked when the Robotic Mower is restarted using the mains power switch.

Also, you can simply press the lock button [🔒] to manually lock the control panel.

Change PIN code

The analog keyboard

The panel is equipped with a 5 key numerical keyboard.

Use "4H" for 0, "6H" for 1, "8H" for 2, "10H" for 3, "S1" for 4, and "S2" for 5.

Changing the PIN Code

- 1) Switch OFF the mains power switch (11)
- 2) Press and hold the lock button [🔒].
- 3) Hold down the lock button [🔒] while switching ON the main power switch (11). After about 6 seconds, all LEDs on the control panel will start flashing fast.
- 4) Release the lock button [🔒].
- 5) Within 6 seconds, enter your new PIN-Code.
The Robotic Mower will confirm the changed PIN with a single beep.
- 6) All LEDs will go out and the Robotic Mower will reboot. Once the LED of the lock button [🔒] flashes, the reboot is complete. You can now unlock your Robotic Mower with your new PIN.

Note: If you do not remember your PIN code, please set a new PIN as described above.

It is not possible to reset the device to the default PIN code of "4x [🔒]"

Status indicator LEDs

Lift signal



A red LED above this symbol shows that the lift sensor has triggered.

Note: Vibrations or collisions can also trigger the lift sensor.

If this sensor is triggered for less than one second, the Robotic Mower will resume its work schedule immediately.

If the lift sensor is triggered for more than 1 second but less than 8 seconds, the Robotic Mower will stop operating for a short amount of time, then restart. If the Robotic Mower's lift signal is triggered for more than 8 seconds, this will trigger the anti-theft system. The device will lock itself and an alarm will sound.

Boundary wire signal

The boundary wire emits an electromagnetic signal. The Robotic Mower uses this signal to determine if it is within the cutting area.



The red LED above this symbol flashes when the device does not receive the "within boundary" signal. In this case, the Robotic Mower will stop mowing immediately.

Low battery symbol



This LED will turn on when the battery charge is low. In this case, the Robotic Mower will immediately return to the docking station.

Charging



This LED will flash while the battery is charging. A continuous LED indicates a fully charged battery.

While charging, the boundary signal receiver is powered off to save energy. This can cause the "boundary wire signal" LED to turn on.

Working time setting



The above buttons let you choose the mower's daily working hours.

Please refer to the below table for the recommended working time per day, depending on the working area.

The current working time is indicated by the illuminated button.

A flashing button means that the device has already worked the respective hours that day.

Note: The average working time with a fully loaded battery is less than the minimal working time setting of 4 h. When the Robotic Mower returns to the docking station, the clock does not stop. The charging time counts as working time.

Recommended time per day(hour)	
300m ²	3 hours
650m ²	7 hours

After the working time is selected, the corresponding LED will be lit up LED flash means out of working time.

Signal setting



To avoid interference with a second Robotic Mower, there are two different boundary signals available.

Be sure to choose the same signal (S1 or S2) for the docking station and the Robotic Mower.

Use the control at the back of the docking station to switch between signal S1 and S2.

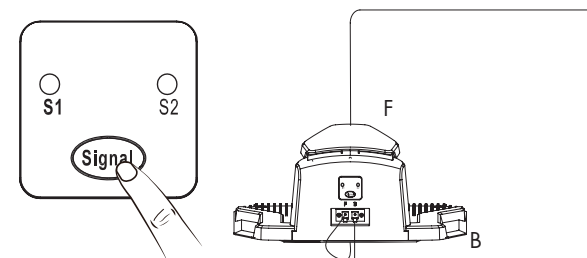

OPERATION

Press S1 or S2 on the control panel to match the Robotic Mower's signal to the docking station's. The button of the currently active signal is illuminated.



Home & start button

Press the START button and close the top cover and the Robotic Mower will begin cutting. When the programmed work time is passed, the device will return to the docking station.

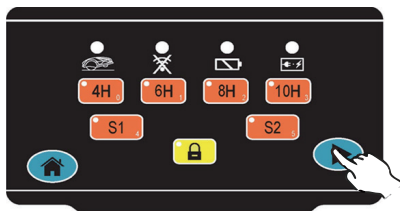

Important note:

The Robotic Mower will start working again the following day at the same time as when the start button was pressed initially.

Example: You start the Robotic Mower on Monday at 15:30 with a working time of 4 h. The device will work on Monday until 19:30 and then return to base. On Tuesday 15:30, the Robotic Mower will automatically start again working for the same 4 h. This will continue every day until interrupted by the user.

HOME

Pressing the HOME button and closing the lid will send the Robotic Mower back to the docking station for a complete recharge. Note this will not stop the current programming. If the working time has not run out when charging is complete, the device will start cutting again. It will also start working again on the following day.

STOP

To interrupt the automatic working schedule, press the STOP button to open the top cover, and close it again without pressing any control button. The Robotic Mower will beep five times to confirm the interruption. It will not resume working without further user commands.

OPERATION

Edge cutting

As the first cutting action of each day, the Robotic Mower will trim the lawn edge. Therefore, while cutting, it follows the boundary wire in clockwise direction.

This function only engages when the Robotic Mower launches from the charging station.

Charging Information

The Robotic Mower will go back to docking station by itself in the following situations:

1. When you press the  button and close the keypad top cover.
2. When out of working time set.
3. When less than 30 % battery charge is remaining.

Note: If the Robotic Mower fails to dock to the docking station, it will return to the cutting area and try again.

Note: If the ambient temperature around docking station is higher than 40 °C, the device will stop charging to protect the battery. Once the temperature drops sufficiently, charging will resume automatically.

CLEANING/MAINTENANCE



Work that has not been described in these instructions must be carried out by a servicing agency authorised by the manufacturer. Only use original parts.

Maintenance

Check and clean your Robotic Mower regularly and replace worn parts if necessary. Preferably use a dry brush, a damp cloth or a sharpened wooden piece. Never use flushing water.

Following these maintenance instructions can extend your Robotic Mower's service life.

Battery Life

The Robotic Mower has a maintenance free Li-ion battery, with an estimated life of more than 2 years (depending on treatment and usage).

Winter Storage

During winter, keep your mower, docking station and power supply in a dry place.

We recommend a shed, garage or preferably store it indoors.

Prepare your device for winter storage as follows:

1. Fully recharge the battery.
2. Set the main power switch to "OFF".
3. Thoroughly clean your Robotic Mower.
4. Unplug the power supply from the mains outlet.
5. Disconnect the power supply from the docking station.
6. Disconnect the boundary wire from the docking station. Lift up the docking station, and clean it. The boundary wire can remain outside. However, it is imperative to protect the wire against corrosion. We recommend a water-free grease or suitable sealing tape.

If available, repack the product in the original packaging.

Alternatively, our service centre offers a winter service for your device. This will include a check-up of all parts and - if available - a software upgrade.

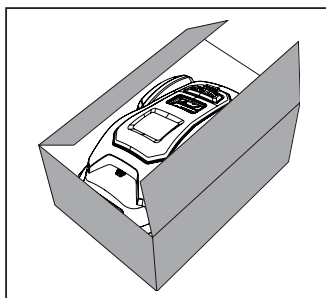

CLEANING/MAINTENANCE

Preparing for spring

After winter storage, please clean the charging contacts on both the Robotic Mower and the docking station.

Use a fine abrasion paper or a brass brush; this will help to achieve the best charging efficiency and avoid any charging interference.

Cleaning and Maintenance

It's important to keep your Robotic Mower clean.

The mower will deal with slopes easier when the wheels are clean. Sharp cutting blades need less power and will result in cleaner cuts.

Remember to turn off the main power switch (11) before starting any maintenance. Use protective gloves when handling the blades! Never use a high pressure washer, garden hose or running water when cleaning the device.

Cleaning the mower body

As your Robotic Mower is battery powered you need take care when cleaning. Remove rough dirt with a soft brush. Use a manual water spray with mild household detergent for intensive cleaning. Wipe off any residue after cleaning with a moist rag.

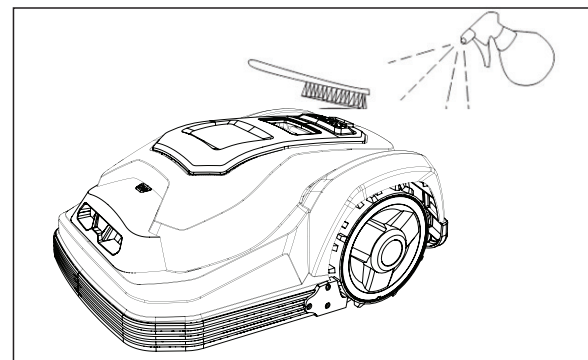

CLEANING/MAINTENANCE

Cleaning the underside

Ensure the main power switch (11) is in OFF position. Wear protective gloves. Turn the Robotic Mower onto its side to expose its underside. Clean the blade disc and frame using a soft brush or damp cloth. Rotate the blade disc to make sure that it moves freely, and check that the blades can turn on their pivots and no grass is obstructing them.

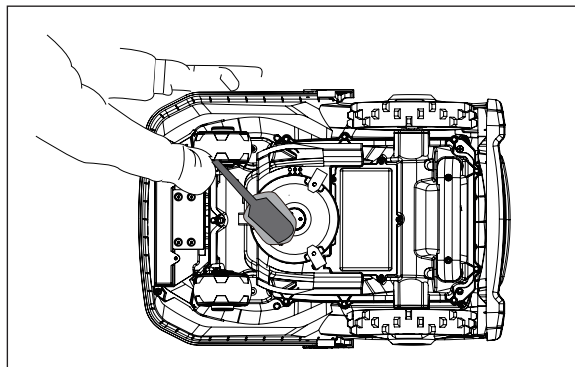

Clean the contact pins and the charging strips

Using wire wool, metal cleaner or very fine grade emery paper, clean the contact pins and the charging strips on your mower and docking station. Remove any debris, leaves, or grass clippings around the contact pins and charging strips to ensure efficient charging.

Reversing or replacing the blades



WARNING!

Ensure the Robotic Mower is completely shut off before cleaning, adjusting or replacing the blades. Always wear protective gloves.



WARNING!

To ensure maximum cutting efficiency and safety, always use recommended replacement blades and blade mounting parts when replacing.

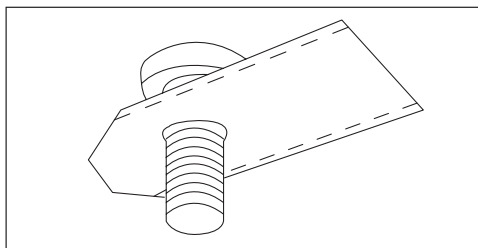

CLEANING/MAINTENANCE

Your Robotic Mower has three blades, fixed to the blades disk.

Unless damaged by hard obstacles, these blades can last for up to five months of everyday use.

Weekly inspection of the blades and the fixing screws is required. Note that the blades are double-edged. Once the first side is blunt, loosen the fixing screw. Turn the blade upside-down and fix it again with the fixing screw. After tightening the fixing screw, verify that the blade can rotate freely around the screw.

A set of spare blades is included with the Robotic Mower. More are available from customer support. The blade's spare part number is 846210.

Only use original spare parts. For best performance and avoiding imbalance, always turn or replace all three blades at the same time.

Replacing the battery

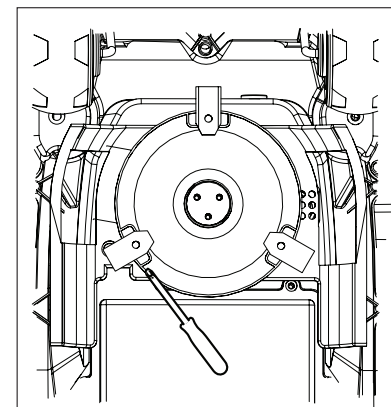

While the actual battery life will depend on usage and environmental factors, the typical service life is several years. Spare batteries are available from customer support. To replace the battery, please follow the instructions below.

- 1) Ensure the main power switch (11) is turned OFF. Clean the underside as instructed.
- 2) Set the Robotic Mower to the lowest cutting height.
- 3) Turn the mower upside-down. Remove the 5 screws fixing the battery compartment's lid. Note one screw is partially covered by the blade protector and is only accessible through a service hole.
- 4) Pull out the battery and disconnect it from the Robotic Mower.
- 5) Carefully clean the lid and the edge of the battery compartment. Debris may allow excessive water to enter the battery compartment, causing major damage to the device.
- 6) Connect and insert the replacement battery, close the compartment and fix the lid with 5 screws. Do not turn on the Robotic Mower before placing it back on its wheels - beware of sharp blades!

CLEANING/MAINTENANCE

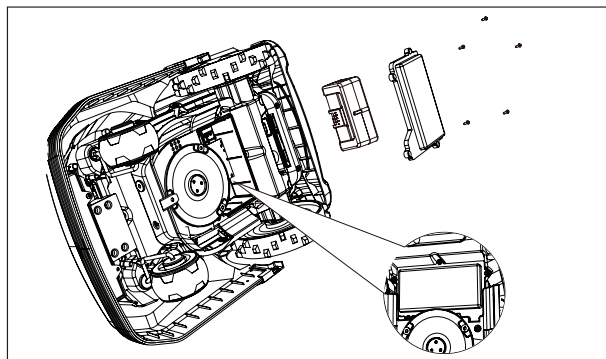

Short-time storage

- Store the machine in a dry place well out of reach of children.
- Do not wrap nylon sacks around the machine, as this could result in the formation of moisture.

TROUBLESHOOTING



Troubleshooting for the docking station

	LED	Description
1	Blue light on	Normal
2	Blue flash, Red off	Docking station internal error, boundary wire OK
3	Red flash, Blue off	Docking station OK; boundary wire connection is poor or the Robotic Mower is charging.
4	Red and Blue flash	Docking station internal error; boundary wire connection is poor or broken

Troubleshooting for the Robotic Mower

Nr.	Message	Symptom	Action
1	NONE	Robotic Mower cannot dock with docking station	<ol style="list-style-type: none"> 1. Check if boundary wire under and in front of the charger is in a straight line. 2. Check that the docking station's position is suitable as explained in this manual.
2	NONE	Robotic Mower runs in circles while mowing or while following boundary wire back to docking station.	<ol style="list-style-type: none"> 1. Verify that no power cable runs parallel and in close proximity the boundary wire. If necessary, reposition the boundary wire. 2. Check if a front wheel is stuck. 3. If a neighbor has a similar Robotic Mower, the signals may interfere. Try setting your docking station and Robotic Mower to the alternative boundary signal. 4. Driving motor may be damaged, please contact customer support
3	NONE	The Robotic Mower is very noisy.	<ol style="list-style-type: none"> 1. Inspect the blade fixing screws; tighten if necessary. 2. Inspect the blades for damage; replace if necessary. 3. Grass too high. Increase cutting height. Alternatively, mow the lawn with an ordinary lawnmower firstly, choosing a cutting height just above the desired cutting height. 4. Cutting motor failure, please call after sales service
4	NONE	Mower remains at or returns to docking station when pressing START and closing the lid.	<ol style="list-style-type: none"> 1. Check if the mower already completed the programmed working time for that day. 2. Check if the battery is very low
5	 LED flash	Lift-sensor triggered	<ol style="list-style-type: none"> 1. Too-high and dense grass (taller than 60 mm) may cause the Robotic Mower to lift. Mow the lawn with an ordinary lawnmower. 2. Check the mower is free from obstructions.

TROUBLESHOOTING

Nr.	Message	Symptom	Action
6	 LED flash	The Robotic Mower does not receive the boundary wire signal. (Robotic Mower placed inside boundary area.)	<ol style="list-style-type: none"> 1. Verify that the docking station indicator light is blue. If not, refer to installation instructions and docking station troubleshooting. 2. Verify that both docking station and Robotic Mower are set to the same signal, S1 or S2. 3. Check if the boundary wire is connected in the correct direction. 4. Disconnect the boundary wire from the docking station, and reconnect it the opposite way.
7	 LED flash	Battery voltage is too low to perform normal mowing.	<ol style="list-style-type: none"> 1. Normally if voltage is low, the mower should automatically return to the docking station. 2. If not, please carry your mower manually to docking station when it has stopped on the lawn.
8	 LED flash	Charging	Wait for battery to recharge.
9		Reset factory defaults	<ol style="list-style-type: none"> 1. Switch OFF the device. 2. Place Robotic Mower on flat, even surface. 3. While pressing and holding the START button, switch ON the device. 4. The Robotic Mower will boot up. All LEDs flash. 5. Release START button. Factory reset is complete. <p>Note: The Robotic Mower must stand on a flat surface, because the inclination sensors are also zeroed.</p>

DECLARATION OF CONFORMITY

Declaration of Conformity
We
MEROTEC GmbH
Otto-Brenner-Str. 8
47877 Willich, Germany

Declare that the product:
Description: 28V Robotic Mower
Model No. SA650B
Function: Cutting grass

Conforms to the following directives and standards

Machinery Directive 2006/42/EC
EN 60335-1:2012+A11+A13+A14+A2, EN 50636-2-107:2015+A1+A2, EN 62233:2008
Radio Equipment Directive 2014/53/EU
NB0123, TUV SUD Product Service GmbH Ridlerstraße 65.80339 Munich.Germany Certificate No:TPS-RED001232 i04
EN 55014-1:2017;
EN 55014-2:2015;
EN 301 489-1 V2.2.3;
EN 301 489-3 V2.1.1;
EN 300 328 V2.2.2
EN 301 489-17 V3.2.4
Draft EN 303 447 V1.2.0
EN62311:2008
RoHS Directive 2011/65/EU
WEEE Directive (2012/19/EU)
Authorized Signatory



Signature: _____
Place: Willich
Name: Roland Menken
General Manager
Date: 2021-09-18

MEROTEC GmbH
Otto-Brenner-Str. 8
47877 Willich, Germany

