



# YARD FORCE®

FOR LIFE ON THE GO

LS C13

GB

## 20V PRUNING SAW

Original Instructions

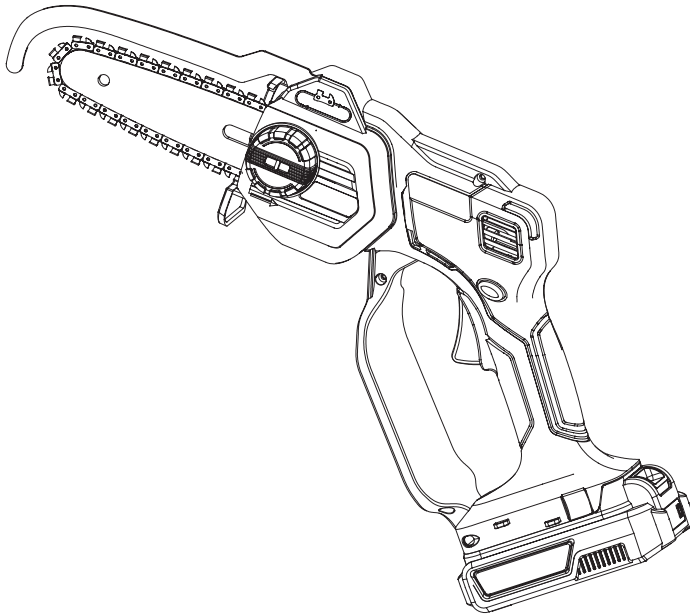

**READ & UNDERSTAND  
INSTRUCTION MANUAL**

Save all warnings and instructions for future reference.

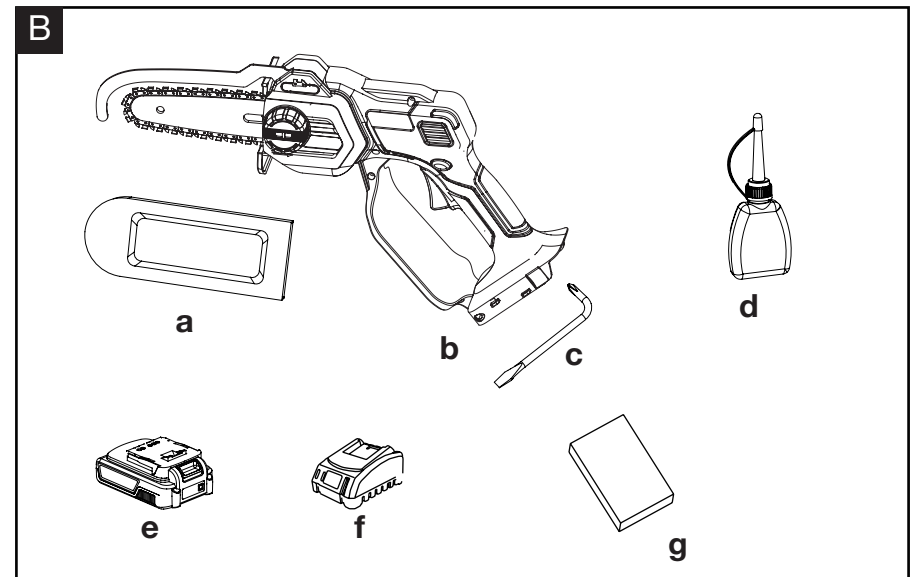
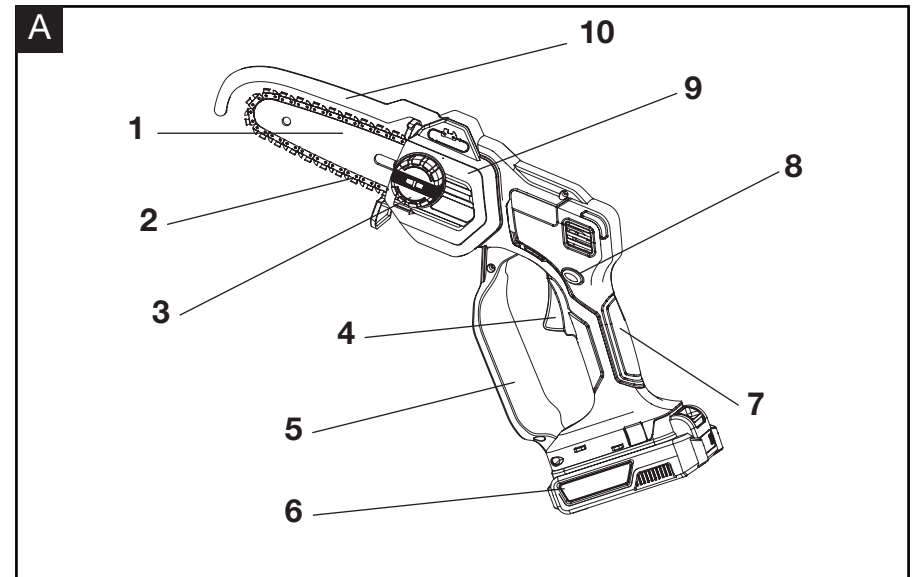

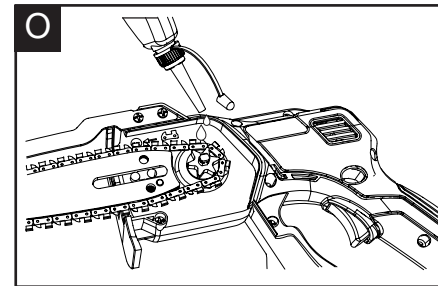
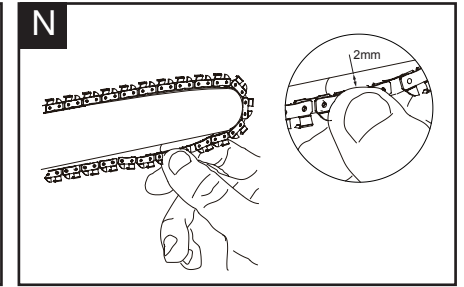
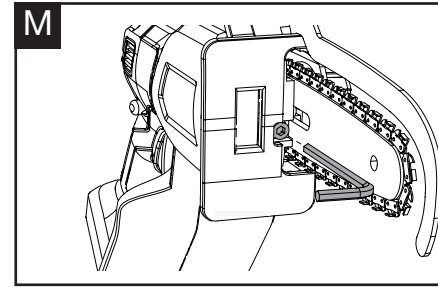
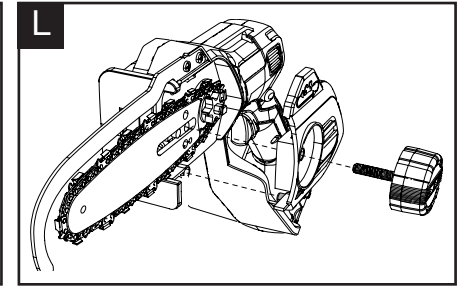
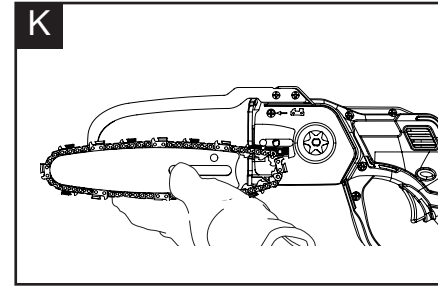
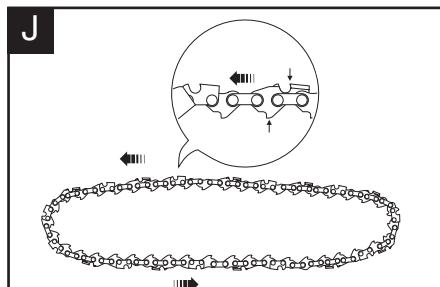
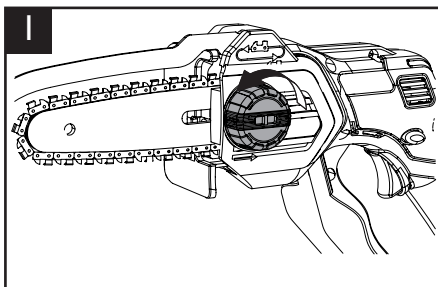
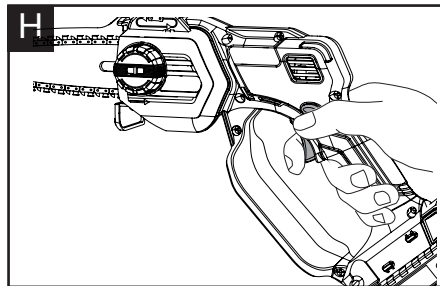
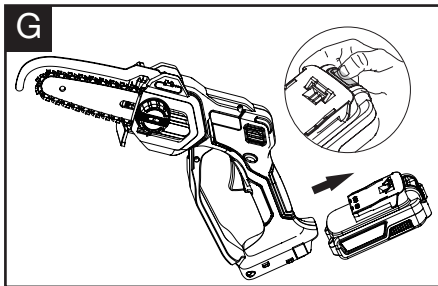
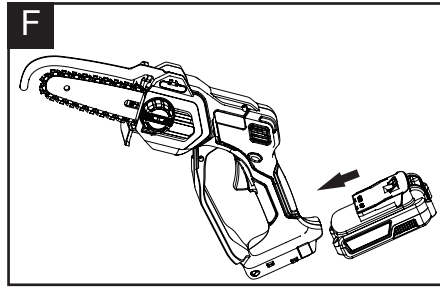
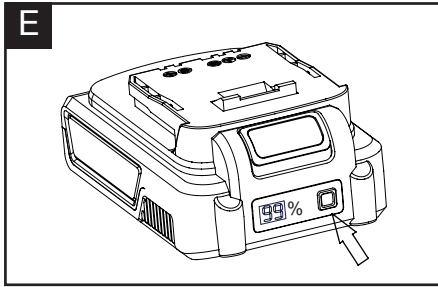
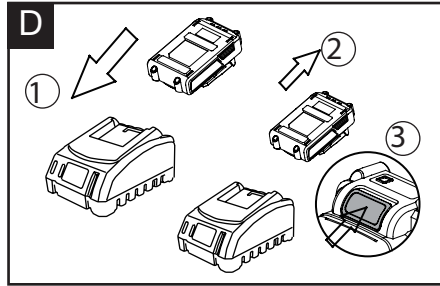
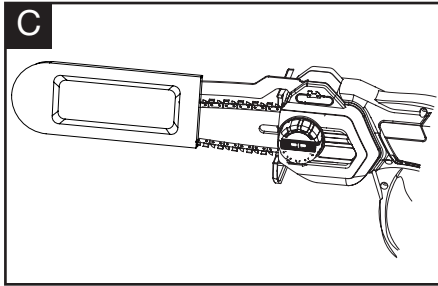

### CONTENT

Intended use	07
General safety warnings	07
Product safety warnings	14
Symbols	19
Technical data	23
Description of product	24
Operation	25
Maintenance and storage	29
Troubleshooting	31
Declaration of conformity	32

### INTENDED USE

The one hand power saw has been exclusively designed for cutting branches. The saw is not intended for continuous commercial use.

The intended use also includes an operation following the operating instructions. In conjunction with the extension handle ,the One hand power saw can be used as a pruner for cutting branches.

Any use beyond these parameters (different media. applying force) or any changes (reconstruction, no original accessory) can lead to serious risks and is regarded as use that is contrary to the intended purpose.

### GENERAL SAFETY WARNINGS

#### WARNING

Read all the safety notes, instructions, illustrations and technical details supplied with this power tool. Failure to follow the safety notices and instructions may result in an electric shock, fire and/or severe injury.

Keep all safety notes and instructions for future reference.

The term “power tool” used in the safety instructions refers to mains-operated power tools (corded) and battery-powered power tools (cordless).

#### Work place safety

1. Keep your work area clean and well lit. Cluttered or dark areas invite accidents.
2. Do not work with the power tool in areas with a risk of explosion where flammable liquids, gases or dusts are present. Power tools create sparks which may ignite the dust or fumes.
3. Keep children and other persons away from the power tool while you are using it. If you are distracted, you could lose control of the power tool.

## GENERAL SAFETY WARNINGS

### Electrical safety

1. The connector plug for the power tool must fit in the socket. The plug must not be modified in any way. Do not use any adapter plugs in combination with power tools with protective earthing. Unmodified plugs and matching outlets will reduce the risk of electric shock.
2. Avoid body contact with earthed surfaces like pipes, heaters, stoves and refrigerators. There is an increased risk of electric shock if your body is earthed or grounded.
3. Keep power tools away from rain or moisture. Water entering a power tool will increase the risk of electric shock.
4. Do not use the cord for improper purposes such as for carrying the power tool, for hanging it up or for pulling or unplugging it from the socket. Keep cord away from heat, oil, sharp edges and moving parts. Damaged or entangled cords increase the risk of electric shock.
5. When operating a power tool outdoors, use only extension cords that are suitable for outdoor use. Use of a cord suitable for outdoor use reduces the risk of electric shock.
6. If operating the power tool in a damp environment cannot be avoided, use a RCD. Use of an RCD reduces the risk of electric shock.

## GENERAL SAFETY WARNINGS

### Safety of persons

1. Be careful, pay attention to what you are doing and approach work with a power tool in a reasonable manner. Do not use any power tool if you are tired or under the influence of drugs, alcohol or medication. A moment of inattention while operating power tools may result in serious personal injury.
2. Wear personal protective gear and always wear safety glasses. Protective equipment such as dust mask, non-skid safety shoes, hard hat, or hearing protection used for appropriate conditions will reduce personal injuries.
3. Avoid accidentally activating the device. Make sure that the power tool is turned off before you connect it to the power supply and/or the rechargeable battery, pick it up or carry it. Carrying power tools with your finger on the switch or connecting the power tool to a power supply while the switch is set to “on” may lead to accidents.
4. Remove all adjusting tools or spanners before you switch the power tool on. A wrench or a key left attached to a rotating part of the power tool may result in personal injury.
5. Avoid an abnormal posture. Keep proper footing and balance at all times. This enables better control of the power tool in unexpected situations.
6. Wear suitable clothing. Do not wear loose clothing or jewellery. Keep your hair and clothing away from moving parts. Loose clothes, jewellery or long hair can be caught in moving parts.

## GENERAL SAFETY WARNINGS

7. If there is an option for installing dust suction devices and dust containers, these should be attached and used correctly. Use of dust collection can reduce dust-related hazards.
8. Do not be lulled into a false sense of security and ignore the safety rules for power tools, even if you are well acquainted with power tools, having used them frequently. Using power tools without due care and attention can cause serious injuries in a split second.

### Using and handling the power tool

1. Do not overload the power tool. Use the right power tool for your work. The correct power tool will do the job better and safer at the rate for which it was designed.
2. Do not use a power tool if its switch is defective. Any power tool that cannot be controlled with the switch is dangerous and must be repaired.
3. Disconnect the plug from the power source and/or remove the rechargeable battery from the power tool before making any adjustments, changing insertion tools or storing the power tool. Such preventive safety measures reduce the risk of starting the power tool accidentally.
4. Keep unused power tools out of the reach of children. Do not let any individual who is not familiar with the power tool or who has not read these instructions operate this power tool. Power tools are dangerous in the hands of untrained users.

## GENERAL SAFETY WARNINGS

5. Maintain power tools and insertion tools with care. Check to make sure that the moving parts are functioning properly and not stuck, whether parts are broken or damaged so as to affect the function of the power tool. If any parts of the power tool are damaged, have them repaired before use. Many accidents are caused by poorly maintained power tools.
6. Keep cutting tools sharp and clean. Properly maintained cutting tools with sharp cutting edges are less likely to bind and are easier to control.
7. Use the power tool and insertion tools, etc., in accordance with these instructions. At the same time, consider the working conditions and the work to be performed. Use of the power tool for operations different from those intended could result in a hazardous situation.
8. Keep handles and handle surfaces dry, clean and free from oil and grease. Slippery handles and handle surfaces will prevent you from operating and controlling the power tools safely in unforeseen situations.

### Cordless tool use and care

1. Only charge the rechargeable batteries with chargers recommended by the manufacturer. Chargers designed for a particular rechargeable battery type pose a risk of fire if used with other types of rechargeable battery.

## GENERAL SAFETY WARNINGS

2. Only use the rechargeable batteries designated for use in power tools. Using other rechargeable batteries may result in injury and a risk of fire.
3. Keep the unused rechargeable battery away from paper clips, coins, keys, nails, screws or other small metallic objects that could bridge the contacts. A short circuit between the contacts of the rechargeable battery could result in burns or fire.
4. If used improperly, liquid may leak out of the rechargeable battery. Avoid coming into contact with it. Rinse with water in the event of accidental contact. If liquid comes into contact with your eyes, also seek medical attention. Fluid leaked from the rechargeable battery may cause skin irritations or burns.
5. Do not use a damaged or modified rechargeable battery. Damaged or modified rechargeable batteries can be unpredictable and may result in fire, an explosion or a risk of injury.
6. Do not expose a rechargeable battery to fire or excessively high temperatures. Fire or temperatures above 130 °C may cause an explosion.
7. Carefully follow all instructions for charging the battery and never charge the battery or cordless tool outside of the temperature range indicated in the instructions. Improper charging or charging outside of the permitted temperature range may damage the battery and increase the risk of fire.

## GENERAL SAFETY WARNINGS

### Service

1. Only have your power tool repaired by a qualified professional and only with original spare parts. This will ensure that the safety of the power tool is maintained.
2. Never perform maintenance on damaged rechargeable batteries. Only the manufacturer or authorised service companies may perform maintenance on rechargeable batteries.

**SAVE THESE INSTRUCTIONS!**

## PRODUCT SAFETY WARNINGS

### Safety instructions for the saw

- Keep all parts of the body away from the saw chain when the saw is operating. Before you start the saw, make sure the saw chain is not contacting anything. A moment of inattention while operating the saw may cause entanglement of your clothing or body with the saw chain.
- Hold the saw by insulated gripping surfaces only, because the saw chain may contact hidden wiring. Saw chains contacting a "live" wire may make exposed metal parts of the saw "live" and could give the operator an electric shock.
- Wear eye protection. Further protective equipment for hearing, head, hands, legs and feet is recommended. Adequate protective equipment will reduce personal injury from flying debris or accidental contact with the saw chain.
- Always keep proper footing and operate the saw only when standing on fixed, secure and level surface. Slippery or unstable surfaces may cause a loss of balance or control of the saw.
- When cutting a limb that is under tension, be alert for spring back. When the tension in the wood fibres is released, the spring-loaded limb may strike the operator and/or throw the saw out of control.
- Use extreme caution when cutting brush and saplings. The slender material may catch the saw chain and be whipped toward you or pull you off balance.

## PRODUCT SAFETY WARNINGS

- Carry the saw by the handle with the saw switched off and away from your body. When transporting or storing the saw, always fit the guide bar cover.
- Proper handling of the saw will reduce the likelihood of accidental contact with the moving saw chain.
- Follow instructions for lubricating, chain tensioning and changing the bar and chain. Improperly tensioned or lubricated chain may either break or increase the chance for kickback.
- Cut wood only. Do not use saw for purposes not intended. For example: do not use saw for cutting metal, plastic, masonry or non-wood building materials. Use of the saw for operations different than intended could result in a hazardous situation.
- This saw is not intended for tree felling. Use of the saw for operations different than intended could result in serious injury to the operator or bystanders.

### Causes and operator prevention of kick-back

- Kick-back may occur when the nose or tip of the guide bar touches an object, or when the wood closes in and pinches the saw chain in the cut.
- Tip contact in some cases may cause a sudden reverse reaction, kicking the guide bar up and back towards the operator.
- Pinching the saw chain along the top of the guide bar may push the guide bar rapidly back towards the operator. Either of these reactions may cause you to lose control of the saw which could result in serious personal injury. Do not rely exclusively upon the



## PRODUCT SAFETY WARNINGS

safety devices built into your saw. As a saw user, you should take several steps to keep your cutting jobs free from accident or injury.

- Kick-back is the result of saw misuse and/or incorrect operating procedures or conditions and can be avoided by taking proper precautions as given below:
  - Maintain a firm grip, with thumb and fingers encircling the saw handle and position your body and arm to allow you to resist kick-back forces. Kick-back forces can be controlled by the operator. If proper precautions are taken. Do not let go of the saw.
  - Only use replacement guide bars and saw chains specified by the manufacturer. Incorrect replacement guide bars and saw chains may cause chain breakage and/or kick-back.
  - Follow the manufacturer's sharpening and maintenance instructions for the saw chain. Decreasing the depth gauge height can lead to increased kick-back.

### **Additional safety instructions for one hand power saw**

- The one hand power saw is designed for cutting branches. Only use the one hand power saw as indicated in this manual for cutting wood. The machine has not been designed for continuous, professional use.
- Keep the one hand power saw out of reach of children. It is not a toy.
- Persons with limited physical, sensorial or mental

## PRODUCT SAFETY WARNINGS

abilities are not allowed to use the One hand power saw, unless they are supervised for their safety by a qualified person or are briefed by the responsible person how to use the machine.

- Children and adolescents are not allowed to use the one hand power saw. Excluded from this prohibition are young people over 16 years of age under the supervision of an expert for the purpose of training.
- Please note the warning symbols. They mark all those instructions which are important for safety reasons. Observe these instructions as failure to do so could result in serious injury!
- The one hand power saw must be used only by one person at a time. Make sure bystanders do not stay in the vicinity of the one hand power saw's work area.
- Check the safe operating condition of the One hand power saw, in particular the guide bar and the saw chain, before each operation.
- Always have a safe stand when working with the saw.
- Hold the machine firmly and securely when switching on.
- Make sure the guide bar and the saw chain must be free when switched on and must not come into contact with the workpiece to be cut.
- Keep your hands away from the sawing area. Do not reach under the workpiece. Contact with the saw chain may result in injury.
- Guide the One hand power saw onto the workpiece only when switched on. Otherwise there is a risk of kick-back if the saw chain gets caught in the work

## PRODUCT SAFETY WARNINGS

piece.

- When sawing, the base plate must always face against the workpiece. The saw chain can become jammed and lead to loss of control over the machine.
- When the cut is completed, switch off the machine and then pull the saw chain out of the cut only after it has come to a standstill. This way you can avoid kick-back.
- Clamp the material to be processed well. Do not support the workpiece with your hand or foot. Do not touch objects or the floor with the saw running. Danger of kick-back.
- When sawing converted timber and thin branches always use a strong support, such as a sawing trestle. Do not stack timber pieces.
- Before cutting logs, secure the logs in position.
- When working on sloping ground, make sure to work facing upwards.
- Be particularly careful when cutting splintered wood. Splinters of wood can be torn along by the saw chain and increase the risk of injury!
- Foreign objects such as nails, screws, metal parts, sand, etc. lead to increased wear on the guide bar and saw chain.
- A blunt saw chain can cause overheating and damage to the motor.
- Always pull out the battery when checking the chain tension, to re-tighten it, to mount the saw chain and to eliminate faults! Also remove the battery if you do not use the machine temporarily.

## SYMBOLS

### Safety symbols

The purpose of safety symbols is to attract your attention to possible dangers. The safety symbols and the explanations with them require your careful attention and full understanding. The symbol warnings do not, by themselves, eliminate any danger. The instructions and warnings they give are no substitutes for proper accident prevention measures.

**WARNING:** Be sure to read and understand all safety instructions in this operator's manual, including all safety alert symbols such as "**DANGER**," "**WARNING**," and "**CAUTION**" before using this tool. Failure to follow all instructions listed below may result in electric shock, fire and/or serious personal injury.

**SAFETY ALERT SYMBOL:** Indicates **DANGER**, **WARNING**, or **CAUTION**. May be used in conjunction with other symbols or pictographs.

### Symbol meaning

This page depicts and describes safety symbols that may appear on this product. Read, understand and follow all instructions on the machine before attempting to assemble and operate.

## SYMBOLS



Read the instructions for use before use!



Wear suitable protective gloves.



Wear protective goggles.



Wear a dust mask.



Always wear hearing protection. The effects of noise can cause hearing loss.



WEEE symbol. Waste electrical products should not be disposed of with household waste. Please recycle where facilities exist. Check with your Local Authority or local store for recycling advice.



The product complies with the applicable European directives and an evaluation method of conformity for these directives was done.



A product placed on the United Kingdom market meets the UKCA Marking requirements



Beware Of kick-back



Do not expose to rain or water

## SYMBOLS

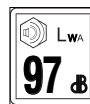

Guaranteed sound power level value is 97 dB.

### Warning symbols on the battery pack



To reduce the risk of injury, user must read the instruction manual carefully.



Do not throw into water.



Do not throw to fire.



Do not subject the battery to strong sunlight over long periods of time. Do not leave on a heater (max.45°C).



Batteries contain Li-ion. Do not dispose of waste batteries in domestic waste. Contact local authority to find out how to dispose of batteries.



WEEE symbol. Waste electrical products should not be disposed of with household waste. Please recycle where facilities exist. Check with your Local Authority or local store for recycling advice.

## SYMBOLS

### Warning symbols on the charger



To reduce the risk of injury, user must read the instruction manual carefully.



The charger is for indoor use only.



Double insulation



WEEE symbol. Waste electrical products should not be disposed of with household waste. Please recycle where facilities exist. Check with your Local Authority or local store for recycling advice.



The product complies with the applicable European directives and an evaluation method of conformity for these directives was done.

T3.15A

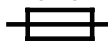



Protective 3.15 A limited



A product placed on the United Kingdom market meets the UKCA Marking requirements

## TECHNICAL DATA

Model		LS C13
Mains voltage		20 V $\text{AC}$
No load chain speed		3,2 m/s
Cutting diameter. Max.		110 mm
Sound pressure level: $L_{pA}$		83.1 dB(A)
Sound power level: $L_{wA}$		94.1 dB(A)
Vibration front handle		2,045 $\text{m/s}^2$
Weight:		1,64 kg
Battery pack model		B0P-SP07-20ZN
Capacity		20 V $\text{AC}$ , 2,0 Ah
Charger model		VDE: B0Q-SP06-20ZA BS: B0Q-SP06-20ZB
Input		230–240 V~, 50/60 Hz
Output:		21 V $\text{AC}$ , 2,4 A

The vibration emission level stated in this instruction manual has been measured in accordance with a standardized test given in EN 60745; it may be used to vibration when using the tool for the applications mentioned.

- using the tool for different applications, or with different or poorly maintained accessories, may significantly increase the exposure level
- the times when the tool is switched off or when it is running but not actually doing the job, may significantly reduce the exposure level.

Protect yourself against the effects of vibration by maintaining the tool and its accessories, keeping your hands warm, and organizing your work patterns.

## DESCRIPTION OF PRODUCT

### Parts description (Fig. A)

1. Guide bar
2. Saw chain
3. Chain drive cover locking knob
4. On/Off switch
5. Hand Protection guard
6. battery pack
7. Handle grip
8. Saftey lock button
9. Chain drive cover
10. Chain safety guard

### Delivery contents (Fig. B)

Carefully unpack the appliance and check that it is complete. Dispose of the packaging material correctly.

- a. Chain cover guard
- b. 20V one hand power saw
- c. Allen key
- d. Lubricating oil
- e. Battery pack
- f. Charger
- g. Instruction manual



**WARNING:** If any parts are damaged or missing, do not operate this tool until these parts are replaced. Failure to heed this warning could result in serious personal injury.



**NOTE:** Always recycle the packaging in accordance with local recycling guidelines.

## OPERATION

### Remove the Chain cover guard (Fig. C)

#### Charging the battery pack

**NOTE:** Remove the battery pack from the charger after it has been fully charged.

**NOTE:** Battery should be fully charged before first use.

**NOTE:** Make sure the mains voltage is the same as rating label which is located on the charger.

1. Connect the charger to a power supply. Red LED will light up.
2. To insert the battery pack into the charger, align the raised ribs of the battery pack with the grooves of the charger then push it in. (Fig. D)
3. The red LED light of the charger will light up and then the green light flashes during normal charging.
4. After charging is complete, the charger light will turn to a solid green light.
5. Once the battery is fully charged, depress the battery release button and then remove the battery pack. (Fig. D)

#### Power indicator (Fig. E)

This Li-Ion battery pack is equipped with a power indicator which is used to show the battery pack's remaining charge. Press the power indicator button to check battery charge as picture showed. The indicator will stay lit for approximately 4 seconds.

#### To obtain the best life from the battery

1. Never allow the battery to completely discharge before recharging. The battery pack should be placed on the charger whenever the battery pack is noticeably running down or the tool no longer performs a task it previously performed.
2. Avoid conducting short charges. Make sure that the battery is fully charged each time by allowing the charger to complete its full charging cycle.
3. Avoid allowing loose items like screws or nails etc. to be stored with battery packs as these or similar items can short battery packs and cause a fire or explosion.
4. Always unplug the charger when not in use and store in a dry and secure place.
5. Avoid charging or storing your battery in temperatures below 5°C and above 45°C.
6. After use, allow the battery pack to cool down for approximately 30 minutes before attempting to recharge.

#### To insert the battery pack (Fig. F)

1. Align the groove on the battery pack with the corresponding ribs in the receptacle of the device.
2. Insert the battery pack with moderate force until it was locks in to place.

**WARNING: Only use Yard force 20V original battery pack!**

## OPERATION

### To remove the battery pack from the tool (Fig. G)

1. Press the battery pack release button.
2. Remove the battery pack from the tool.

### Check before starting!

**DANGER!** Risk of injury! The device must only be put into operation if no faults are found. If any part of the device is defective, it must be replaced before the next use.

Check the safety equipment and the safe condition of the device.

- Check all parts to make sure they fit tightly.
- Check whether there are visible defects: broken parts, cracks, etc.

### Switching ON and OFF (Fig. H)

The use of the one hand power saw without lubricating the chain with chain oil will damage the saw chain and the guide bar.

1. Hold the one hand power saw firmly and securely by the handgrip. To switch on the machine, first press the safety switch and then press the ON/OFF switch.
2. To switch off the saw, release the ON/ OFF switch.

### Break-in time for new saw chains

1. Remove the battery and adjust the chain tension.
  2. Switch on the machine and leave the motor running idle for approx. 5 minutes.
  3. Remove the battery and check the chain tension again. If necessary, retighten the chain.
  4. Afterwards make only easy cuts for approx. 30 minutes. Always ensure sufficient lubrication of the saw chain! Only use the one hand power saw for heavier cuts and greater cutting depths after the running-in period has expired.
- Use only sharp saw chains. Blunt saw chains can jam more easily. Check the chain tension more frequently when working with new saw chains, as the chain stretches more at first.
  - The service life of a saw chain depends on sufficient lubrication and the correct tension.
  - During operation, the chain heats up and re-tensioning may be necessary. Relax the chain after work so that it is not too tight the next time the cold machine is used.
  - Do not re-tighten saw chains that have become too hot. After it has cooled down, it may contract and lie too tight against the sword. Wait until the saw chain has cooled down before re-tensioning.
  - The tension of the saw chain is important for your safety and the function of the machine. A correctly tensioned saw chain increases the service life of the machine.
  - Check the chain tension before each use.
  - The saw chain is correctly tensioned if it can be pulled around the sword by hand (wear protective gloves) without sagging.
  - With new saw chains, you must readjust the chain tension again after a short period of operation.

## OPERATION

### Work instructions

- Never reach over the riving knife or under the base plate. There is a risk of injury!
- Do not cut if the saw chain is in contact with the workpiece, is in the workpiece or may hit an object. This can lead to serious injuries.
- Clamp loose workpieces before cutting them. Remove foreign objects such as nails, screws, etc.
- When cutting a branch that is under tension be alert for spring back. When the tension in the wood fibres is released, the spring-loaded limb may strike the operator and/or throw the machine out of control.
- Use extreme caution when cutting brush and saplings. The slender material may catch the saw chain and be whipped toward you or pull you off balance.
- When the saw chain is running. First place the base plate on the surface of the workpiece and let the saw cut on its own. Apply only light pressure to the saw. The chain speed should not be much slower.

### Re-mounting the saw chain

#### Risk of injury!

Always wear gloves when handling the saw chain.

1. Unscrew the head screw counter-clockwise in order to remove the sprocket cover. **(Fig. I)**
2. Run the saw chain over the sprocket. Please note the running direction of the saw chain. The saw chain icon is shown on the cover. **(Fig. J&K)**
3. Tighten the saw chain with the chain drive cover locking knob. For tightening, turn the screw clockwise. **(Fig. L)**
4. Firmly tighten the saw chain with the chain adjusting screw. Use the included adjustment key to tighten the screw. **(Fig. M&N)**

### Chain lubricating oil (Fig. O)

- Only use commercially available, biodegradable chain oils that are specially designed for use in multi saws.
- Do not use engine oil, waste oil or other mineral oils.

## OPERATION

### Adjusting saw chain tension

**CAUTION:** Do not tighten the saw chain too much. Excessively high tension of saw chain may cause breakage of saw chain, wear of the guide bar and breakage of the sprocket.

**CAUTION:** A chain which is too loose can jump off the guide bar.

The saw chain may become loose after many hours of use. From time to time check the saw chain tension before use.

1. Remove the battery.
2. Loosen the head screw a bit to loosen the sprocket cover lightly.
3. Adjust the chain tension. Turn the chain head screw clockwise to tighten, turn it counter-clockwise to loosen. Tighten the saw chain so that the gap between the centre of the lower side of the guide bar and the saw chain becomes approximately 3 – 4 mm.
4. Tighten the head screw to secure the sprocket cover.

### Kick-back

- The shape of the riving knife largely eliminates the risk of kick-back.
- The saw is optimally protected against kick-back by the riving knife With tip protection. Never remove the riving knife. There is a risk of injury!

### Sharpen the saw chain

- The saw teeth must be sharpened if the sawdust becomes powdery, if additional force is required for the incision, if a straight incision is no longer possible or if the vibrations become stronger.
- Blunt saw chains should be re-sharpened.
- To sharpen the chain use a chain sharpener. make sure you sharpen the chain at a 30° angle.
- Or have the chain re-sharpened professionally (advised).
- Replace the saw chain if there is considerable damage that cannot be repaired by filing.

### Cleaning the guide bar

- Thoroughly clean the notch of the guide bar.
- Replace the guide bar if the guide groove is damaged or worn and the saw chain has too much lateral space.
- Tighten all accessible screws, if necessary.

## MAINTENANCE AND STORAGE

### Cleaning and maintenance

#### Risk of injury!

Improperly handling the saw may result in injury.

- Remove the rechargeable battery from the saw before beginning work on the saw.
- Let the saw cool off completely before performing work on the saw.
- Remove the saw blade before performing work on the saw and wear protective gloves to prevent cut injuries.
- Wear protective goggles when cleaning.
- After performing any cleaning and maintenance work, mount all protective devices, to the extent present, properly and safely. Never use the saw without protective devices.

#### Risk of short circuit!

Water that has penetrated the housing may cause a short circuit.

- Never submerge the saw in water or other liquids.
- Make sure that no water or other liquids penetrate the housing.

#### Risk of damage!

Improperly cleaning may lead to damage.

- Do not use any aggressive cleaners, brushes with metal or nylon bristles or sharp or metallic cleaning utensils such as knives, hard scrapers and the like. They could damage the surfaces.
- Never use a solvent to clean plastic parts.

### Cleaning the saw

- Use a soft cloth or brush to clean the housing.
- Use a soft brush to remove any dust that has collected from the device openings.
- Remove dust or chips by blowing them out with compressed air.

### Maintaining the saw

- Keep the saw and the vents clean to ensure proper, safe work.
- Check regularly whether dust or foreign bodies have entered the saw near to the motor and around the power switch.
- Regularly lubricate all moving parts.
- Before and after each use, check the saw and accessories (e.g. saw blades) for wear and damage. Replace any accessory parts if necessary. Observe the technical requirements in the process.
- Regularly check all fixtures. They could come loose over time due to vibration.
- If you identify any damage, you must have it repaired by a specialist workshop to prevent risks.

## MAINTENANCE AND STORAGE

### Repairs

There are no parts that can be repaired by the user inside the saw. If you identify damage, contact a specialist workshop or qualified personnel. Repairs performed by the user and opening the housing void your warranty claim.

If the mains cord of the charger is damaged, it must be replaced by a special network cable which can be obtained from the manufacturer or the manufacturer's customer service department. The mains cord may only be replaced by a specialist workshop or qualified specialist personnel.

### Storage

- Remove the rechargeable battery from the saw.
- Clean the saw before storing it.
- Store the saw and accessories in a dry, frost-free place. The perfect storage temperature ranges from 10 to 30 °C.
- If possible, store the saw in the transportation case.
- Always store the saw out of the reach of children.
- Check the saw for possible signs of wear and damages before using it again.
- If a lithium ion battery has been stored over a longer period, the charge level must be regularly checked.

### Transport

#### Risk of injury!

Incorrect transport may result in cut injuries.

- Remove the battery pack before transport. Proceed as follows:
- Switch the saw off and remove the battery from the saw before transporting it.
- Always carry the saw using the handle.
- Secure the saw against slipping and tilting. If necessary, mount transport guards.
- Protect the saw against damage and intense vibrations, which could occur particularly when transporting it in vehicles.

### Disposal

Do not dispose of electric power tools with domestic refuse.

The electric power tool is shipped in packaging to reduce transport damage. This packaging is a raw material and as such can either be reused or can be fed back into the raw material cycle. The electric power tool and its accessories are made from various materials such as metals and plastics. Take defective components to a special refuse collection point. Ask about these at your specialist shop or local council.

#### Batteries

Think of the environment when disposing of batteries. Contact your local authorities to find out where your nearest disposal area is. Do not dispose of batteries with domestic refuse. Do not dispose of by burning. risk of explosion.

## MAINTENANCE AND STORAGE



**WARNING:** Before performing any repair work, always ensure that the battery pack has been removed.



**WARNING:** Always wear heavy duty gloves when adjusting or cleaning, especially when handling sharp objects.

Fault/malfunction	Cause	Remedy
Product does not start	Battery pack not properly attached	Attach properly
	Battery pack discharged	Remove and charge the battery pack
	Battery pack damaged	Contact our service centre
	Other electrical defect to the product	Contact our service centre
Product does not reach full power	Battery pack capacity too low	Remove and charge the battery pack
	Air vents are blocked	Clean the air vents
Poor cutting performance	Accessory is worn	Replace with a new one
	Accessory not suitable for intended operation	Use suitable accessory
Product suddenly stops	Product overloaded	Remove the product from the workpiece and switch it on again
	Battery pack discharged	Remove and charge the battery pack
	Battery pack too hot	Remove the battery pack and let it cool down
Excessive vibration or noise	Accessory is dull / damaged	Replace with a new one
	Side cover / chain loose	Adjust the chain and retighten side cover lock knob



## DECLARATION OF CONFORMITY

To the provisions of Council Directives

We  
MEROTEC GmbH  
Otto-Brenner-Str. 8, 47877 Willich, Germany

Declare that the product:  
Description: 20V Pruning saw  
Model No. LS C13  
Function: cutting wood

**Complies with the essential health and safety requirements of the following directives:**

Machinery Directive 2006/42/EC  
Low Voltage Directive 2014/35/EU  
Electromagnetic Compatibility Directive 2014/30/EU  
EC Directive 2011/65/EU and its amendment Directive (EU) 2015/863 (RoHS)

**Standards and technical specification referred to:**

EN 62841-1:2015  
EN ISO 12100:2010  
EN 60335-1:2012+A11+A13+A1+A14+A2  
EN 60335-2-29:2004+A2+A11  
EN 62233:2008  
EN 55014-1:2017+A11:2020  
EN 55014-2:2015  
EN 61000-3-2:2014  
EN 61000-3-3:2013

Authorized Signatory  
Date: 18.07.2021

Signature:   
Place: Willich  
Name: Ronald Menken  
General Manager

MEROTEC GmbH  
Otto-Brenner-Str. 8  
D-47877 Willich



## DECLARATION OF CONFORMITY

To the provisions of Council Directives

We  
SUMEC UK  
Unit A&B Escrick Business Park Escrick, York YO19 6FD  
United Kingdom

Declare that the product:  
Description: 20V Pruning saw  
Model No. LS C13  
Function: cutting wood

**Complies with the essential health and safety requirements of the following directives:**

Supply of Machinery (Safety) Regulations 2008  
Electrical Equipment (Safety) Regulations 2016  
The Restriction of the Use of Certain Hazardous Substances in Electrical and Electronic Equipment Regulations 2012

**Standards and technical specification referred to:**

EN 62841-1:2015  
EN ISO 12100:2010  
EN 60335-1:2012+A11+A13+A1+A14+A2  
EN 60335-2-29:2004+A2+A11  
EN 62233:2008  
EN 55014-1:2017+A11:2020  
EN 55014-2:2015  
EN 61000-3-2:2014  
EN 61000-3-3:2013

Authorized Signatory  
Date: 18.07.2021

Signature:   
Place: York  
Name: Mariana Hall  
General Manager

SUMEC UK Co.,Ltd.  
Unit A&B Escrick Business Park  
Escrick, York YO19 6FD  
United Kingdom

