



**SPEAR &
JACKSON**

ORIGINAL INSTRUCTION MANUAL

44cm 36V

Cordless Mower

SCR3644A



V2: 06/21

**Important - Please read these instructions
fully before starting assembly**

These instructions contain important information that will help you get the best from your mower, ensuring it is assembled correctly and safely. If you need help or have damaged or missing parts, call the Customer Helpline on 0345 605 2067

**AFTER SALES SUPPORT
0345 605 2067**

SAN NO.: 0321801944ZF

SPEAR & JACKSON SINCE 1760

For more than 250 years gardeners have enjoyed high quality performance and great results using Spear & Jackson tools.

Our garden power tools combine continuous innovation and the latest in manufacturing technologies with a proud heritage.

Each product is carefully designed with performance, comfort and durability firmly in mind, which has earned Spear & Jackson an enviable reputation as a maker of tools to trust.

3 YEAR GUARANTEE

As a testament to the quality of our products, we offer a 3 year manufacturers warranty and a comprehensive after sales service.

The warranty covers manufacturing faults, however in the event that the item has been deliberately damaged, used in a commercial environment or disassembled then the warranty will be null and void.

Please retain proof of purchase.

7 DAYS A WEEK TECHNICAL SUPPORT

We want you to get the best out of our products. Our easy-to-read instruction manual guides you with best practice use and maintenance tips. Please call **0345 605 2067** for technical support, we can solve around 80% of questions directly over the phone.

We hope you enjoy your product and we look forward to any feedback, as this allows us to develop even better products in the future.

Produced in China under licence for Spear & Jackson.

Argos Limited 489-499 Ave-bury Boulevard, Milton Keynes, MK9 2NW.

Argos (N.I.) Ltd, Forestside Shopping Centre, Upper Galwally, Belfast, United Kingdom, BT8 6FX.

Argos Distributors (Ireland) Limited, Unit 7, Ashbourne Retail Park, Ballybin Road, Ash-bourne, County Meath, Ireland.

CONTENTS

Safety Information	04
Description of symbols.....	04
General safety.....	06
Operating safety.....	06
Maintenance and storage safety.....	13
Intended use.....	16
Box Contents	17
Assembly	18
Unpacking.....	18
Handle assembly	18
Fixing the cable	19
Assembling the grass bag	19
Operation	20
Charging the battery pack.....	20
Power indicator.....	21
Low capacity warning.....	21
Battery life	22
Mower operation	22
Battery pack removal	24
Mowing tips.....	24
Mowing direction	25
Grass bag full indicator	25
Maintenance	26
Technical Data	29
Troubleshooting	31
Warranty	32

SAFETY INFORMATION

Please read these instructions fully before operating or maintaining your machine.

DESCRIPTION OF SYMBOLS

The following warning symbols appear throughout this manual and indicate the appropriate safety measures you should take when operating and maintaining your lawnmower.

WARNING SYMBOLS ON THE TOOL



To reduce the risk of injury, user must read instruction manual carefully.



Keep bystanders away. Objects thrown by the product could hit the user or bystanders. Always ensure that other people and pets remain at a safe distance from the product when it is in operation.



Guaranteed sound power level value is 96 dB.



WEEE symbol. Waste electrical products should not be disposed of with household waste. Please recycle where facilities exist. Check with your local authority or local store for recycling guidelines.



Do not use mower without grass catcher or guard in place.



Disconnect battery before maintenance.



Avoid using tool in the rain. Wait until all machine components have come to a complete stop before touching them.



Beware of sharp blades. Blades continue to rotate after the motor is switched off. Remove disabling device before performing any maintenance tasks.



Wear ear protection.
Wear eye protection
Wear protective gloves.



Conforms to relevant EU regulatory requirements



Conforms to relevant UK regulatory requirements

SAFETY INFORMATION

Please read these instructions fully before operating or maintaining your machine.

WARNING SYMBOLS ON THE BATTERY PACK



Do not throw into water.



Do not throw on fire.



Do not subject the battery to strong sunlight over long periods of time. Do not leave in an area with a temperature higher than 45 °C.



Batteries contain Li-ion. Do not dispose of waste batteries in domestic waste. Contact local authority to find out how to dispose of batteries appropriately.



To reduce the risk of injury, user must read instruction manual carefully.

WARNING SYMBOLS ON THE CHARGER



Only for indoor use.



Double insulation.



Protective 4A limited



WEEE symbol. Waste electrical products should not be disposed of with household waste. Please recycle where facilities exist. Check with your Local Authority or local store for recycling advice.



To reduce the risk of injury, user must read instruction manual carefully.



Conforms to relevant EU regulatory requirements





Conforms to relevant UK regulatory requirements

SAFETY INFORMATION

Please read these instructions fully before operating or maintaining your machine

GENERAL SAFETY

 **WARNING!** These instructions are for your safety. Ensure that you have read and understood these instructions before using the machine. Keep these instructions in a safe place for future reference.

 **WARNING!** Read all safety warnings and instructions. Failure to follow the warnings and instructions may result in electric shock, fire and/or serious injury. Carefully read the instructions for the safe operation of the machine. Save all warnings and instructions for future reference.

■ This appliance can be used by children aged from 8 years and above and persons with reduced physical, sensory or

mental capabilities or lack of experience and knowledge if they have been given supervision or instruction concerning use of the appliance in a safe way and understand the hazards involved.

- Local regulations can restrict the age of the operator.
- Children should be supervised to ensure that they do not play with the appliance.

OPERATING SAFETY

IMPORTANT

READ CAREFULLY BEFORE USE
KEEP FOR FUTURE REFERENCE

TRAINING

- Read the instructions carefully and make sure you fully understand them. Make sure you are familiar with the controls and the correct use of the product.

SAFETY INFORMATION

Please read these instructions fully before operating or maintaining your machine

- Never allow children or people unfamiliar with these instructions to use the product. Local regulations can restrict the age of the operator.
- Never operate the product while people, especially children or pets are nearby.
- Keep in mind that the operator or user is responsible for any accidents or hazards occurring to other people or their property.

PREPARATION

- While operating the product always wear substantial footwear and long trousers. Do not operate this product when barefoot or wearing open sandals. Avoid wearing clothing that is loose fitting or has hanging cords or ties.

- Thoroughly inspect the area where the product is to be used and remove all objects which could be thrown by the product.
- Before use, always visually inspect to see that the blade, blade bolt and the blade assembly are not worn or damaged. Replace worn or damaged components in sets to preserve balance. Replace any damaged or unreadable labels.
- Ensure the switch is in the off position before inserting the battery pack. Inserting the battery pack into a machine that is switched on can result in injury.

OPERATION

- Use the tool only with specifically designated battery packs. Use of any other battery packs will increase the risk of injury and fire.

SAFETY INFORMATION

Please read these instructions fully before operating or maintaining your machine

- Only operate the product in daylight or in good artificial light.
- Do not expose tool and charger to rain or wet conditions. If a tool or charger is exposed to moisture this will increase the risk of electric shock.
- Avoid operating the product on wet grass.
- Always be sure of your footing on slopes.
- Walk, never run.
- Mow across the face of slopes, never up and down.
- Exercise extreme caution when changing direction on slopes.
- Do not mow excessively steep slopes.
- Use extreme caution when reversing or pulling the product towards you.
- Stop the blades if the product has to be tilted for transportation, when crossing surfaces other than grass and when transporting the product to and from the area to be mowed.
- Never operate the product with defective guards or shields or without safety devices in place such as deflectors or grass collector.
- When switching on motor keep feet well away from blades.
- Do not tilt the product when switching on the motor, except if the product has to be tilted for starting. In this case, do not tilt it more than absolutely necessary and lift only the part furthest away from the operator.
- Do not start the product when standing in front of the discharge opening.
- Do not put hands or feet near or under rotating parts.



SAFETY INFORMATION

Please read these instructions fully before operating or maintaining your machine

- Keep clear of the discharge opening at all times.
- Do not transport the product while the cutting blade is running.
- Stop the product and remove the key/battery pack from the machine and make sure that all moving parts have come to a complete stop:
 - Whenever the product is left unattended.
 - Before clearing blockages or unclogging chute.
 - Before checking, cleaning or working on the product.
 - After striking a foreign object. Make sure to inspect the product for damage and make repairs before restarting the product.
- If the product starts to vibrate abnormally:

- Inspect for any damages.
- Replace or repair any damaged parts.
- Check for and tighten any loose parts.

GENERAL SAFETY WARNINGS FOR YOUR BATTERY CHARGER

-  **WARNING!** Cleaning and user maintenance shall not be made by children without supervision.
-  **WARNING!** Do not recharge non-rechargeable batteries, as they can overheat and break.

CHARGING

- Recharge only with the charger specified by the manufacturer. Do not use the original charger on other li-ion batteries or on

SAFETY INFORMATION

Please read these instructions fully before operating or maintaining your machine

any other type of battery as this will increase the risk of fire or explosion.

- Check the battery charger, cable and plug before each use. Do not use the battery charger if damaged. Do not open the battery charger yourself; charger must be repaired by qualified personnel using original spare parts.
- The charger is designed to use a standard household 220-240 V~ 50Hz power source, always ensure that the plug matches the outlet.
- Never modify the plug in any way, this will increase the risk of electric shock.
- Do not abuse the cord of charger. Never use the cord for carrying, pulling or unplugging the charger. Keep cord away from heat, oil, sharp edges or moving parts. Damaged or entangled cords increases

the risk of electric shock.

- Make sure the charger cord is positioned so that it will not be stepped on, tripped over or get damaged.
- Keep the battery charger clean. Contamination can increase the risk of electric shock.
- Protect the battery charger from rain and moisture. If water accesses the battery charger there is an increased risk of electric shock.
- Battery will heat up whilst charging. To reduce the risk of fire, do not operate battery charger on flammable surfaces such as paper or textiles.
- The temperature range over which the battery pack can be charged is typically between 5°C - 45 °C. Attempt to charge the battery outwith the prescribed temperature range may automatically

SAFETY INFORMATION

Please read these instructions fully before operating or maintaining your machine

be blocked by the protection circuitry of the battery pack. Longest life and best performance can be obtained if the battery pack is charged at room temperature.

- Disconnect charger from the power supply when not in use. This will reduce the risk of electric shock or damage to the charger.

GENERAL SAFETY WARNINGS FOR BATTERY PACK

- Do not dismantle, open or shred secondary cells or batteries.
- Keep batteries out of the reach of children
- Do not expose cells or batteries to heat or fire. Avoid storage in direct sunlight.
- Do not short-circuit a cell or a battery.
- Do not store cells or batteries haphazardly in

an area where they may short-circuit each other or be short-circuited by other metal objects. Do not carry individual battery packs in your pockets or bag as they could short-circuit against other metal items.

- Do not remove a cell or battery from its original packaging until required for use.
- Do not subject cells or batteries to mechanical shock.
- In the event of a cell leaking, do not allow the liquid to come in contact with the skin or eyes. If contact has been made, wash the affected area with copious amounts of water and seek medical advice.
- Do not use any charger other than that specifically provided for use with the equipment.

SAFETY INFORMATION

Please read these instructions fully before operating or maintaining your machine

- Observe the plus (+) and minus (–) marks on the cell, battery and equipment.
- Do not use any battery which is not designed for use with the equipment.
- Do not mix cells of different manufacture, capacity, size or type within a device.
- Battery usage by children should be supervised.
- Seek medical advice immediately if a cell or a battery has been swallowed.
- Always purchase the battery recommended by the device manufacturer for the equipment.
- Keep batteries clean and dry.
- Wipe the cell or battery terminals with a clean dry cloth if they become dirty.
- Secondary batteries need to be charged before use. Always use the correct charger and refer to the manufacturer's instructions or equipment manual for proper charging instructions.
- Do not leave a battery on prolonged charge when not in use.
- After extended periods of storage, it may be necessary to charge and discharge the batteries several times to obtain maximum performance.
- Retain the original product literature for future reference.
- Use the cell or battery only in the application for which it was intended.
- When possible, remove the battery from the equipment when not in use.
- Dispose of properly.
- Should a li-ion battery catch fire, ensure to use the correct fire extinguisher to combat the fire. DO

SAFETY INFORMATION

Please read these instructions fully before operating or maintaining your machine

MAINTENANCE AND STORAGE SAFETY

NOT THROW WATER ON A BURNING LI-ION BATTERY.

- If the battery pack becomes too hot during charging, disconnect and switch off immediately. Contact the service centre directly.
- Recharge battery pack immediately when the power output starts to slow. **DO NOT CONTINUE TO USE PRODUCT WHEN BATTERY LEVEL IS LOW.**
- To prevent serious damage to the battery, charge in temperatures above 5°C or below 45°C. Longest life and best performance can be achieved when battery is charged at room temperature.
- Remove the battery-pack and safety key before carrying out maintenance or cleaning work.
- Keep all nuts, bolts and screws tight to be sure the product is in a safe working condition.
- Use only the manufacturer's recommended replacement parts and accessories.
- Inspect and maintain the machine regularly. Machine repairs should only be undertaken by authorised personnel. Check the grass collector frequently for wear or deterioration.
- Be careful when adjusting the product to prevent trapping fingers between moving blades or other fixed parts of the product.
- Always allow the product to cool down before storing.

SAFETY INFORMATION

Please read these instructions fully before operating or maintaining your machine

- When servicing the blades be aware that even though the power source is switched off, the blades can still move.
- Replace worn or damaged parts for safety. Use only genuine replacement parts and accessories.
- DO NOT attempt to open the charger and battery pack. There are no customer serviceable parts inside. Return to any authorised service centre.
- Store the appliance with battery pack fully charged at room temperature (around 20°C).
- Every deep discharge cycle decreases the capacity of battery pack. To prolong battery life, it is recommended that you charge the battery every six months within extended periods of time when the product is not in use.

- When not in use, store the machine out of the reach of children.

SERVICING

- Have your tool repaired by an authorised service agent. This tool is manufactured in accordance with the relevant safety regulations. To avoid danger, equipment must only be repaired by qualified technicians.
- Only use parts and accessories made for this machine by the manufacturer. Failure to do so can result in personal injury.

SAFETY INFORMATION

Please read these instructions fully before operating or maintaining your machine

EMERGENCY

 **WARNING!** Ensure you read, understand and follow the safety directives in this manual. This will help to prevent hazards and risks to the operator and their surroundings.

- Be alert when using the machine, this will allow you to recognise and handle risks early. Fast intervention can prevent serious injury and damage to property.
- Disconnect the product from the power supply in the event of a malfunction. Have the machine inspected by a qualified person before restarting the machine.

RESIDUAL RISKS

 **WARNING!** Even if you are operating the machine in accordance with all safety requirements, potential risks of injury and damage remain. The following dangers can arise in connection with the structure and design of this machine:

- Health defects resulting from vibration emission if the machine is being used over long periods of time or not adequately managed and properly maintained.
- Injuries and damage to property due to broken application tools or sudden impact of hidden objects during use.
- Danger of injury and property damage caused by flying objects. Do not abuse the cord. Never use the cord for carrying, pulling or unplugging the machine. Keep the cord

SAFETY INFORMATION

Please read these instructions fully before operating or maintaining your machine

away from heat, oil, sharp edges or moving parts. Damaged or entangled cords increase the risk of electric shock.



WARNING! This machine produces an electromagnetic field during operation! This field may, under some circumstances, interfere with active or passive medical implants. To reduce the risk of serious or fatal injury, we recommend persons with medical implants to consult their doctor and medical implant manufacturer before operating this product!

INTENDED USE

- This lawnmower has been designed for cutting grass. The machine is to be used only for its prescribed purpose, any other use is deemed to be a case of misuse.
- Please note that our equipment has not been designed for use in commercial, trade or industrial applications. Our warranty will be voided if the machine is used in commercial, trade or industrial businesses or for equivalent purposes.

BOX CONTENTS

PARTS

- | | | | |
|---|--|----|--|
| 1 | Switch box | 10 | Deck |
| 2 | Switch bar | 11 | Quick release lock for lower handle
2 pcs |
| 3 | Upper handle | 12 | Roller |
| 4 | Lower handle | 13 | Grass bag handle |
| 5 | Quick release lock for upper handle
2 pcs | 14 | Battery pack 2pcs |
| 6 | Grass full indicator | 15 | Charger |
| 7 | Grass bag | 16 | Rear guard |
| 8 | Wheel | 17 | Safety key |
| 9 | Height adjustment handle | 18 | Mulching plug |

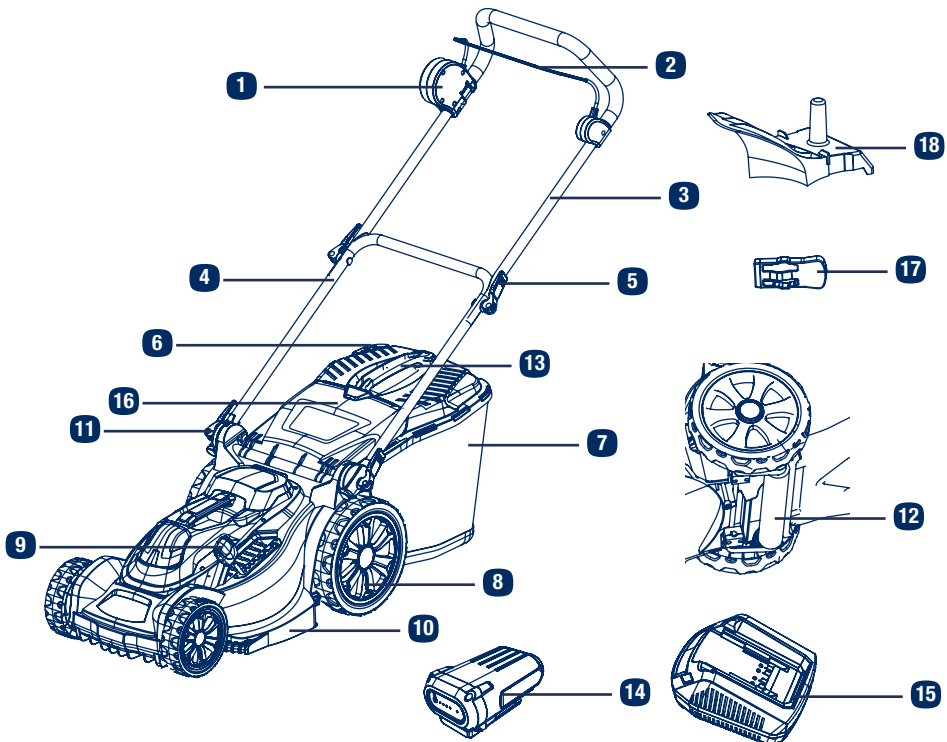

If there are any parts missing, please call the customer helpline on **0345 605 2067**

1 Unpacking

- i. Unpack all parts and lay them on a flat, stable surface.
 - ii. Remove all packing materials and shipping devices if applicable.
 - iii. Make sure the delivery contents are complete and free of any damage. If you find that parts are missing or show signs of damage do not use the product but contact the aftersales service within 28 days of purchase. Using an incomplete or damaged product represents a hazard to people and property.
 - iv. Ensure that you have all the accessories and tools needed for assembly and operation. This also includes suitable personal protective equipment.
-

2 Handle assembly

- i. Slide the two fixing blocks to the end of the lower handle.
- ii. Insert the quick release lock into the tube and handle seat. Screw the bolt in and clamp it to fix the lower handle.
- iii. Fit the upper handle and lower handle together with the quick release lock system. You can rotate the release lock to adjust its tightness.

ASSEMBLY

3 Fixing the cable

- i. Ensure that the cables clips supplied are used to fix the cable to the handle.

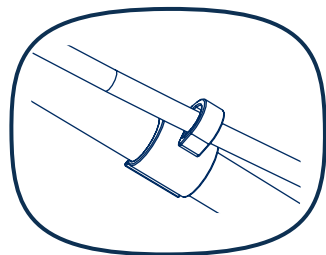

4 Assembling the grass bag

- i. Place the metal frame inside the grass collection bag. Make sure that these clips are fully secured to the metal frame.

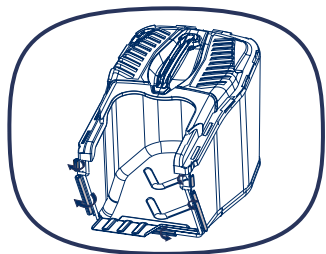

- ii. Remove the mulching plug before attaching the grass bag

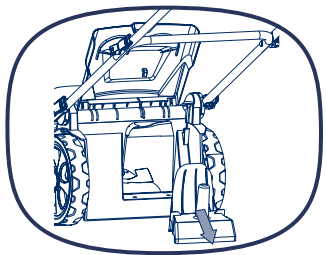

- iii. Lift up the rear flap before assembling the grass bag. Hang the collection bag on the mower.

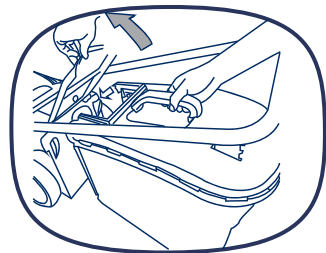

OPERATION

CHARGING THE BATTERY PACK

NOTE: Remove the battery pack from the charger once it is fully charged.

NOTE: Battery should be fully charged before first use.

NOTE: Make sure the mains voltage is the same as rating label which is located on the charger.

1. Connect the charger to a power supply. You should hear a beep and the green LED will light up.
2. To insert the battery pack into the charger, align the raised ribs of the battery pack with the grooves of the charger then push it in.

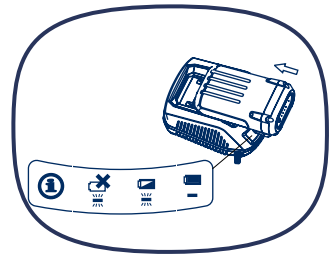

3. You can read the battery pack's remaining charge by using the chart.

	R	G1	G2	G3	G4
Q>95%	○	●	●	●	☀
80%<Q<95%	○	●	●	☀	○
30%<Q<80%	○	●	☀	○	○
Q<30%	○	☀	○	○	○
Q: battery pack, capacity			☀	●	○
			Flash	ON	OFF

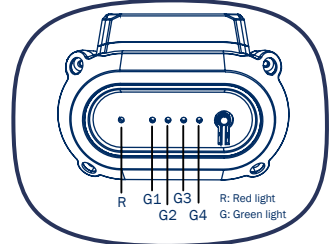

4. The green LED light of the charger will flash continuously during normal charging.
5. After charging is complete, you will hear a beep and the four green lights on the battery pack will light up for roughly 3-5 seconds and then turn off.
6. If you encounter one of the below situations, the charging light will turn red and flash.

The device will also beep until the issue is resolved.

OPERATION

- 1). Poor communication. This refers to poor connection between charger and battery pack.
- 2). Internal temperature of the battery pack is out of working range from 5-45°C.
- 3). Full voltage of the battery pack is less than 32V.
- 4). Short circuit of the output or battery pack is overloaded.

POWER INDICATOR

This Li-Ion battery pack is equipped with a power indicator which is used to show the battery pack's remaining capacity.

1. Push the PRESS button to check on the battery status.
2. The number of lights lit will depend on the condition of the battery. Four lights indicates a fully charged battery, one light indicates the battery needs to be charged.

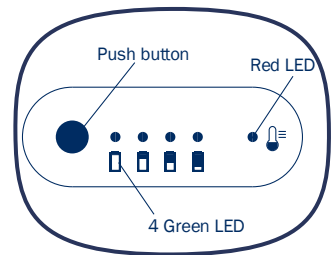

LOW CAPACITY WARNING

Unlike other battery pack types, lithium-ion battery packs deliver fade-free power for their entire run time. The tool will not experience a slow, gradual loss of power as you work. If the red LED  on the battery pack begins to flash, the battery pack's capacity is below 1% capacity and should be recharged.

OPERATION

BATTERY LIFE

Tips for battery life

- Never allow the battery pack to completely discharge. The battery pack should be placed on the charger whenever the battery pack is noticeably running down or the tool no longer performs a task as it previously performed.
- Avoid conducting short charges. Make sure that the battery is fully charged each time by allowing the charger to complete its full charging cycle.
- Avoid allowing loose items like screws or nails etc. to be stored with battery packs as these or similar items can short battery packs and cause a fire or explosion.
- Always unplug the charger when not in use and store in a dry and secure place.
- Avoid charging or storing your battery in temperatures below 5°C and above 45°C.
- After use, allow the battery pack to cool down for approximately 30 minutes before attempting to recharge.

MOWER OPERATION

Switch on:

- i. Insert the battery pack

Align the battery pack with its compartment of the tool.
Push the battery pack into the tank until you hear a click.
This means the battery pack has been locked in position.

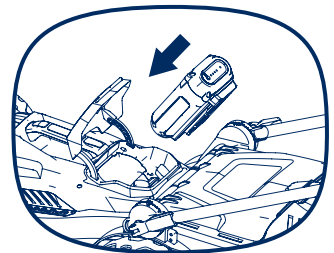

OPERATION

- ii. Insert the Safety-Key into assembly hole until you hear a click, then close the battery pack tank cover.

NOTE: This lawnmower is fitted with a safety key; this prevents the accidental start-up of your cordless lawnmower. The safety key has been designed to totally disable the lawnmower when it is removed.

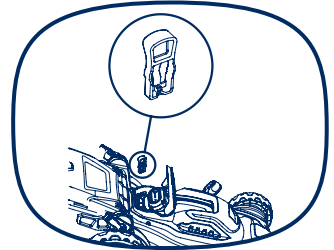

- iii. Press and hold the safety button on the side of the switch box with one hand. Pull the switch bar towards the handle and hold it with the other hand.

NOTE: When the machine is up and running, it is no longer necessary to keep pressing the safety button. We recommend that you use your other hand to secure the switch bar.

NOTE: Do not start the motor in tall grass. It may lock the blade and damage the motor.

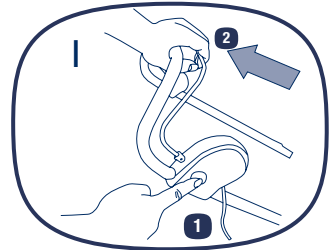

Switch off :

Release the switch bar.

NOTE: Do not continue to press the start button after an automatic shut-off of the machine, this will lead to battery damage.

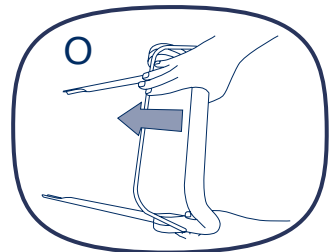

WARNING!

When the motor has been switched off, the blade will continue to run for several seconds. Do not touch the underside of the mower until the cutter has come to a complete standstill!

Using the mulching plug

When mulching, remove the collection grass bag, and put the plastic mulching plug into the rear discharge chute. Then release the flap, it will close back to cover the mulching plug.

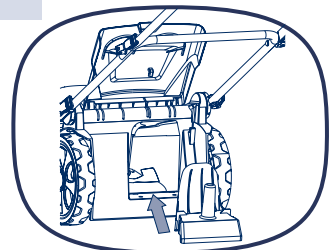

OPERATION

BATTERY PACK REMOVAL

Open the battery pack tank cover. Press the battery pack release button, and the battery pack will come out automatically.

NOTE: If the mower is to be placed in storage, ensure to remove the battery and store it correctly. For details, please refer to the battery pack section of the safety instructions.

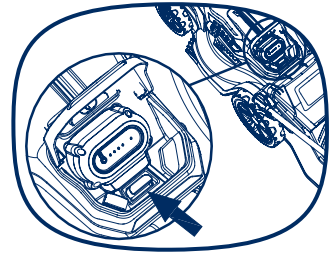

MOWING TIPS

- Verify that the lawn is free of stones, sticks, wires and other objects that could damage the lawnmower.
- When cutting thick grass, reduce walking speed for a more effective cut and a proper discharge of the clippings.
- Never cut off more than one-third of the total length of the grass for a healthy lawn. If it is roughly 6cm long, the grass should not be shorter than 4cm once mowed. If the grass is higher, you should gradually cut it down to the desired length so as not to damage the grass.
- Do not cut wet grass as it tends to stick to the underbody of the lawnmower, preventing the proper discharge of grass clippings.

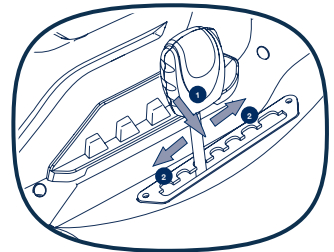

Cutting position	Cutting height
1	25mm
2	30mm
3	37mm
4	47mm
5	58mm
6	67mm
7	75mm

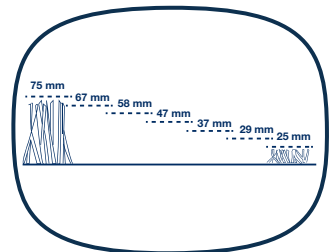

OPERATION

IMPORTANT NOTE

This mower is fitted with a motor thermal protection device to protect the motor when it (or the blade) shuts down (or blocks) during operation, for whatever reason.

Procedure to follow when the protection device is triggered:

- release the switch lever
- disconnect the extension lead
- check what caused the blade to suddenly come to a halt (clean the cutting chassis)

Mowing direction

- i. When mowing, follow the pattern for best results.

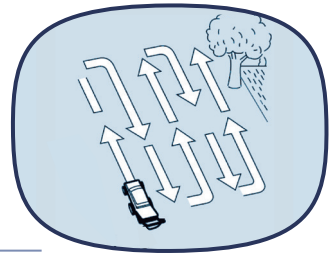

Grass bag full indicator

- i. If the collection bag is empty or it is not filled with grass, the grass full indicator will open.
- ii. If the collection bag is filled with grass, the grass full indicator will close.

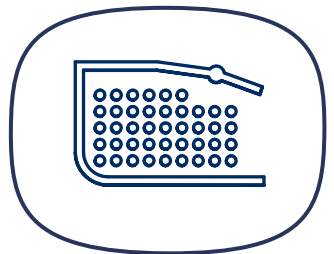
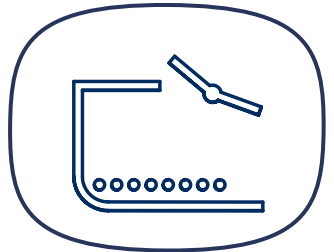

MAINTENANCE



WARNING!



Before performing any maintenance or cleaning work, always ensure that the battery pack/safety key has been removed. Wait until the blade has cooled down and all components have come to a complete stop.

- i. Keep the underbody and cutting blade clean and free of debris. Remove clippings from the discharge chute.
- ii. Regularly check nuts and bolts before operation. After prolonged use, especially in sandy soil conditions, the cutting blade will become worn and lose some of its original shape. The cutting efficiency will be reduced and the cutting blade should be replaced.
- iii. Lubricate the cutting blade after each use to prolong the lifespan of the cutting blade and product. Apply light machine oil along the edge of the cutting blade.

Replacing the cutting blade

Keep the cutting blade sharp to ensure optimum cutting performance. Replace a worn or damaged cutting blade with a new one of the same type or have it sharpened by a qualified specialist.

- i. Loosen the bolt anticlockwise using a suitable wrench and remove it together with the blade.
- ii. Replace the blade with a new one of the same type.
- iii. Reattach the blade onto the spindle, pay attention to correct alignment. Tighten the bolt clockwise with 16 Nm min, 20 Nm max. to ensure safe operation of your product.

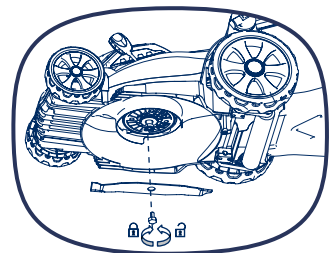

NOTE: Replace this cutting device after 50 hours mowing or 2 years whichever comes first, regardless of condition. If the cutting device is cracked or damaged, immediately replace it with a new one.

MAINTENANCE

Repair

This product does not contain any parts that can be repaired by the consumer. Contact an authorised service centre or a similarly qualified person to have it checked and repaired.

Storage

- Switch the product off and remove the battery pack from the mower.
 - Do not leave the battery pack in the charger.
 - Remove the charger plug when it is not in use.
 - Clean the product as described above.
 - To reduce storage space, the upper handle can be folded down, unscrew the wing nuts by approximately 6 revolutions.
 - We recommend using the original packaging for storage or use a suitable sheet or enclosure to protect the lawnmower from dust.
-
-

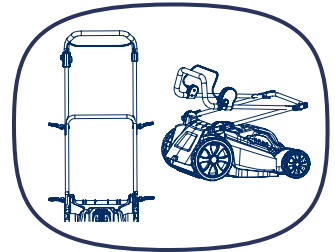

Battery maintenance

Use the following procedures to achieve the best battery life:

- Protect the battery against moisture and water.
 - Store the battery only within temperature range of 5°C to 45°C. Do not leave the battery in direct sunlight for extended periods of time.
 - Clean the battery regularly with a soft, clean and dry brush.
-

MAINTENANCE

- If you do not use the product for a long time, remember to charge and discharge the battery pack once every 6 months.
-
-

Transportation

- Switch the product off and remove the key and battery pack.
 - Protect the product from any heavy impact or strong vibrations which may occur during transportation.
 - Secure the product to prevent it from slipping or falling over.
-
-

Recycling and disposal

- The product comes in a package that protects it against damage during shipping. Keep the packaging until you are sure that all parts have been delivered and the product is functioning properly. Recycle the packaging afterwards.
- Old products are potentially recyclable and do belong in household rubbish. You are requested to assist us and our contribution to saving resources and protecting the environment by handing in this product at an equipped collection centre (if there is one available).



TECHNICAL DATA

Model	SCR3644A
Nominal voltage of product with battery	36V --- /4.0Ah Li-ion
No-load cutting speed	3400/min
Cutting width	44cm
Cutting height	25-75mm, 7 positions
Capacity of grass bag	50 L
Weight	19.9 kg
Battery pack Model	B0P-SP01-36AG
Battery capacity	4.0Ah
Battery charging time Max.	1.5hr
Battery charger Model	B0Q-SP01-4040ZI
Degree of protection	IPX1
Input	200-240V AC, 50/60Hz 180W
Output	40V ---, 4A
Charger protection class	II

PART NUMBER	ACCESSORIES
1450049000	Grass bag
1050874000	Lock handle
1252858000	Blade
0240154000	Charger
0240291000	Battery
1053923000	Mulching Plug

Sound values

Sound pressure level L_{pA} : 88dB(A), K_{pA} : 3dB(A)

Sound power level L_{WA} : 95.6dB(A), K_{WA} : 2.39dB(A)

Guaranteed sound power level L_{WA} : 96dB(A)

Vibration values

Hand arm vibration: $a_{h,w}$ =2.39 m/s²

Uncertainty: K=1.5m/s²

TECHNICAL DATA

The sound values have been determined according to noise test code given in EN 60335-2-77, using the basic standards EN ISO 11201 and EN ISO 3744.

The sound intensity level for the operator may exceed 80 dB(A) and ear protection measures are necessary.

The declared vibration value has been measured in accordance with a standard test method (according to EN 60335-2-77) and may be used for comparing one product with another. The declared vibration value may also be used in a preliminary assessment of exposure.



WARNING! Depending on the actual use of the product the vibration values can differ from the declared total! Adopt proper measures to protect yourself against vibration exposures. Take the whole work process including times the product is running under no load or switched off into consideration.

Proper measures include among others regular maintenance and care of the product and cutting attachments, keeping hands warm, periodical breaks and proper planning of work processes!

TROUBLESHOOTING

Suspected malfunctions are often due to causes that the user can fix themselves. Therefore, check the product using this section. In most cases the problem can be solved quickly.



WARNING! Only perform the steps described within these instructions! All further inspection, maintenance and repair work must be performed by an authorised service centre or a similarly qualified specialist if you cannot solve the problem yourself!

Gloves and appropriate protective clothing must be worn when performing these instructions.

Fault/malfunction	Cause	Remedy
Motor does not run	Safety key is not inserted	Insert safety key
	Battery is not correctly inserted	Remove the battery and reinsert
	Mower standing in high grass	Start motor on shorter grass or already mowed area, change cutting height if necessary
	The mower housing is clogged	Clean housing so that the blade can move freely
	Battery has no power	Check and recharge battery
Mower stops working/loses power	Cutting height is incorrect	Adjust the cutting height
	Cutting blade is worn or damaged	Replace with new blade from dealer service centre
	Battery performance decreasing	Check the battery performance and charge it if necessary
Grass bag is not filled sufficiently	Cutting height is too low	Adjust and increase cutting height
	The lawn / grass is wet	Allow the lawn to dry
	Underside of the mower deck is clogged.	Clean the underside of the mower deck
	Cutting blade is worn or damaged.	Replace it by contacting the customer service centre
Mower vibrating at higher speed.	Cutting blade is unbalanced.	Balance the blade by grinding each cutting edge until equal.
	Blade is loose /incorrectly fitted.	Tighten the blade bolt.
Mower cuts unevenly	The blade is damaged.	Sharpen the blade or replace.
	Blade is assembled incorrectly.	Re-assemble blade correctly.

WARRANTY

If your device develops a fault, please don't hesitate to contact our customer service department on 0345 605 2067, the majority of problems can be solved directly on the phone.

1. These warranty terms cover additional warranty rights and do not affect your statutory warranty rights. All our products are covered by a 3 year manufacturer warranty. The warranty period for battery pack and charger is 1 year.
2. Claims must be accompanied by proof of purchase. This must be in the form of a sales receipt or bank statement and must show that the product has been purchased within the warranty period as described under point 1, from the retailer that it was originally bought from. Please keep your receipt safe or staple it to the back of this manual for future reference.
3. Our warranty covers problems caused by material or manufacturing defects, and will result in the repair of these defects or replacement of the device with a like for like or similar article.
4. Our devices have not been designed for commercial, trade or industrial applications, any signs of use of the equipment in these application or equivalent activities, invalidates the warranty.
5. The following are also excluded from our warranty:
 - A. Faults due to accidents, customer misuse or unauthorised repairs
 - B. Consumable parts such as blades, quick release locks, battery pack, wheels, grass bags and other accessories that are compatible with the product.
 - C. Failure due to lack of routine maintenance.
 - D. Failure as a result of not using the equipment in accordance with the manual and safety instructions
 - E. The adjustment of cables, driver belts or switch box.

Warranty claims should be submitted before the end of the warranty period, see point 1, but a paid service exists for repairs commissioned after this period. The original warranty period remains applicable to the device even if repairs are carried out or parts are replaced. In such cases, the work performed or parts fitted will not result in an extension of the warranty period, and no new warranty will become active for the work performed or parts fitted.

If you have any problems or questions concerning your garden power tool, please contact our after sales service at 0345 605 2067.