

GB

20V CORDLESS GRASS TRIMMER

Original Instructions

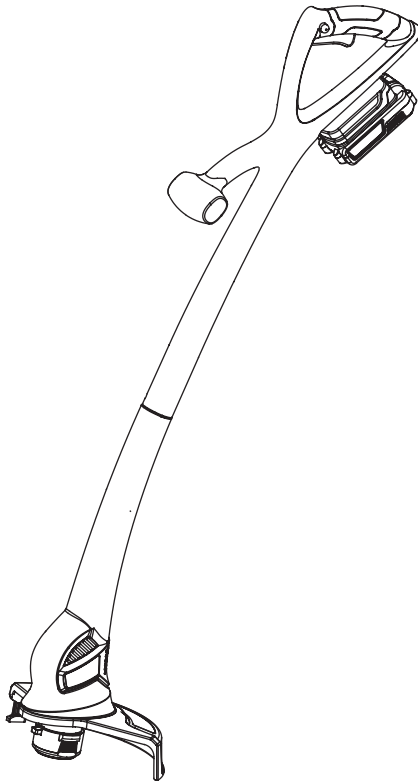

**READ & UNDERSTAND
INSTRUCTION MANUAL**

Save all warnings and instructions for future reference.

CE



UK
CA

A

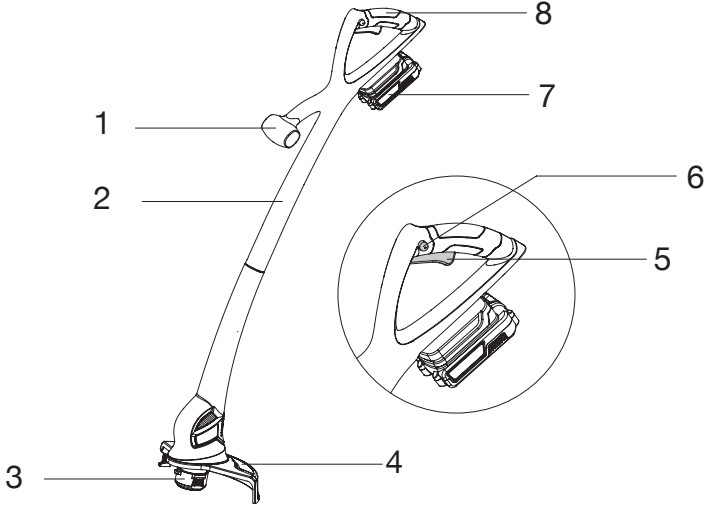

B

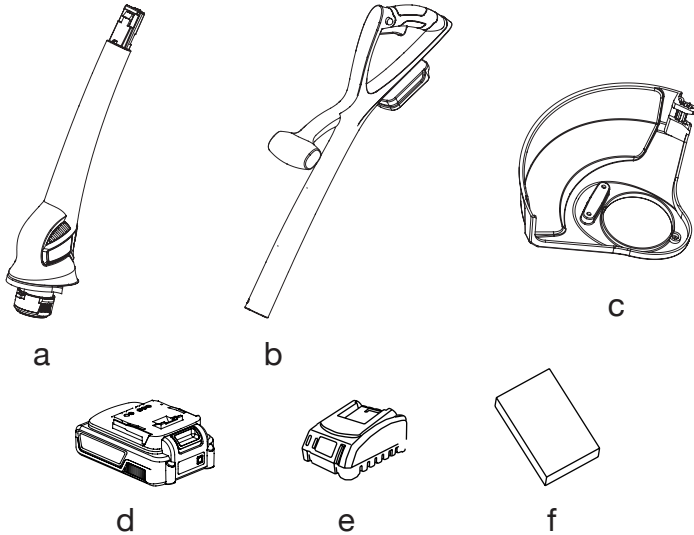

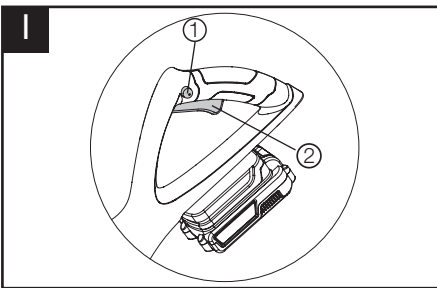
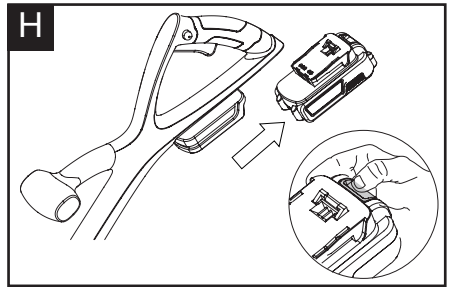
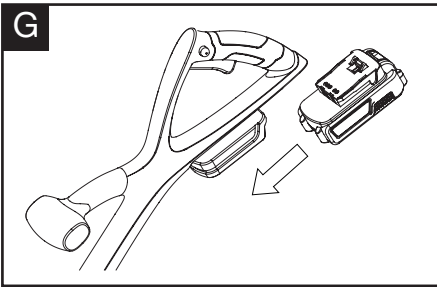
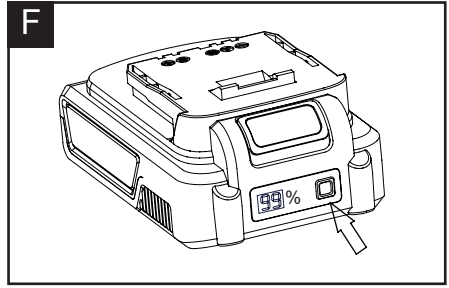
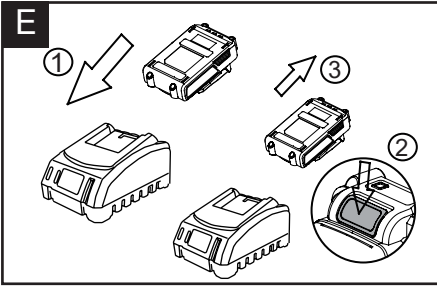
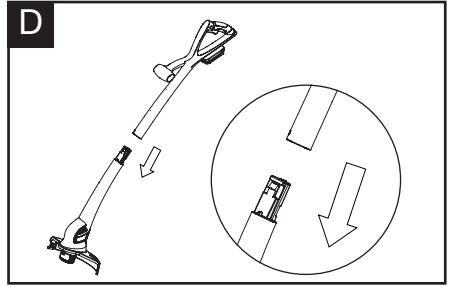
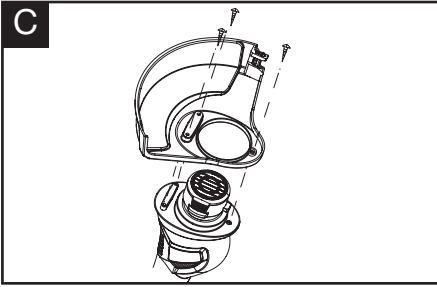

YARD FORCE

LT C25B Original Instructions

CONTENT

Intended use	06
General safety warnings	06
Product safety warnings	09
Symbols	14
Technical data	19
Description of product	18
Assembly	19
Operation	20
Maintenance and storage	23
Troubleshooting	24
CE & UKCA declaration	25

INTENDED USE

This Li-Ion cordless grass trimmer is intended for cutting weed, grass or similar soft vegetation in areas that are hard to reach, e.g. under bushes, on slopes and edges. It may not be used to work on unusual thick, dry or wet grass, e.g. pasture grass, or to shred leaves. For safety reasons it is essential to read the entire instruction manual before first operation and to observe all the instructions therein. This product is intended for private domestic use only, not for any commercial trade use. It must not be used for any purposes other than those described.

GENERAL SAFETY WARNINGS

WARNING: When using line trimmers, basic safety precautions should always be followed to reduce the risk of fire, electric shock, and personal injury, including the following:

Save all warnings and instructions for future reference.

DANGER: Do not rely on the tool's insulation against electric shock. To reduce the risk of electrocution, never operate the machine in the vicinity of any wires or cables (power, etc.) which may carry electric current.

TRAINING

1. Read the instructions carefully. Be familiar with the controls and the proper use of the machine.
2. Never allow people unfamiliar with these instructions or children to use the machine. Local regulations can restrict the age of the operator.
3. Keep in mind that the operator or user is responsible for accidents or hazards occurring to other people or their property.

GENERAL SAFETY WARNINGS

PREPARATION

1. Never operate the machine while people, especially children, or pets are nearby.
2. Wear eye protection and stout shoes at all times while operating the machine.
3. The distance between the machine and bystanders shall be at least 15m.
4. Do not use metal blades.
5. Avoid using the machine in bad weather conditions especially when there is a risk of lightning.

OPERATION

1. Use the machine only in daylight or good artificial light.
2. Never operate the machine with damaged guards or shields or without guards or shields in place.
3. Switch on the motor only when the hands and feet are away from the cutting means.
4. Always disconnect the machine from the power supply (i.e. remove the plug from the mains or remove removable battery).
 - Whenever leaving the machine unattended;
 - Before clearing a blockage;
 - Before checking, cleaning or working on the machine; after striking a foreign object;
 - Whenever the machine starts vibrating abnormally.
5. Take care against injury to feet and hands from the cutting means.

GENERAL SAFETY WARNINGS

6. Always ensure that the ventilation openings are kept clear of debris.

MAINTENANCE AND STORAGE

1. Disconnect the machine from the power supply (i.e. remove the plug from the mains or remove removable battery) before carrying out maintenance or cleaning work.
2. Use only the manufacturer's recommended replacement parts and accessories.
3. Inspect and maintain the machine regularly. Have the machine repaired only by an authorized repairer.
4. When not in use, store the machine out of the reach of children.

PRODUCT SAFETY WARNINGS

OTHER SAFETY WARNINGS

1. Avoid Dangerous Environments – Don't use trimmers in damp or wet locations.
2. Always turn the line trimmer off or remove the battery pack whenever leaving the trimmer unattended.
3. Don't Use In Rain.
4. Keep Children Away – All visitors should be kept at a distance from work area.
5. Dress Properly – Do not wear loose clothing or jewelry. They can be caught in moving parts. Use of rubber gloves and substantial footwear is recommended when working outdoors. Wear protective hair covering to contain long hair.
6. Use Safety Glasses – Always use a face or dust mask if operation is dusty.
7. Use the Right Tool – Do not use the tool for any job except that for which it is intended
8. Don't Force the Trimmer – It will do the job better and with less likelihood of a risk of injury at the rate for which it was designed.
9. Don't touch moving hazardous parts before the machine is turned off or removed the battery pack and the moving hazardous parts have come to a complete stop.
10. Don't Overreach – Keep proper footing and balance at all times.
11. Stay Alert – Watch what you are doing. Use common sense. Do not operate the trimmer when you are tired.

PRODUCT SAFETY WARNINGS

12. Do not operate the trimmer while under the influence of alcohol or drugs.
13. Keep guards in place and in working order.
14. Store Trimmer Indoors – When not in use the trimmer should be stored indoors in a dry and high or locked-up place with the battery pack removed – out of reach of children.
15. Maintain Trimmer With Care – Keep the cutting attachment clean for best performance and to reduce the risk of injury. Follow instructions for changing accessories. Keep handles dry, clean, and free from oil and grease.
16. Check Damaged Parts – Before further use of the trimmer, a guard or other part that is damaged should be carefully checked to determine that it will operate properly and perform its intended function. Check for alignment of moving parts, binding of moving parts, breakage of parts, mounting, and any other condition that may affect its operation. A guard or other part that is damaged should be properly repaired or replaced by an authorized service center unless indicated elsewhere in this manual.
17. Clear the area to be cut before each use. Remove all objects such as rocks, broken glass, nails, wire, or line that can be thrown or become entangled in the cutting attachment. Make sure that other persons and pets are at least 15m away.
18. Before using the machine and after any impact, check for signs of wear or damage and repair as necessary.

PRODUCT SAFETY WARNINGS

19. Always hold the trimmer firmly, with both hands on the handles while operating. Wrap your fingers and thumbs around the handles.
20. Avoid Accidentally Starting–Don't carry the trimmer with your finger on the trigger.
21. Do not operate the trimmer in petrolic or explosive atmospheres. Motors in these appliances normally spark, and the sparks might ignite fumes.
22. Damage to Trimmer – If you strike a foreign object with the trimmer or it becomes entangled, stop the tool immediately, remove the battery pack from the line trimmer, check for damage and have any damage repaired before further operation is attempted. Do not operate with a broken guard or spool.
23. If the equipment should start to vibrate abnormally, stop the motor, remove the battery pack from the line trimmer, and check immediately for the cause. Vibration is generally a warning of trouble. A loose head may vibrate, crack, break or come off the trimmer, which may result in serious or fatal injury. Make sure that the cutting attachment is properly fixed in position. If the head loosens after fixing it in position, replace it immediately. Never use a trimmer with a loose cutting attachment.
24. Replace a cracked, damaged or worn-out cutting head immediately, even if damage is limited to superficial cracks. Such attachments may shatter at high speed and cause serious or fatal injury.
25. Check the cutting attachment at regular short intervals during operation, or immediately if there is a noticeable change in cutting behavior.

PRODUCT SAFETY WARNINGS

26. Only use Yard force authorized polymer trimmer line accessories and trimmer line that are designed for use with this machine. Although certain unauthorized attachments might be fitted to the Yard force line trimmer, their use may be extremely dangerous, and/or damaging to the tools.
27. To reduce the risk of serious injury, never use wire or metal-reinforced line or other material in place of the nylon cutting lines. Pieces of wire could break off and be thrown at high speed toward the operator or bystanders.
28. To reduce the risk of injury from loss of control, never work on a ladder or on any other insecure support. Never hold the cutting attachment above waist height.
29. If situations occur that are not covered in this manual, use care and good judgment. Contact the Yard force Service Center for assistance.
30. Do not charge the battery pack in rain, or in wet locations.
31. Use only with Yard force battery packs and chargers.
32. The battery pack must be removed from the appliance before it is scrapped.
33. The battery shall be disposed of safely.
34. Do not dispose of the battery in a fire. The cells may explode. Check with local authorities for possible special disposal instructions.
35. Do not open or mutilate the battery. Released electrolyte is corrosive and may cause damage to the eyes or skin. It may be toxic if swallowed.

PRODUCT SAFETY WARNINGS

36. Exercise care in handling batteries in order not to short the battery with conducting materials such as rings, bracelets, and keys. The battery or conductor may overheat and cause burns.
37. When servicing, use only identical Yard force replacement parts. Use of any other accessory or attachment may increase the risk of injury.
38. Battery tools do not have to be plugged into an electrical outlet; therefore, they are always in operating condition. Be aware of possible hazards even when the tool is not operating. Take care when performing maintenance or service.
39. Do not wash with a hose; avoid getting water in motor and electrical connections.
40. Save these instructions. Refer to them frequently and use them to instruct others who may use this tool. If you loan this tool to someone else, also loan these instructions to them to prevent misuse of the product and possible injury.
41. Always wear substantial footwear and long trousers while operating the machine.
42. Always be sure of the footing on slopes and to walk, never run.

Safety symbols

The purpose of safety symbols is to attract your attention to possible dangers. The safety symbols and the explanations with them require your careful attention and full understanding. The symbol warnings do not, by themselves, eliminate any danger. The instructions and warnings they give are no substitutes for proper accident prevention measures.

WARNING: Be sure to read and understand all safety instructions in this operator's manual, including all safety alert symbols such as "**DANGER**," "**WARNING**," and "**CAUTION**" before using this tool. Failure to follow all instructions listed below may result in electric shock, fire and/or serious personal injury.

SAFETY ALERT SYMBOL: Indicates **DANGER**, **WARNING**, or **CAUTION**. May be used in conjunction with other symbols or pictographs.

Symbol meaning

This page depicts and describes safety symbols that may appear on this product. Read, understand and follow all instructions on the machine before attempting to assemble and operate.

SYMBOLS



This symbol, before a safety comment, indicates a precaution, a warning or a danger. Ignoring this warning can lead to an accident for yourself or for others. To limit the risk of injury, fire, or electrocution always apply the recommendations indicated.



To reduce the risk of injury, user must read the instruction manual carefully.



Wear protective goggles.



Wear suitable protective gloves.



Wear ear protection



Wear a dust mask.



Wear foot protection



Protect against rain and wet.
Do not expose and operate the tool in rain.

SYMBOLS



Ensure that other people and pets remain at least 15m away from the line trimmer when it is in use.

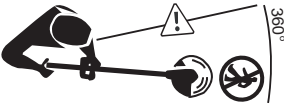

Beware of thrown or flying objects to bystanders. Keep bystanders a safe distance away from the machine.

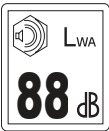

Guaranteed sound power level value in 88 dB.







WEEE symbol. Waste electrical products should not be disposed of with household waste. Please recycle where facilities exist. Check with your Local Authority or local store for recycling advice.



The product complies with the applicable European directives and an evaluation method of conformity for these directives was done.

TECHNICAL DATA

Model		LT C25B
Mains voltage		20 V ===
No load speed		10000 min ⁻¹
Cutting width		250 mm
Cutting line dia.		1.2 mm
Sound power level: L _{WA}		85 dB(A)
Guaranteed sound power level L _{WA} (according to 2000/14/EC)		88 dB(A)
Vibration front handle		2.0 m/s ² K=1.5 m/s ²
Weight:		1.6 kg

The declared vibration total value has been measured in accordance with a standard test method and may be used for comparing one tool with another;

The declared vibration total value may also be used in a preliminary assessment of exposure.

NOTICE: The vibration emission during actual use of the power tool can differ from the declared value in which the tool is used. In order to protect the operator, user should wear gloves and ear protectors in the actual conditions of use.

DESCRIPTION OF PRODUCT

Parts description (Fig. A)

1. Front handle
2. Upper tube
3. Line spool
4. Safety guard
5. Main switch
6. Safety lock button
7. Battery pack
8. Main handle

Delivery contents (Fig. B)

Carefully unpack the appliance and check that it is complete. Dispose of the packaging material correctly.

- a. Garss trimmer unit
- b. Upper handle
- c. Guard
- d. Battery pack
- e. Charger
- f. Instruction manual



WARNING: If any parts are damaged or missing, do not operate this tool until these parts are replaced. Failure to heed this warning could result in serious personal injury.



NOTE: Always recycle the packaging in accordance with local recycling guidelines.

ASSEMBLY

WARNING: If any parts are damaged or missing, do not operate this product until the parts are replaced. Use of this product with damaged or missing parts could result in serious personal injury.

WARNING: Do not attempt to modify this product or create accessories not recommended for use with this line trimmer. Any such alteration or modification is misuse and could result in a hazardous condition leading to possible serious personal injury.

WARNING: To prevent accidental starting that could cause serious personal injury, always remove the battery pack from the tool when assembling parts.

Attaching the guard (Fig. C)

1. Remove four mounting screws from motor housing.
2. Fit the safety guard onto the motor housing.
3. Fix the safety guard in place by using the four screws.

Installing upper handle (Fig. D)

Align the front handle with the upper tube. connect each other, make sure they are locked in to place.

OPERATION

Charging the battery pack

NOTE: Remove the battery pack from the charger after it has been fully charged.

NOTE: Battery should be fully charged before first use.

NOTE: Make sure the mains voltage is the same as rating label which is located on the charger.

1. Connect the charger to a power supply. Red LED will light up.
2. To insert the battery pack into the charger, align the raised ribs of the battery pack with the grooves of the charger then push it in. **(Fig. E)**
3. The red LED light of the charger will light up and then the green light flashes during normal charging.
4. After charging is complete, the charger light will turn to a solid green light.
5. Once the battery is fully charged, depress the battery release button and then remove the battery pack. **(Fig. E)**

Power indicator (Fig. F)

This Li-Ion battery pack is equipped with a power indicator which is used to show the battery pack's remaining charge. Press the power indicator button to check battery charge as picture showed. The indicator will stay lit for approximately 4 seconds.

To obtain the best life from the battery

1. Never allow the battery to completely discharge before recharging. The battery pack should be placed on the charger whenever the battery pack is noticeably running down or the tool no longer performs a task it previously performed.
2. Avoid conducting short charges. Make sure that the battery is fully charged each time by allowing the charger to complete its full charging cycle.
3. Avoid allowing loose items like screws or nails etc. to be stored with battery packs as these or similar items can short battery packs and cause a fire or explosion.
4. Always unplug the charger when not in use and store in a dry and secure place.
5. Avoid charging or storing your battery in temperatures below 5°C and above 45°C.
6. After use, allow the battery pack to cool down for approximately 30 minutes before attempting to recharge.

Attaching/Detaching the battery pack

Fully charge before first use.

To Attach

Align the battery ribs with the mounting slots and press the battery pack down until you hear a "click". **(Fig. G)**

OPERATION

To Detach

Depress the battery-release button and pull the battery pack out. (Fig. H)

WARNING: Dress properly to reduce the risk of injury when operating this tool. Do not wear loose clothing or jewelry. Wear eye and ear/hearing protection. Wear heavy duty, long trousers, boots and gloves. Do not wear short trousers, sandals or go barefoot.

Before operating, look around you to ensure a safety working area without other people, animals or any loose objects. And then check for eye protection, proper clothing and balanced footing.

STARTING/STOPPING THE LINE TRIMMER

To Start (Fig. I)

Press down the lock-off lever and hold it in that position. Depress the trigger to start.

To Stop

Release the trigger.

NOTE: Always remove the battery pack from the line trimmer during work breaks and after finishing work.

Automatic line feeding

The equipment features a fully automatic single line system. The lines will automatically elongate every time you turn on the appliance. To support proper line elongation, ensure that the coil has stopped moving completely before turning on the appliance again. The lines are automatically cut to the correct length by the line cutter.

Trimming

1. Ensure the knife protector label is removed before use. Ensure you wear gloves when removing this label.
2. Adjust the trimmer head angle to a proper position for trimming operation.
3. Hold the grass trimmer firmly, keeping your balance with feet slightly apart. Alter the height of the product if needed to ensure an upright posture.
4. Hold the trimmer head just above the ground at an angle of approximately 30°.
5. Move the product slowly from side to side in a swinging motion.
6. Ensure the cutting device remains clean and free from off-cuts that may cause it to jam. Check regularly. Release the on/off switch and take the battery pack off before checking.
7. Trim longer grass in stages; do not cut long grass in one cut. For the best results, cut longer grass in steps.
8. Place the trimmer along the edge of the lawn.
9. Turn product on and push the trimmer forward slowly.

OPERATION

Tips

1. For best results, do not cut wet grass as it tends to stick to the cutting head and guard, prevents proper discharge of grass trimmings and could cause you to slip and fall.
2. Do not allow the spool cover to drag on the ground or other surfaces.
3. Pay special attention when performing work close to trees and bushes. The cutting head could damage sensitive bark, and damage fence posts.
4. Fold the plant protector out to avoid bringing the cutting device into contact with hard objects such as walls and curbstones.

NOTE: The trimming line will wear faster and require more feeding if the cutting or edging is done along sidewalks or other abrasive surfaces or heavier weeds are being cut.

Replacing the spool

1. Press together both locking device tabs on the spool cover and remove the cover.
2. Remove the old spool from the spool cover.
3. Clean out any dirt or grass residue.
4. Put the new spool in the spool housing, thread the line into the hole.

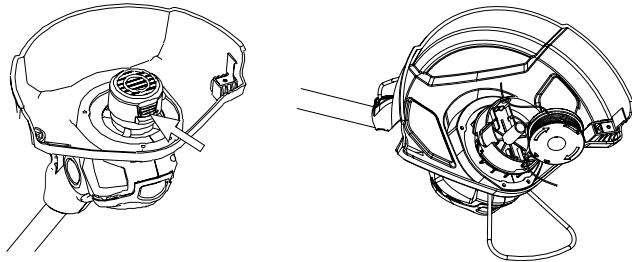

Winding the line

NOTE: Should you wish to wind the line yourself, the instructions are provided below: Self-winding, however, is NOT recommended because if the line is not wound properly it can cause the trimmer's feed system to malfunction. For this reason, users are strongly urged to purchase the pre-wound spool.

1. Hold the loose ends of the line together with one hand, insert one end of the line into the groove on the spool.
2. Wind the line following the directional arrows on the spool housing and hook the two ends into the side grooves.

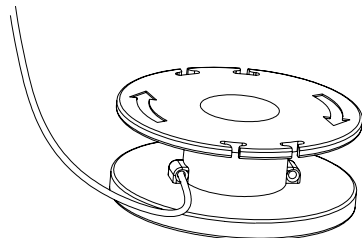

MAINTENANCE AND STORAGE

WARNING: Before performing any repair work, always remove the battery pack and wait until the cutting blade has come to a standstill.

CLEANING

1. Clean the unit using a damp cloth with a mild detergent.
2. Do not use any strong detergents on the plastic housing or the handle. They can be damaged by certain aromatic oils, such as pine and lemon, and by solvents such as kerosene. Moisture can also cause a shock hazard. Wipe off any moisture with a soft dry cloth.
3. Use a small brush or the air discharge of a small vacuum cleaner brush to clean the air vents on the rear housing.

STORING THE UNIT

1. Remove the battery pack from the line trimmer when it is not in use.
2. Clean the tool thoroughly before storing it.
3. Store the unit in a dry, well-ventilated area, locked-up or up high, out of the reach of children. Do not store the unit on or adjacent to fertilizers, petrol, or other chemicals.

Transport

Use the original packaging to ship whenever possible.

MAINTENANCE AND STORAGE

Fault/malfunction	Cause	Remedy
Line trimmer fails to start	The battery pack is not attached to the line trimmer.	Attach the battery pack to the line trimmer
	No electrical contact between the trimmer and battery.	Remove battery, check contacts and reinstall the battery pack.
	The battery pack is depleted	Charge the battery pack.
	The lock-off lever and trigger are not depressed simultaneously.	Press down the lock-off lever and hold it, then depress the trigger to turn on the line trimmer.
Line trimmer stops while cutting	The motor shaft or trimmer head is bound with grass.	Stop the trimmer, remove the battery, and remove the grass from the motor shaft and trimmer head.
	The motor is over-loaded	Remove the trimmer head from the grass. The motor will recover to work as soon as the load is removed. When cutting, move the trimmer head in and out of the grass to be cut and remove no more than 20cm of length in a single cut.
	The battery pack or line trimmer is too hot.	Allow the battery pack or trimmer to cool until the temperature drops below 50°C.
Trimmer head will not advance line	The motor shaft or trimmer head is bound with grass.	Stop the trimmer, remove the battery, and remove the grass from the motor shaft and trimmer head.
	There is not enough line on the spool.	Remove the battery and replace the cutting line

DECLARATION OF CONFORMITY

To the provisions of Council Directives

We

SUMEC UK

**Unit A&B Escrick Business Park Escrick, York YO19 6FD
United Kingdom**

Declare that the product:

Description: 20V Grass Trimmer

Model No. LT C25B

Function: cutting Grass

Complies with the essential health and safety requirements of the following directives:

Supply of Machinery (Safety) Regulations 2008

Electrical Equipment (Safety) Regulations 2016

The Restriction of the Use of Certain Hazardous Substances in Electrical and Electronic Equipment Regulations 2012

Noise Emission in the Environment by Equipment for use Outdoors Regulations 2001 Relative Notified Body (GB/8500/0184/21 Issue 1):

AnP Certification Limited

2, Parkfield Street Manchester M14 4PN

Measured Sound Power Level: 85 dB(A).

Guaranteed Sound Power Level: 88 dB(A).

Standards and technical specification referred to:

For Appliance:

EN 60335-1:2012+A12

EN 50636-2-91:2014

EN IEC 55014-1:2021

EN IEC 55014-2:2021

For Charger:

EN 60335-1:2012+A11+A13+A14+A2

EN 60335-2-29:2004+A2+A11

EN 55014-1:2017+A11

EN 55014-2:2015

EN IEC 61000-3-2:2019

EN 61000-3-3:2013+A1

EN 62233:2008

Authorized Signatory

Date: 18.01.2023



Signature: _____

Place: York

Name: Mariana Hall

General Manager

SUMEC UK Co.,Ltd.

Unit A&B Escrick Business Park

Escrick, York YO19 6FD

United Kingdom



CE DECLARATION

To the provisions of Council Directives

We
MEROTEC GmbH,
Otto-Brenner-Straße 8,
47877 Willich/ Deutschland

Declare that the product:
Description: 20V Grass Trimmer
Model No. LT C25B
Function: cutting Grass

Complies with the essential health and safety requirements of the following directives:

Machinery Directive 2006/42/EC

Electromagnetic Compatibility Directive 2014/30/EU

EC Directive 2011/65/EU and its amendment Directive (EU) 2015/863 (RoHS)

Noise Directive, amended by 2005/88/EC conformity assessment procedure: 2000/14/EC Annex VI

Measured Sound Power Level: 85 dB(A).

Guaranteed Sound Power Level: 88 dB(A).

Standards and technical specification referred to:

For Appliance:

EN 60335-1:2012+A12

EN 50636-2-91:2014

EN IEC 55014-1:2021

EN IEC 55014-2:2021

For Charger:

EN 60335-1:2012+A11+A13+A14+A2

EN 60335-2-29:2004+A2+A11

EN 55014-1:2017+A11

EN 55014-2:2015

EN IEC 61000-3-2:2019

EN 61000-3-3:2013+A1

EN 62233:2008

Authorized Signatory

Date: 23.01.2023

Signature: _____



Place: Willich

Name: Roland Menken

General Manager

MEROTEC GmbH,
Otto-Brenner-Straße 8,
47877 Willich/ Deutschland

